

University of British Columbia

Social Ecological Economic Development Studies (SEEDS) Sustainability Program

Student Research Report

# East Mall Redesign Project

Prepared by: Matthew Addison, Adam Letendre, Jade Lissel, Nicholas Schwartz, John Schwarz, Zika Trajkovic,  
Nicole Whitmore

Prepared for:

Course Code: CIVL 446

University of British Columbia

Date: 16 April 2021

*Disclaimer: "UBC SEEDS Sustainability Program provides students with the opportunity to share the findings of their studies, as well as their opinions, conclusions and recommendations with the UBC community. The reader should bear in mind that this is a student research project and is not an official document of UBC. Furthermore, readers should bear in mind that these reports may not reflect the current status of activities at UBC. We urge you to contact the research persons mentioned in a report or the SEEDS Sustainability Program representative about the current status of the subject matter of a report".*



## **East Mall Redesign Project**

**Matthew Addison**

**Adam Letendre**

**Jade Lissel**

**Nicholas Schwartz**

**John Schwarz**

**Zika Trajkovic**

**Nicole Whitmore**

**University of British Columbia**

**CIVL 446**

**April 16<sup>th</sup>, 2021**

*Disclaimer: "UBC SEEDS Sustainability Program provides students with the opportunity to share the findings of their studies, as well as their opinions, conclusions and recommendations with the UBC community. The reader should bear in mind that this is a student research project/report and is not an official document of UBC. Furthermore, readers should bear in mind that these reports may not reflect the current status of activities at UBC. We urge you to contact the research persons mentioned in a report or the SEEDS Sustainability Program representative about the current status of the subject matter of a project/report"*

# Table of Contents

Table of Contents	ii
List of Figures	iv
List of Tables	iv
Executive Summary	v
1.0 Introduction	1
1.1 Site Description	1
1.2 Project Objectives	3
1.3 Project Components	4
1.4 Team Member Contributions	5
2.0 Key Issues and Constraints	6
2.1 Stakeholder Engagement	6
2.2 Permitting	6
2.3 Technical	6
2.4 Utilities	7
2.5 Economic	7
2.6 Construction Planning	7
2.7 Environmental	8
3.0 Preferred Design	8
3.1 Intersection Improvements	8
3.1.1 Stadium Rd	8
3.1.2 Eagles Dr	9
3.1.3 Thunderbird Blvd	10
3.1.4 Sopron Ln	11
3.1.5 Agronomy Rd	11
3.2 Active and Sustainable Transportation	12
3.3 Pick-up Drop-off	13
3.4 Canopy	14
3.5 Water Management System	15
3.5.1 South of Agronomy to Thunderbird Blvd.	16
3.5.2 South of Thunderbird Blvd. to Eagles Dr.	16
3.5.3 Drop-off Bay	16
3.5.4 South of Stadium Rd. to W16th Ave.	17

3.6 Construction Equipment and Materials	17
4.0 Design Rationale	19
4.1 Traffic Analysis	19
4.1.1 Existing Conditions	19
4.1.2 Future Conditions	19
4.1.3 Projected Land Use Changes	19
4.1.4 Model Results	20
4.1.5 Traffic Improvements	22
4.1.6 Improved Model Results	23
4.2 Safety Analysis	23
4.3 Active and Sustainable Transportation	24
4.4 Pick-up Drop-off	27
4.5 Canopy	27
4.6 Geotechnical Considerations	28
4.6.1 Desktop Study	28
4.6.2 Site Conditions	29
4.7 Water Management	30
4.8 Sustainability Considerations	31
5.0 Service-life Maintenance Plan and LCA	32
5.1 Canopy	32
5.2 Road and Sidewalks	34
5.3 Water Management System	34
6.0 Construction Work Plan	35
6.1 Construction Schedule	35
6.2 Requirements	36
6.3 Issues	36
7.0 Cost Estimate	37
8.0 Conclusion	38
9.0 References	39
Appendix A - Schedule	40
Appendix B - Cost Estimate	42
Appendix C - Structural Design Calculations	44
Appendix D - SAP2000 Analysis	49

Appendix E - Rain Garden Calculations	53
Appendix F - Soil Classification	56
Appendix G - Synchro Report Sample	58
Appendix H - Technical Drawing Package	61

## List of Figures

Figure 1: Location of UBC in Greater Vancouver region, taken from Google Maps .....	1
Figure 2: Project site boundaries, taken from Google Maps .....	1
Figure 3: East Mall and Eagles Dr intersection, taken from Google Earth .....	2
Figure 4: Photos from site visit to East Mall showing parking, painted bike lane (right) and unused space between centre median and travel lane (left) .....	2
Figure 5: Thunderbird AM Recommended Signal Timing Plan .....	11
Figure 6: Thunderbird PM Recommended Signal Timing Plan .....	11
Figure 7: Agronomy AM and PM Recommended Signal Timing Plan .....	12
Figure 8: Bicycle crossing with green pavement treatment and elephant's feet markings .....	13
Figure 9: UBC Vancouver Campus Land Use Plan .....	20
Figure 10: Protected Intersection Key Features taken from BCATG Figure G-90 .....	26
Figure 11: Transit Stop Elements taken from BCATG Figure H-136 .....	26
Figure 12: Earthquake Liquefaction Susceptibility, Geomap Vancouver, 1998 .....	30

## List of Tables

Table 1: Team Member Contributions .....	5
Table 2: Key Material Requirements for Construction .....	18
Table 3: Synchro Intersection Results .....	21
Table 4: SimTraffic Intersection Results .....	21
Table 5: Improved Synchro Intersection Results .....	23
Table 6: Improved SimTraffic Intersection Results .....	23
Table 7: Service Life of Canopy Components .....	33
Table 8: Cost Breakdown by Project Phase .....	38

# Executive Summary

East Mall is a key North-South collector road which connects West 16th Ave to the UBC Campus. The study area extends along East Mall from West 16th Ave to Agronomy Road. It is adjacent to multiple sports fields and facilitates vehicle pick-up drop-offs for the many users the fields see. In the future, East Mall will be the main connecting road to the new stadium neighbourhood to be developed at the south-west end of East Mall. This project aims to redesign East Mall with the following benefits.

- Prioritized active modes of transportation by improving the safety of the roadway for cyclists, pedestrians, and busses
- Adding a designated pickup drop-off area to help ease the traffic demand along the adjacent fields
- Addition of pedestrian weather protection at the Agronomy intersection
- Increased stormwater retention on-site

These goals will be met with the following infrastructure. Northbound right and Southbound left turning bays will be implemented at Thunderbird Blvd to improve traffic flow with a semi-actuated signal installed at Agronomy Road. All intersection crossings will be improved to enhance pedestrian and cyclist safety when crossing. A pedestrian weather protection canopy, which ties in to the local architecture, will be installed at the Agronomy intersection to improve the pedestrian experience along the East Mall corridor. Uni-directional fully separated cyclist lanes will be added to increase cyclist safety and ensure the infrastructure is accessible for all ages and abilities. Lastly, an integrated stormwater management system will be implemented, which will focus on modifying existing green space into bioswales and rain gardens for increased stormwater retention on-site.

The selected design has an estimated final cost of **\$2,760,000**, with an expected project completion date of August 27th, 2021.

# 1.0 Introduction

## 1.1 Site Description

The site is located at the University of British Columbia in the Greater Vancouver region of British Columbia, Canada. The major intersections in this project scope are Agronomy Rd, Thunderbird Blvd, Eagles Dr, and Stadium Rd shown in the figures below.

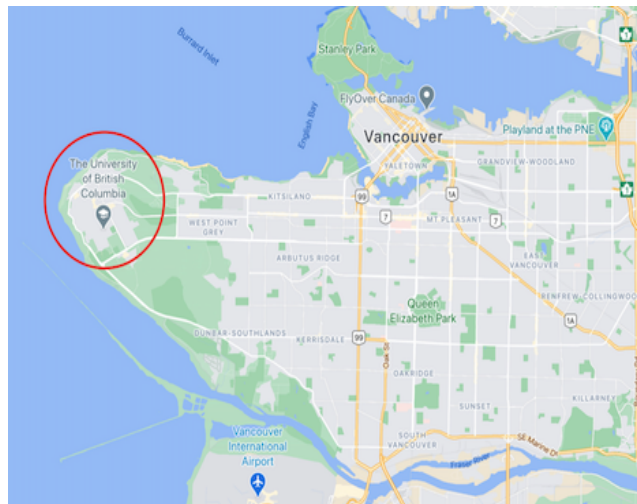

Figure 1: Location of UBC in Greater Vancouver region, taken from Google Maps

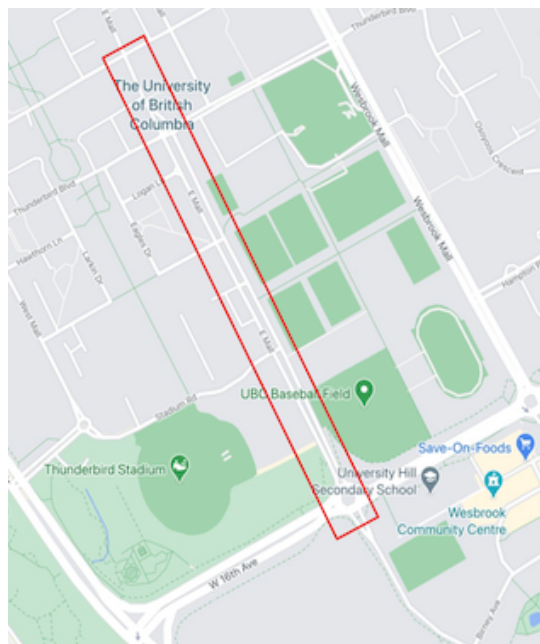

Figure 2: Project site boundaries, taken from Google Maps

The curb-to-curb road width varies from approximately 30m (south of Thunderbird) to 7m (north of Agronomy). There is a large centre median with a maximum width of 9m (varies according to left turn lanes) from Thunderbird Blvd to W 16th Ave.



*Figure 3: East Mall and Eagles Dr intersection, taken from Google Earth*

There are pedestrian crossings located at Stadium Rd, Eagles Dr, Thunderbird Blvd, Sopron Ln, and Agronomy. The only signalized intersection is at Thunderbird Blvd. The pedestrian crossings south of Thunderbird Blvd are very wide, while those north of Thunderbird Blvd are relatively short. These are only treated with signage and zebra pavement markings.



*Figure 4: Photos from site visit to East Mall showing parking, painted bike lane (right) and unused space between centre median and travel lane (left)*



There are narrow painted bike lanes (1.5m) from 16th Ave to Thunderbird Blvd, which disappear north of Sopron Ln. On-street parking is located on both sides of East Mall from 16th Ave to Thunderbird Blvd, and off-street parking is available through UBC maintained parkades, (Thunderbird and Health Sciences parkades located nearby). North-bound (NB) left-turn bays are located at the Stadium Rd, Eagles Dr intersection, as well as the FPIInnovations access. The surrounding land use varies from institutional, recreational, and residential. The most notable pattern is the sports facilities located on the east side of East Mall from Thunderbird Blvd to 16th Ave. Pick-up and drop-off for these facilities will be a key part of the design. The west side of East Mall south of Stadium Rd will feature a large new development, which will increase transportation volumes in the area and will be accounted for in the trip generation portion of our design.

## 1.2 Project Objectives

The stretch of East Mall road from West 16th Ave. to Agronomy road is a very busy stretch due to a number of fields and sporting facilities bordering the road, as well as providing access to the Thunderbird and Health Sciences parkades. The primary causes of traffic along this road come from commuters and parents picking-up and dropping-off their children for recreational activities. Additionally, there are existing plans to narrow a significant portion of the East Mall road cross section to accommodate plans for the Stadium Neighborhood. For these reasons, a redesign of East Mall from West 16th Ave. to Agronomy Rd. has been approved. The primary goals of this project is to increase the safety for all road users, meet the demands of the adjacent fields and facilities, accommodate the plans for Stadium Neighborhood, and to implement on-site stormwater management measures to minimize movement of stormwater off-site. Active modes of transportation, such as walking and biking, will be prioritized to keep the project in line with the UBC Transportation Guide and objectives for sustainable transportation options.

## 1.3 Project Components

To ensure the five primary project objectives were met, our design features a number of specific design components. Firstly, for pedestrians traveling along Agronomy road, we have designed a canopy to be installed along the south face of the Gerald McGavin building. The canopy provides overhead cover for the full sidewalk width and conforms to all Vancouver building by-laws. Next, to accommodate and encourage active modes of transportation, our design includes protected bike lengths down the length of the project site, transitioning to neighborhood bikes zones at the project boundary north of the Agronomy Road intersection. Increased sidewalk widths have also been added to accommodate high pedestrian traffic. Additionally, the bus stops located on either side of Eagles Dr. intersection will feature a pedestrian refuge island, accessible by pedestrian priority zebra crossings. Next, our design features a number of intersection upgrades. At the Agronomy Road intersection, in order for our design to meet the predicted future traffic volumes, we have upgraded from an unsignalized control to a semi-actuated traffic signal control. Additionally, at the Thunderbird Blvd. intersection, we elected to add a left turning lane in the southbound direction and a right turn lane in the northbound direction. For the full length of the corridor, curb extensions, reduced cur radii, double curb ramps, detectable surfaces on all curb ramps and Rectangular Rapid Flashing Beacons (RRFBs) for the Stadium Road and Eagles Drive intersections have been added. One of the largest upgrades our design features is the inclusion of a designated drop-off bay for the recreational fields adjacent to the project site. It will be located on the northbound side East Mall Road, featuring two lanes, one for travel through, running adjacent to a 5-min parking lane. Sharp entrance and exits help control speed, as well as a 15 km/hr speed limit within the bay's extents. Finally, to take advantage of the abundance of green space on site, extensive green stormwater management measures have been added in the way of rain gardens and bioswale. Surface runoff will be directed to these features where water will be simultaneously redirected into existing UBC stormwater infrastructure, while also being able to pond and infiltrate back into the ground.

## 1.4 Team Member Contributions

Table 1: Team Member Contributions

Member Initials	Team Member Number	Key Contributions
M.A.	1	<ul style="list-style-type: none"> <li>● Material recycling plans</li> <li>● Detailed construction management plans</li> <li>● Drop-off/Pick-up Bay design</li> <li>● Cost estimate</li> </ul>
A.L.	2	<ul style="list-style-type: none"> <li>● Transportation specialist, completed synchro analysis, safety analysis and signal design</li> <li>● AutoCAD design of roadway, signage, pavement markings, intersections, and plan view</li> </ul>
J.L.	3	<ul style="list-style-type: none"> <li>● Structural specialist, pedestrian weather protection calculations and detailed design</li> <li>● Construction scheduling and cost estimate refinement</li> <li>● Responsible for the LCAs</li> </ul>
N.S.	4	<ul style="list-style-type: none"> <li>● Water resources calculations for detailed design</li> <li>● Cost estimate and schedule</li> <li>● Site description, key constraints and issues</li> </ul>
J.S.	5	<ul style="list-style-type: none"> <li>● Water resources calculations for detailed design</li> <li>● Responsible for water related drawings</li> <li>● Key constraints and issues</li> </ul>
Z.T.	6	<ul style="list-style-type: none"> <li>● Transportation specialist, focused on the active transportation design and plan view drawings</li> <li>● AutoCAD design of roadway, signage, pavement markings, intersections, and plan view</li> </ul>
N.W.	7	<ul style="list-style-type: none"> <li>● Geotechnical considerations and assessment</li> <li>● Cross-Section design and drawings</li> <li>● Drop-off/Pick-up Bay design</li> <li>● Standard details drawings</li> </ul>

## 2.0 Key Issues and Constraints

### 2.1 Stakeholder Engagement

This design has considered the needs and knowledge provided by key stakeholders as they were consulted throughout the design process. Stakeholders include the UBC community, University Neighbourhood Association along East Mall, and the University Endowment Lands. Additionally, we recognize that the project is located on the traditional ancestral, and unceded lands of the Musqueam Territory, as such they were consulted throughout the process. Key utilities providers, such as Fortis, have been included for excavation planning.

### 2.2 Permitting

Permits are required for this project to ensure all components comply with the minimum standards outlined by the federal, provincial, and local governments. The permits that have been submitted to the City of Vancouver include an Awning Permit for the canopy, Demolition Permit for the existing road, and Tree Removal Permit. Also, a right of way permit has been submitted to Fortis BC in order to safely excavate near potential gas lines. In accordance with the UBC Campus and Community Planning Department, a Streets and Landscape Permit (SLP) was required, which ensures that any changes made to the existing landscape comply with the Land Use Plan, Vancouver Campus Plan, Neighbourhood Plans, and campus guidelines and standards. Additionally, the project must adhere to the provincial standards and requirements outlined by the FRPA to ensure the protection of the surrounding plants, animals, and ecosystems. An archaeological assessment has been performed to protect the historical and cultural value of the site, with nothing of significance being found.

### 2.3 Technical

The major technical considerations for this project have been the existing and future developments on either side of East Mall, limiting the corridor right-of-ways for cross-section

improvements. Our design needed to smoothly tie-in with the existing roadways to the North, and the future frontage development connected to the Stadium neighbourhood. A critical design element is the pick-up/drop-off zone adjacent to the sports fields which needed to meet significant traffic demands and ensure safety of all users. Furthermore, there are a number of objectives that had to be met, including catering to multiple modes of transportation and ensuring vehicle traffic flow is maintained while enhancing pedestrian, cyclist and public transport experiences along the corridor.

## 2.4 Utilities

A number of public utilities are below the existing roadway and central median, the shallowest electrical conduits being 0.6m below ground. Fortis gas lines are also a major construction consideration and will be properly located before any construction begins. The construction plans will focus on removing existing surface asphalt, curb and gutters, and sidewalks to a maximum depth below ground of approximately 0.3m to maintain adequate cover above utilities.

## 2.5 Economic

Throughout the design, the decisions made have focused on minimizing the cost of each phase. As the client is representing a public entity, funds must be allocated responsibly, and transparency is essential.

## 2.6 Construction Planning

Construction staging will be necessary as the existing transportation corridor along East Mall cannot be blocked off for extended periods of time. The design has accounted for this logistical consideration and the impact on budget and time estimates. A full breakdown of how this is addressed is included in section 6.

## 2.7 Environmental

A key consideration within the design was to incorporate a “wilderness” aesthetic by maintaining as many existing trees as possible and maximizing green space throughout the corridor.

Sediment control plans during and after construction, along with biological considerations, have been considered in accordance with governing regulations. Stormwater management infrastructure is designed to meet the UBC Integrated Stormwater Management Plan and Metro Vancouver guidelines. Minimizing and treating stormwater runoff from site will be done with bioswales and rain gardens placed within the medians and along sidewalks, respectively. Additionally, life-cycle assessments have been considered within the design and recycling of construction materials has been included where feasible.

## 3.0 Preferred Design

Refer to Appendix H for the detailed technical drawings of the preferred design components listed below.

### 3.1 Intersection Improvements

#### 3.1.1 Stadium Rd

The Stadium Rd intersection transitions the cross-section provided by the Stadium Neighbourhood development into the preferred cross-section northwards. A 3.5m wide and 20.0m long north-bound (NB) left-turn bay is being added on the south leg of the intersection. Road space for this was created by offsetting the NB through traffic by using a 3.5m wide painted yellow buffer according to the City of Vancouver Standard Detail Drawing R8.2. The intersection remains unsignalized and employs a Rapid Rectangular Flashing Beacon on the south leg of the intersection, which was shown to have the highest volume of pedestrian traffic from our Syncro modeling. The intersection remains stop-controlled with free-flowing north-south traffic, and a stop sign located on the Stadium Rd approach.

Pedestrian crosswalks are located on north, south, and west legs of the intersections, while bicycle crossings are located adjacent to the West and South pedestrian crosswalks.

Pedestrians are provided with a 3.0m wide crosswalk, and cyclists receive a 2.5m wide crossing with green pavement treatment according to the City of Vancouver Engineering Design Manual Table 9-19: Green Treatment Uses. Adjacent cyclist and pedestrian crossings include a 0.9m buffer. Crossing distances at the north, south, and west legs are 8.5m, 10.5m, and 7.0m respectively. Curb ramps are located on either ends of all active transportation crossings. There are four pedestrian/cyclist crossings with a 2.5m width, which will implement zebra pavement markings to signalize pedestrian priority according to the City of Vancouver Engineering Design Manual 8.8.1.4. Other pedestrian infrastructure to enhance safety include double curb ramps, detectable surfaces on curb ramps, curb extensions, and shortened curb radii.

### 3.1.2 Eagles Dr

The Eagles Dr intersection will be unsignalized and employs a Rapid Rectangular Flashing Beacon on the north leg of the intersection. The intersection remains stop-controlled with free-flowing north-south traffic, and a stop sign located on the Eagles Dr approach. A 3.5m wide and 20.0m long NB left-turn bay is added on the south leg of the intersection.

Pedestrian and cyclist crossings are located on the north and west side of the intersection.

Pedestrians are provided with a 3.0m wide crosswalk, and cyclists receive a 2.5m wide crossing with green pavement treatment. Adjacent cyclist and pedestrian crossings include a 0.9m buffer. Crossing distances at the north and west legs are 15.0m and 6.0m respectively. Curb ramps are located on either ends of all active transportation crossings. There are five pedestrian-cyclist crossings, no longer than 2.5m, which will implement zebra pavement markings to signalize pedestrian priority. Two are located on either end of the 3.0m wide bus refuge areas for pedestrians. The bike lanes approaching the pedestrian-cyclist crossing near the bus stops will

feature additional signage for cyclists to yield to pedestrians. Red pavement treatment will mark the bus pull-in zone for pedestrian pick-up and drop-off, including bus priority pavement markings according to the City of Vancouver Standard Detail Drawing R8.8. Other pedestrian improvements include double curb ramps, detectable surfaces on curb ramps, curb extensions, and shortened curb radii.

A painted yellow buffer is implemented to offset NB through traffic to align with the north lane alignment. The vehicles exiting the dedicated pick-up and drop-off for the sports facilities have a stop sign to yield to incoming NB traffic before merging into the travel lane.

### 3.1.3 Thunderbird Blvd

At the Thunderbird intersection 3.0m wide pedestrian crossings are located on all sides. Double curb ramps are located at each side of the intersection equipped with detectable surfaces. As well, 2.5m wide cyclist crossings with green pavement treatment are provided on the east and west sides. Adjacent cyclist and pedestrian crossings include a minimum 0.9m buffer. The pedestrian refuge areas between the cyclist lanes and traffic lanes are all greater than the minimum width of 2.5 m. The curb radius has also been reduced on all sides to encourage slower turning speeds. There is a 25 m left turning lane on the southbound approach, an existing 50m left turn lane on the westbound approach and a 20m right turn pullout on the northbound approach. Signage has been added to the intersection in accordance with the British Columbia Manual of Standard Traffic Signs & Pavement Markings.

The intersection uses a semi actuated traffic signal with a protected turning phase for westbound lefts in the PM peak only. The signal timing plans shown in Figures 5 and 6 are recommended with a cycle length of 40 seconds in the AM and 65 seconds in the PM.



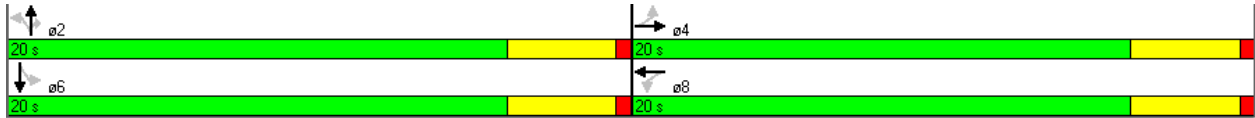

Figure 5: Thunderbird AM Recommended Signal Timing Plan

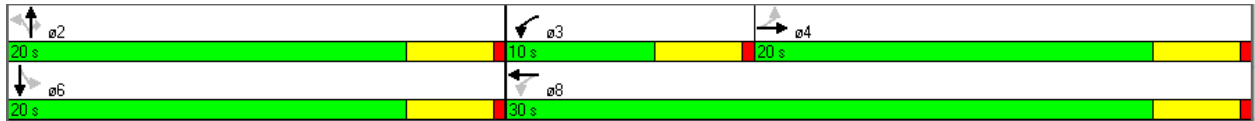

Figure 6: Thunderbird PM Recommended Signal Timing Plan

### 3.1.4 Sopron Ln

Sopron Ln features a mid-block 3.0m wide pedestrian crossing between Thunderbird Blvd and Agronomy Rd. The south end of the crossing utilizes the narrowing median to feature a 2.5m pedestrian refuge island between the cyclist and vehicle crossing. The full crossing distance for the south and west legs are 15.0m and 8.0m respectively and are treated with signage and pavement markings in accordance with the British Columbia Manual of Standard Traffic Signs & Pavement Markings. As East Mall continues northward the ROW narrows and the protected cyclist facilities transition from a 2.5m wide grade-separated protected bike lane to a 2.5m wide on-grade painted bike lane to help transition to the neighbourhood bikeway north of Agronomy. The transition is marked with Reserved Bicycle Lane Ends/Begins signage and No Stopping signage. The west approach will remain stop controlled and maintain its restriction to provide access to emergency and service vehicles only.

### 3.1.5 Agronomy Rd

At the Agronomy Road intersection 3.0m wide pedestrian crossings are located on all sides. Double curb ramps are located at each side of the intersection equipped with detectable surfaces. A curb extension is used on the south side to reduce the crossing width. The curb radius has also been reduced on all sides. The painted shoulder cycle lanes on East Mall,

approaching Agronomy from the south, transition to a shared neighborhood bikeway just before the Agronomy Road intersection. All other approaches also utilize neighborhood bikeways.

The intersection will be upgraded to a semi actuated signal and for both the AM and PM peak a 40 second cycle length is recommended with the signal timing plan shown in Figure 7.

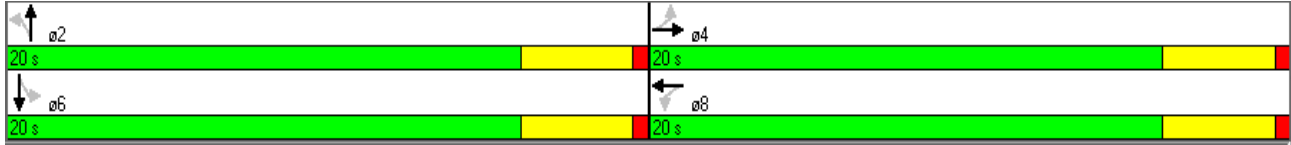

Figure 7: Agronomy AM and PM Recommended Signal Timing Plan

### 3.2 Active and Sustainable Transportation

The preferred design features physically separated uni-directional bike lanes from Sopron Ln to W 16th Ave. They have an average width of 2.5m north of Stadium, tapering down to 1.8m south of Stadium to accommodate the Stadium neighbourhood proposed cross-section design.

Bike lanes are physically separated from vehicular traffic by a minimum 0.9m wide green median and are also separated from pedestrians by a minimum 0.9m vegetated area which increases to 1.5m to accommodate for a tree boulevard. For areas where the existing curb is maintained, the bike facility is at road grade, whereas for areas where the curb is being rebuilt, the bike facility is at grade with the sidewalk.

According to the City of Vancouver Engineering Design Manual Section 8.8, for intersection zones where vehicular and bicycle traffic may conflict, the pavement for cyclist crossings is treated with green paint and elephant feet pavement marking, as shown in Figure 8. For zones where pedestrian and bicycle traffic may conflict, the pavement is treated with zebra crosswalk markings to indicate pedestrian priority. At all pedestrian and cyclist crossings that are grade separated from the road, curb ramps are employed for accessibility and comfort.



*Figure 8: Bicycle crossing with green pavement treatment and elephant's feet markings*

Existing sidewalks that are 1.8m or below will be extended to 3.0m wide where possible. Pedestrian sidewalks on both sides from Agronomy to Thunderbird and on the east side between Thunderbird and Eagles Dr will remain as is. All other sidewalks will be rebuilt to accommodate a 3.0m width for safety and comfort. The bushes adjacent to the east sidewalk south of Thunderbird Blvd will be removed to increase visibility and create space for sidewalk widening.

For the two bus stops located on either side of Eagles Dr, a 3.0m wide pedestrian island is located from the curb to accommodate pedestrian queuing and a bus shelter. The sidewalk is also maintained adjacent to the island to avoid unnecessary pedestrian and cyclist conflicts. The bike lane is narrowed to 2.3m adjacent to the bus stops, and a 0.3m buffer is on either side of the bike lane to separate pedestrians and cyclists.

A more detailed description for these design choices and lengths can be found in Section 4 of the report.

### 3.3 Pick-up Drop-off

One of the key objectives of the East Mall Redesign project is to provide a safe and effective drop-off zone for the surrounding sporting facilities and growing stadium neighbourhood. Our design incorporates a 155m designated drop-off zone adjacent to the sporting fields from Stadium Rd to Eagles Dr. The drop-off zone will consist of two lanes which are separated from the main traffic route by a 1m median. The 3m right hand lane will allow vehicle users to

temporarily pull over and stop to drop off passengers while the 3.5m left hand lane is for northbound travel and safely rejoins vehicle traffic along East Mall. Installing a designated drop-off zone will prevent traffic backups and improve traffic flow during peak demands by providing 25, 5-minute maximum drop-off spots. In addition to improving vehicular traffic flow, the drop-off section will provide improved safety for pedestrians and cyclists by providing separation from traffic flow. Also, the pick-up/drop-off lane incorporates sharp entry and exits that act as vehicle speed reduction measures to further improve the safety of pick-up drop-off users. The posted speed limit throughout the bay will be 15 km/hr.

### 3.4 Canopy

To provide pedestrian weather protection along Agronomy Road, a canopy will be installed on the South face of the Gerald McGavin building, between Health Sciences Mall and East Mall. The canopy projects 2.5m from the building, is 7.2m long, and will be installed at a vertical height of 2.75m above grade, which conforms with the canopy requirements outlined in Section 1.8.8. of the City of Vancouver Building By-law No. 10908. The canopy features lightweight, durable aluminum framing and polycarbonate panels, and effectively integrates with the architecture of the building and the surrounding area. It uses five W200X46 aluminum I-beams spaced at 1.8m perpendicular to the face of the building, supported by HSS6”X4”x0.125” aluminum beams located at the front and back of the frame. The aluminum beams are all Aluminum Alloy 6061 heat treated and aged to improve strength. The front beams are divided into segments to span between the webs of each of the aluminum I-beams, and the entire canopy slopes 5 degrees towards the aluminum drain beam at the back of the frame to collect excess water from the top of the canopy. The drain beam will be installed at a slight angle to allow water to flow towards a 2” by 2” aluminum square gutter downpipe to provide drainage, reducing the potential for moss and algae buildup. The downpipe will be installed along the facade of the building and guide water away from the foundation through perforated pipes.

Decking will consist of 16mm translucent Polycarbonate panels connected to 2" by 2" aluminum angles that run along the perimeter of the upper surface of the canopy. The panels will be aligned and secured to the aluminum frame and will be properly sealed to the perimeter angles to prevent any water leakage off the side of the canopy. All framing fasteners will be A325 stainless steel bolts with neoprene washers, which will be coated to increase the service life. The canopy will undergo regular maintenance to preserve the quality and maintain the appearance of the materials. See detailed drawings for the elevation and plan views as well as the connection details in Appendix H.

The design loads for the canopy were designed based on load requirements outlined in NBCC 2015 Division B, Part 4. BCBC 2018 Division B, Part 4 was referenced for climatic data for Vancouver. Minimum values for vertical height and clearances defined in the City of Vancouver Building By-law No. 10908, Section 1.8.8 informed the dimensions of the canopy. CSA Standard S6 was considered in the structural design of the bolted connections. Given that canopies are lightweight and the seismic loads are typically very small, it was assumed that the canopy would not be subjected to significant lateral forces. The canopy is attached to and supported by the Gerald McGavin building, which will absorb the forces imposed by an earthquake. Detailed load calculations and a sample shear connection calculation can be found in Appendix C, and screenshots of the frame analysis from SAP2000 can be found in Appendix D.

### 3.5 Water Management System

Stormwater is to be managed by two distinct items. For the full project site, the medians in the road centre will be converted into bioswales, and the green area between the sidewalk and bike lane will be turned into rain gardens. The one exception to this is the road section south of Agronomy to Thunderbird Blvd. (see 3.5.1). For detailed information, please see drawings W.1 - W.4. The bioswales within the central medians slope downwards towards a base planted with

native vegetation. The water will then seep through 25cm of soil, through a 25cm sand filter, then into a 50cm rock trench. Excess stormwater that does not infiltrate will flow through a 150mm diameter PVC pipe into the existing stormwater outflow system. The rain gardens will provide a similar function containing runoff in a 50cm rock trench under 25cm of soil. Similarly, a 150mm PVC perforated pipe located at the top of the rock trench will transfer overflow to the existing drainage system. To help control erosion, bioswales will have flat road shoulders and have a 50cm buffer before sloping. Inlets to the rain gardens will be lined with river rock to control erosion of the soil. All trees will remain in place where the cross-section of the road is not being modified to help maintain the wilderness aesthetic. The widths of the rain gardens shown are typical of the cross-section but will vary between 1.5m-2.5m to accommodate other requirements.

### 3.5.1 South of Agronomy to Thunderbird Blvd.

This section has no median, and instead contains a 3.5m wide bioswale on either end of the roadway. See drawing W.4.

### 3.5.2 South of Thunderbird Blvd. to Eagles Dr.

This section contains a 9m wide bioswale in the median, 2m rain gardens on the west sidewalk, and 2.5m rain gardens on the east sidewalk.

### 3.5.3 Drop-off Bay

This section contains a 4m wide bioswale for the road runoff, and 2m rain gardens between the bike lanes and sidewalks. This area has a larger impervious-pervious ratio, therefore the bioswale will need a deeper rock trench to compensate. The drop-off bay does not have room to drain into the bioswale or rain garden and will require two catch basins to catch stormwater.

### 3.5.4 South of Stadium Rd. to W16th Ave.

No additional stormwater management techniques will be added to this section. This is due to the current stadium neighbourhood redesign already planned and is assumed this development will manage their stormwater accordingly.

## 3.6 Construction Equipment and Materials

In order to implement the proposed redesign of the East Mall corridor, a number of different construction equipment and materials are required. Firstly, traffic management equipment will be required to set up the road closures and traffic detours in order to maintain pedestrian, cyclist and motorist safety. After the project traffic management plan has been implemented to ensure the safety of the public the construction phases of the project will begin where heavy construction equipment will be necessary to complete the required work. The contractor will be required to supply but it is not limited to excavators, front end loaders, dump trucks, compactors, bulldozer, grader and curbing/paving equipment in order to effectively complete the road improvements. Excavators will be used as the main workhorse for removal of existing road sections onsite as well as the excavation of boulevards and placement of new road base materials and landscaping details. Front end loaders will be required to play a supporting role of moving stockpiled material around the project site as well as loading trucks to haul material offsite. Dump trucks will play an important role in hauling material on and offsite. A bulldozer and grader will be used to assist in placing road base materials to the proper elevations according to the road drainage design while compactors will be used for achieving the required proctor compaction. Finally, curbing and paving equipment are needed to place the new curbing and asphalt according to the East Mall redesign.

In addition to the required heavy equipment, large quantities of construction materials will be required to complete the project. Large quantities of 75mm and 20mm road base will make up the foundation of the road and will be required for the redevelopment of the roadway and intersections. 20mm clear crush rock is needed for the foundation material for the new concrete sidewalks. In addition, 20mm clear will be used as a permeable fill material for bioswales and rain gardens. Stockpiled topsoil on site will be required for the construction of boulevard and landscaping elements of the project. Asphalt meeting the BC Ministry of Transportation and Infrastructure standard specifications for highway construction will be required for repaving the improved roadway and bike lanes. Lastly, concrete will be required for the construction of the redesigned curb lines as well as the pedestrian sidewalks. Key materials for construction are shown in Table 2.

*Table 2: Key Material Requirements for Construction*

<b>Material</b>	<b>Quantity</b>	<b>Unit</b>
Road Base 75mm Minus	3,600	Cub.m.
Road Base 19mm Minus	2,250	Cub.m.
Curb and Gutter	2,615	L.m.
Sidewalk	2,800	Sqr.m.
Asphalt Paving	1,680	Cub.m.

The above listed equipment and materials are key to the construction phases of the project; however, additional equipment and materials may be required. See section 5.0 for further discussion on the service-life and life cycle analysis of the construction materials.



## 4.0 Design Rationale

### 4.1 Traffic Analysis

#### 4.1.1 Existing Conditions

The existing traffic volumes were taken from the turning movement counts (TMC) counts provided by the client. These traffic volumes show a traffic trend along East Mall of northbound flow in the AM and southbound flow in the PM. This trend occurs due to morning commuters turning from 16 Ave onto East Mall to access the UBC facilities to the north.

#### 4.1.2 Future Conditions

The roadway performance was analyzed in both its existing condition and future condition for the year 2040. To develop future trip volumes, we have assumed a growth rate of 1.2% per year which is the projected growth in student enrollment from the UBC Transportation Plan. The rate matches well with the generally accepted regional traffic growth rate of 1% to 2%.

In our analysis we utilized two separate growth scenarios, one with vehicles and active transportation modes, and another with only active transportation modes. The second scenario was selected because the UBC Transportation plan shows a decrease in personal vehicle trips, and an increase in active transportation modes. The UBC Transportation Plan also identifies reduction of auto trips and an increase in trips by other modes as one of its key future objectives. The second scenario, with 0% traffic growth, is considered UBC's goal scenario, and the first scenario, which includes 1.2% auto growth, is included for conservative analysis.

#### 4.1.3 Projected Land Use Changes

Due to the proximity of the new Stadium neighborhood we added additional projected traffic, pedestrian and cyclist volumes to account for this development. To determine the additional volumes, we used the Institute of Transportation Engineers' (ITE) trip generation rates

(trips/unit) for a mid-rise apartment to determine the number of trips that the 1000-unit development will generate. These new trips were then distributed across modes using the mode share in the UBC Transportation plan. Finally, the new trip volumes were distributed across the network using the existing traffic patterns. The Stadium Neighborhood trips were distributed across both future growth scenarios.

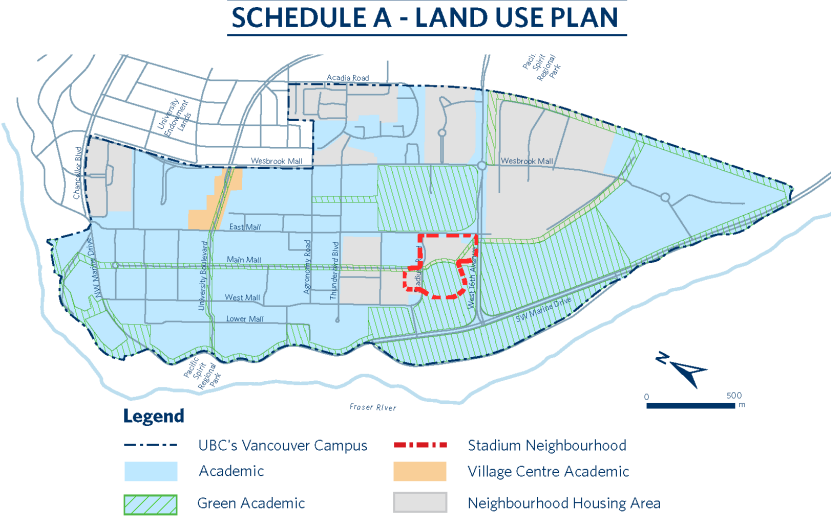

Figure 9: UBC Vancouver Campus Land Use Plan

### 4.1.4 Model Results

The Synchro LOS results for all scenarios are presented in Table 3 below. Stadium is performing very well at LOS A in all scenarios. Agronomy and Thunderbird receive LOS B at all times except for the PM peak of the traffic growth scenario, where it received LOS C. An example Synchro report is available in Appendix G and full reports are prepared and available upon request.

Table 3: Synchro Intersection Results

Synchro LOS	Agronomy		Thunderbird		Stadium	
	AM	PM	AM	PM	AM	PM
Existing	B	B	B	B	A	A
Future (No Traffic Growth)	B	B	B	B	A	A
Future (With Traffic Growth)	B	C	B	C	A	A

SimTraffic was also used to analyze the intersections. As you can see in Table 4 below, LOS F is reached at Agronomy Road in the AM and PM peaks for both future growth scenarios. These delays are caused by high pedestrian volumes blocking vehicles from moving through the unsignalized 4-way stop intersection. At Thunderbird Blvd and Stadium Road, in the traffic growth scenario, the LOS E and F results in the AM are caused by the northbound traffic queue at Agronomy Road becoming long enough to spill back into the Thunderbird and Stadium intersections.

Table 4: SimTraffic Intersection Results

SimTraffic Delays/Veh (s)	Agronomy		Thunderbird		Stadium	
	AM	PM	AM	PM	AM	PM
Existing	C	C	A	B	A	A
Future (No Traffic Growth)	F	F	A	B	A	A
Future (With Traffic Growth)	F	F	E	B	F	A

## 4.1.5 Traffic Improvements

To improve the intersections, we propose the following upgrades:

1) Agronomy Road Traffic Signal - SimTraffic showed unacceptable delays at Agronomy Road in both future traffic growth scenarios. To improve this intersection, we are upgrading from an unsignalized control to a semi-actuated traffic signal control which will allow the large north and south traffic volumes to move through the intersection in their own phase, without being constantly blocked by pedestrian movement.

### 2) Thunderbird Blvd Improvements

- a. Westbound Protected Turning Phase – One of the main reasons for the Synchro LOS C in the PM peak of the 1.2% traffic growth scenario is large delays for the westbound left. By adding a protected phase, the large amount of westbound left traffic will be able to move through the intersection efficiently without queueing.
- b. Southbound Left Turning Lane – When the westbound left phase is added to the signal timing plan it takes time away from other movements. This affects the southbound traffic the most since it is the heaviest in the PM peak. To compensate, a left turn bay was added to prevent a large southbound queue from forming. As well, there is ample space for a left turn bay and construction will already be occurring at this location for cyclist upgrades.
- c. Thunderbird Blvd Northbound Right Turning Lane – While the model results do not show a need for a right turn bay, there is space to add a short pullout bay since there is a parking lane which ends at this intersection. The large

volumes of right turning vehicles currently using this movement support this decision.

#### 4.1.6 Improved Model Results

The Synchro and Simtraffic results with improvements are shown in Table 5 and Table 6 below. As you can see the Synchro results for Agronomy Road and Thunderbird Blvd have increased from LOS B&C to LOS A&B. The Simtraffic results for Agronomy Road have increased from LOS F to LOS A with the addition of the traffic signal. At Thunderbird Blvd and Stadium Road, in the traffic growth scenario, the LOS E and F results in the AM are improved to LOS A.

*Table 5: Improved Synchro Intersection Results*

Improved Synchro LOS	Agronomy		Thunderbird		Stadium	
	AM	PM	AM	PM	AM	PM
Future (No Traffic Growth)	A	A	A	B	A	A
Future (With Traffic Growth)	A	B	A	B	A	A

*Table 6: Improved SimTraffic Intersection Results*

Improved SimTraffic LOS	Agronomy		Thunderbird		Stadium	
	AM	PM	AM	PM	AM	PM
Future (No Traffic Growth)	A	A	A	B	A	A
Future (With Traffic Growth)	A	B	B	B	A	A

## 4.2 Safety Analysis

The speeds along East Mall were analyzed using a client provided CTS tube count speed summary conducted over 7 days in October 2018 on East Mall between Thunderbird Blvd. and Eagles Dr. The summary shows an average mean speed of 44 km/hr and an average 85th

percentile speed of 53 km/hr. With 15% of users driving above the speed limit of 50 km/hr, there is a need for speed reduction along the corridor. Due to COVID-19 safety implications, the sightlines were not analyzed since sightline analysis requires on site visits. Current pedestrian crossings include a mix of single and double curb ramps and do not include detectable surfaces. As well, the curb radii are large at most intersections which encourages high turning speeds. Crossing distances are in the range of 20m to 30m which exposes pedestrians to potential incidents for a long period of time. The intersections of Stadium Dr and Eagles Dr support large pedestrian crossing movements without any form of signalized warning devices. To increase safety each intersection will be upgraded using the following recommendations, as per the BCATDG.

1. Curb extensions will be added to reduce speeds and reduce pedestrian crossing distances (BCATDG G50)
2. The curb radius of all intersections will be reduced to slow traffic turning speeds and to help make pedestrians more visible (BCATDG G12)
3. Double curb ramps will be added to reduce intersection crowding and orient pedestrians in their desired direction for travel, which is especially important for pedestrians using mobility devices (BCATDG G45).
4. Detectable surfaces will be added to each intersection letdown to increase accessibility (BCATDG G7).
5. RRFB's will be added to the Stadium Road and Eagles Drive intersections to increase driver awareness of pedestrians and cyclists (BCATDG G100)

### 4.3 Active and Sustainable Transportation

Our design upgrades the existing painted bike lanes along East Mall to protected bike lanes from W 16th Ave to immediately south of the Agronomy intersection. According to the BC Active

Transportation Guide (BCATG) Section D.3 - Protected Bicycle Lanes, protected bicycle lanes should be the preferred design treatment for posted motor vehicle speed at 50km/h and motor vehicle volumes greater than 4,000 vpd. According to the provided volume data, East Mall currently experiences well over 4,000 vpd on weekdays, averaging 7,000 vpd. Two unidirectional bike lanes were selected over a single bi-directional bike lane to better tie-in with the Stadium Neighbourhood cross-section and avoid potential conflicts associated with a unidirection to bi-direction transition at the Stadium intersection.

Design widths for the bicycle through zone, street buffer zone, and furnishing zone (between pedestrians and cyclists) were taken from 'Table D-11 // Protected Bicycle Lane Width Guidance' in Section D.3 for BCATG. This informed our design widths for a 2.5m wide bike lane width, a 0.9m wide street buffer zone, and a 2.0m wide furnishing zone where possible. The values listed above are desirable widths and maintained along the majority of our site. For areas where space was constrained, we did not go below the constrained limit provided in BCATG Table D-11.

The desired pedestrian through zone (sidewalk width) was informed by 'Table C-5 Pedestrian Through Zone Recommended Widths. Applying the table yields a desirable width for 2.4m for multi-family residential on a collector/arterial road type. However, a 3.0m wide sidewalk is recommended for areas of high pedestrian activity (defined by 400 pedestrians/peak 15-minute period). In the absence of pedestrian volume data, the excess of road space, and our project objectives to improve active transportation, our design aims for a 3.0m wide pedestrian through zone. Curb ramps are also an essential design component for pedestrians to increase accessibility for people using mobility devices, wheelchairs, strollers, additionally acting as a navigational tool for people with visual impairments. Curb ramps will be designed according to Section G.3 - Pedestrian Crossings of the BCATG, as well as the City of Surrey Design Criteria Manual R.26.



Figure 10: Protected Intersection Key Features taken from BCATG Figure G-90

Intersection design focuses on providing adequate crossings for vulnerable road users to improve safety and comfort. Our design follows the recommendations in G.3 of the BCATG and employs pavements markings such as twin parallel line crosswalks for signalized intersections, and zebra crosswalks for unsignalized intersections and RRFB crossings to improve visibility according to the City of Vancouver Standard Detail Drawings R8.9. Crossing lengths are minimized by employing curb bulges and providing refuge at centre medians where possible. Our bikeway intersection crossings were informed by section G.4 On-Street Bikeway Crossings. This includes providing green pavement treatment as per the City of Vancouver Design Criteria Manual to increase safety and visibility and employing elephant feet pavement markings on either side of the bicycle crossing. Adjacent cyclist and pedestrian crossings are buffered by 0.9m in accordance with the Pavement Markings standard details in the BCATG.

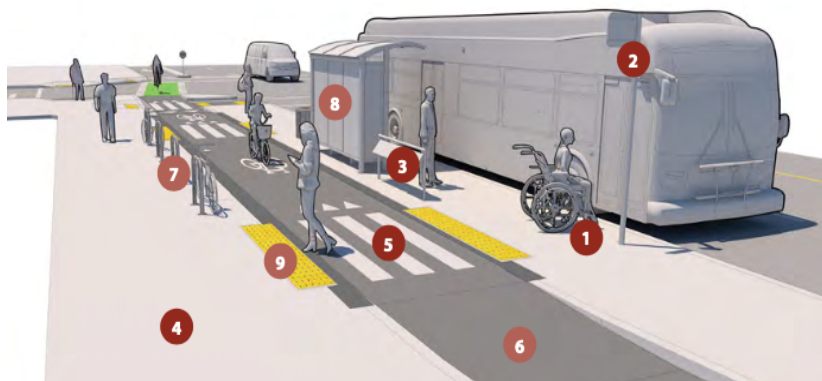

Figure 11: Transit Stop Elements taken from BCATG Figure H-136



Our transit stops located on either side of the Eagles Dr intersection will incorporate the design elements identified in section H1 - Multi-Modal Integration of the BCATG. These include a 3.0m wide landing pad that can accommodate bus shelters, two pedestrian-cyclist zebra crosswalks on each side for pedestrians to access the stop by crossing the protected bike lane.

#### 4.4 Pick-up Drop-off

The objective of implementing a pick-up and drop-off zone along the East Mall corridor is to improve traffic flow and road user safety, through several design iterations this has been accomplished in our design. Drawing C-3 shows the proposed design for the 155-meter pick-up drop-off section from Stadium Rd to Eagle Dr. A designated pick-up and drop-off lane design provides optimal traffic flow as well as pedestrian, bicyclist and motorist safety. Separation of fast-moving traffic along East Mall from the slow-moving traffic where motorists are looking to temporarily park to pick-up and drop-off passengers allows for steady traffic movement during peak sporting facility demands. The design proposes a 1m median between the main driving lane along East Mall and the drop-off lane to provide a buffer between fast- and slow-moving traffic. In addition, a 1.7m buffer is provided between the parking lane and the cyclist lane. This buffer provides adequate room for pedestrians to enter and exit parked vehicles and avoid conflicts with cyclist lane traffic. Marked crosswalks will be provided for pedestrians crossing over the bike lane to further enhance safety and reduce the risk of pedestrian and cyclist collisions. Additional signage is provided alerting the cyclists to slow down passing through this area and to be aware of crossing pedestrians.

#### 4.5 Canopy

The purpose of the canopy on Agronomy Road is to provide weather protection for pedestrians and is designed to maximize use. While investigating the area, it was noted that the canopies in the building's vicinity are simple and mainly constructed of translucent panels with a metal

frame; therefore, the canopy design possesses a similar appearance. Aluminum is used for the canopy framing, which is lightweight, non-corrosive, and less expensive compared to alternatives such as steel and iron. The elastic nature of the aluminum beams improve the flexibility of the structure under earthquake loads, and the durability of the material increases the lifespan and minimizes the need for regular maintenance. Additionally, the design incorporates translucent polycarbonate panels to allow for light penetration into the building, which maintains building occupant comfort. Polycarbonate panels can be cut to size and are lightweight, strong, and can withstand extreme temperatures. The design of the canopy aims to improve user comfort by shielding pedestrians from wind driven rain and user safety is maximized by the robust structural design. See section 5.0 for further discussion on the service-life and life cycle analysis of the canopy materials.

## 4.6 Geotechnical Considerations

For this project it is important to understand the surface geology in order to design efficient water management solutions and subsequent construction planning. No building foundations are required for the scope of this project, underground utilities and lamp post foundations (up to 1.2m depth) are of primary concern. Thus, the top 3 metres of soil will be evaluated.

### 4.6.1 Desktop Study

At the current state of the design, a site-specific geotechnical investigation has not been completed. A desktop study was undertaken on several geotechnical reports found for on-campus building projects. The most recent and closest to the project site was by EXP in December 2019 for the MacLeod building renewal on Main Mall. Four borehole logs were published and across the site the soil profile was fairly consistent across the first few metres. The first 0.3m consisted of asphalt, fill or sandy topsoil. Below this depth the soil was described as primarily sand, some silt to silty, some gravel, grey, damp to moist (dense to very dense, Till-

like). Further down, it became siltier with trace to some gravel found and damp at about 3.0m depth. This mixed soil, especially near the ground surface, could be expected as the surrounding area of the site is highly developed. The native deeper soils are representative of till material which was also highlighted by the Vancouver Soils Map and Geomap Vancouver alike

#### 4.6.2 Site Conditions

Due to the varied soil conditions and the developed nature of the site, a generalized classification is given to the site as silty clay loam. For water control calculations this results in a design infiltration rate of 1.5mm/hour, as per standard USDA literature values as found in the Appendix F.

As this project is upgrading existing development, we have confidence in the stability of the soils. Compaction has already taken place at the base level of the roadworks and, to our knowledge, has performed well with consistent use. Construction planning with the selected contractor will layout compaction details to ensure the new fill is placed appropriately.

Consideration has been given to the upper aquifer that exists approximately 70 metres below East Mall which has led to concerns for the slope stability and erosion at the exposed cliff faces north of campus. Written into the UBC Integrated Stormwater Management Plan are limitations on infiltration within 300 metres of the cliffs. However, our site is well beyond that limitation and as such infiltration through the native soils is allowed.

Earthquakes are of general concern in the Lower Mainland, however the risk of liquefaction is generally low at the site, based on Geomap Vancouver information [1]. Earthquake resilient design for the transportation infrastructure is outside the scope of this project and due to the low-risk soil stabilization methods will not be discussed in detail.

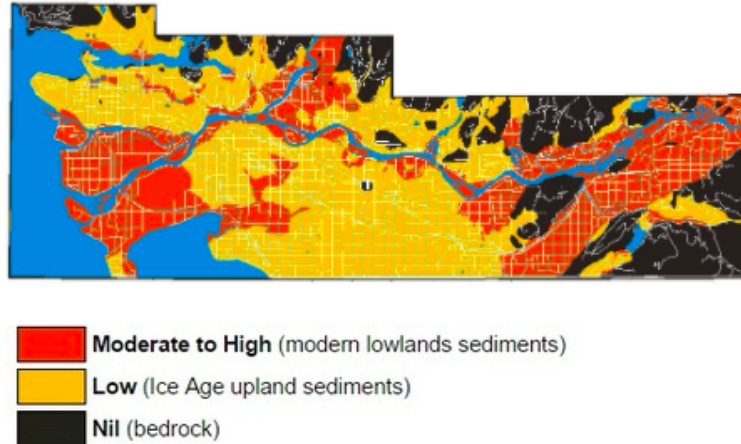

*This map provides only a generalized interpretation of liquefaction susceptibility during an earthquake and should not be used for local geotechnical evaluation.*

*Figure 12: Earthquake Liquefaction Susceptibility, Geomap Vancouver, 1998*

## 4.7 Water Management

The bioswale and rain garden capacities and demands were calculated using the Simplified Rainfall Capture Method. The decision of how much water to retain was guided using the UBC Integrated Stormwater Management Plan, where it states new infrastructure must be able to retain a 10-year, 24-hour event and convert the outflow to a 2-year, 24-hour predevelopment rate [2]. Metro Vancouver [3] states the typical capture target of source controls to be 72% of the 2-year, 24-hour storm. Using 2100 IDF curves from the City of Vancouver [4], a rainfall intensity of 5.5 and 4.0 mm/hr is shown for the 10-year and 2-year return, 24-hour duration, respectively. Since the Metro Vancouver guideline exceeds the UBC guideline, the governing capture target is 72% of the 4mm/hr over a 24-hour duration. Calculations showing the following results can be found in Appendix E.

To meet the source control storage requirement, As outlined above in section 4.6, An infiltration rate of 1.5 mm/hr has been determined for the expected soils on site. This further increases the volume of water our systems can handle as water will be constantly infiltrating back into the ground, helping also to recharge the local water table. We have removed curbs from around the

bioswales within the central medians and added overflow drains, protruding up to 0.3m above the base of bioswales. This allows runoff to enter the bioswale from anywhere, eliminating concerns of localized erosion, or clogging/jamming of curb cuts preventing runoff from entering. The inclusion of the storm overflow drains allows ponding to occur, increasing retention capacity, while preventing flooding back into the street.

## 4.8 Sustainability Considerations

From the initial project phases, through to the final detailed design, sustainability has always been a high priority. When it comes to road design, achieving a sustainable design requires being able to achieve all of the underlying project objectives and to minimize environmental impact due to construction. We have planned for a phased construction, scheduled in such a way that aims to expedite the construction timeline while also reducing the overall impact to the area (road closure, traffic diversions, etc.). Next, in an effort to align with UBC's active transportation goals, as well as meet one of the overall project objectives, we have prioritized sustainable modes of transportation (walking, biking, transit) by improving the overall safety for these road users. Not only will this encourage alternate methods of transportation to help minimize environmental impacts, it will help improve the health of locals in the area, while also reducing vehicle traffic, further increasing safety. Next, with the addition of our pick-up/drop-off zone, and road design to tie into the planned future Thunderbird neighborhoods, we are ensuring the longevity of our design as the surrounding areas will not out-grow it. Our construction methodology aims to minimize demolition and excavation wherever possible to minimize construction time, cost, environmental impacts, and material usage. All required construction materials have been locally sourced, all materials that can be recycled will be, and plans have been established to efficiently deal with all materials that must be removed from site. Finally, by means of the on-site stormwater management plan we have integrated into our design by taking advantage of all green space, it is clear that the project's net environmental

impacts are further reduced. Stormwater will be dealt with on site by being directed into one of the engineered bioswales or rain gardens where the water will be naturally filtered before being allowed to infiltrate, recharging the local water table, or directed into the existing UBC storm water system. These rain gardens and bioswales will be populated with native plant species, lending to the aesthetics of the project and improving local air quality. A great feature of bioswales and rain gardens is that provided the plants are taken care of for the first 1-3 years, they require minimal to no maintenance for the remainder of their existence; another aspect helping to ensure the design's longevity.

## 5.0 Service-life Maintenance Plan and LCA

The materials and systems selected were driven by the desire to reduce the carbon emissions and increase the service-life of the design. It is important to plan for service-life and develop effective maintenance plans to ensure the design components achieve maximum performance within the required lifespan and within an acceptable range of maintenance costs. To quantify the environmental information on the life cycle of a product, Environmental Product Declarations (EPDs) were used to assess the environmental impacts of the main construction materials. Life cycle assessments are typically done in three project stages, which will be considered in the cradle-to-gate analysis of the materials incorporated in the design: raw material supply (A1), transport (A2), and manufacturing (A3). The maintenance plan and LCA will focus on three key components: the canopy structure, the road and sidewalks, and the water management system.

### 5.1 Canopy

Aluminum is the primary construction material for the canopy structure. It is a sustainable material with a desirable strength-to-weight ratio and can be recycled multiple times without compromising its properties. The Environmental Product Declaration (EPD) for hot-rolled aluminum provided by The Aluminum Association [11] states that “the North American

aluminum industry has reduced the carbon footprint of primary aluminum production by 37 percent since 1995.” Aluminum is corrosion resistant and does not require frequent replacement, which makes it a low-maintenance building material with a service life of 30-40 years. The aluminum EPD claims that the recycling rate for aluminum products in construction market sectors is greater than 95%. The EPD also provides results on the cradle-to-gate and end-of-life environmental performance of a metric ton of hot-rolled aluminum, which concludes that the majority of the environmental impacts are from aluminum production. However, the recycling benefits of aluminum at the end-of-life offset the initial negative impacts.

The polycarbonate panels used for the canopy decking have an expected service life of 15 to 20 years. After this period, the panels may need to be replaced to maintain the durability and appearance of the product. Additionally, the canopy must be cleaned regularly to prevent the buildup of algae and moss on the surface. The stainless-steel fasteners have a service life of 65 to 100 years, and the sealant must be replaced every 5 to 10 years to prevent water leakage. The expected service life of the aluminum gutter downpipe is 20 to 40 years. The service-life of the canopy components are summarized in Table 7 below.

*Table 7: Service Life of Canopy Components*

<b>Component</b>	<b>Service-life (years)</b>
Aluminum Beams	30 - 40
Stainless Steel Fasteners	65 - 100
Polycarbonate Panels	15 - 20
Sealant	5 - 10
Aluminum Gutter Downpipe	20 - 40

## 5.2 Road and Sidewalks

As mentioned in Section 3.6, asphalt will be used for repaving the roadway and bike lanes, and concrete will be required for the curb lines and pedestrian sidewalks. Carbon emissions for the concrete components were calculated based on a value of 304.52 kg of CO<sub>2</sub>e per cubic meter obtained from the EPD by CRMCA (Canadian Ready-Mixed Concrete Association) [12]. The combined embodied carbon of the concrete sidewalks and curb lines is ~210 Tons of CO<sub>2</sub> with a service life of 50-100 years. The Carbon Footprint Estimation in Road Construction Case Study [13] states that the carbon footprint for asphalt is 65.8 kg of CO<sub>2</sub>e per lane-km, which results in a total of ~138 Tons of CO<sub>2</sub>e with an expected service life of 15-20 years with regular maintenance. It is assumed that the asphalt will be sourced from Lafarge, a provider of sustainable construction materials. Lafarge typically uses up to 30% of reclaimed asphalt, which reduces life-cycle greenhouse gases by 10%. The pavement maintenance program will include pothole repair, crack filling, sealcoating, and other surface treatments to preserve the integrity and appearance of the road. Regular sweeping and line painting will also be performed when necessary. Additionally, sidewalks and curbs will be inspected annually to assess the condition of the concrete for repair or replacement. Wedges, patches, and crack repairs may be required to reduce trip hazards and maintain sidewalk safety, and seasonal maintenance is necessary for vegetation control as well as snow and ice removal.

## 5.3 Water Management System

General landscaping is required twice a year, in the spring and summer months, to sustain a safe and clean environment while maintaining the performance of the water management system. Landscape services will be performed as required and may include lawn mowing, fertilization and pest control, spring mulching, insect treatment, leaf removal, and trimming. Any litter or debris must be removed from the grass before mowing and grass edges will be trimmed to the sidewalks and around the base of planting areas. All plants will be watered as necessary



to promote healthy plant growth, and the use of herbicides for weed control is not recommended.

## 6.0 Construction Work Plan

East Mall is a well-used North-South collector road and acts as a key access to the multiple sports fields. As such, construction planning must be given adequate consideration to avoid extensive road closures and to minimize the impact to road users. Hence, a construction work plan has been developed as a part of the detailed design to ensure the project is delivered on time and on budget. This section outlines the sequencing, requirements, and issues related to the construction phases of the East Mall Redevelopment project.

### 6.1 Construction Schedule

The construction of the project will begin on May 15, 2021 and the road will be commissioned on August 27, 2021. The timeline of construction will take advantage of the low traffic on campus due to COVID-19, as well as the warm weather in the spring and summer months. The segment of East Mall between Agronomy and Stadium Road will be closed to the public for the duration of construction to accelerate the process, which will ultimately reduce costs. Prior to commencing construction, the required environmental assessments and construction permits were attained. Next, the traffic management plan was implemented to ensure the safety of pedestrians, cyclists, vehicles users, and the workers on-site. Following the pre-construction phase, the excavation of the roadway and boulevard is set to begin. During the excavation, the removal of trees and existing infrastructure such as asphalt, curbing, and sidewalks will take place followed by any underground utility relocations that are required due to conflicts. Once the project site has been stripped, the new road base materials can be laid. Concurrently, the construction of the bioswales and rain gardens can begin to satisfy the stormwater management plan. Next, the pouring of the concrete curb and gutter as well as the sidewalks can begin. Once

complete, final grading of the site can take place followed by paving crews. Finishing touches such as line painting, landscaping and installation of the pedestrian canopy will close out the final phases of construction prior to the recommissioning of the roadway. The proposed schedule is also subject to changes due to uncertainties in conditions and efficiencies; therefore, the construction process may be extended or expedited depending on the flexibility of the project and the owner's request. A detailed outline of the construction schedule can be found in Appendix A.

## 6.2 Requirements

There are a number of requirements for the construction phase of the East Mall redevelopment project. The first major requirement for construction to take place is to receive approval on environmental, construction, and road closure permits. Any problems or deficiencies that occur on receiving city approvals could result in extensive delays to the project completion date.

Additionally, large quantities of materials will be required to be transported to site. Therefore, effective staging areas and routing of haul trucks are necessary to minimize traffic delays. As such, trucks and transfers will be staged along East Mall between 16th Ave and Stadium Road and their entrance and exit to and from site will be controlled by flaggers. Maintaining a high level of safety for construction workers is a critical requirement. Hence, a full-time first aid station and accompanying attendant will be required anytime work is being conducted.

Additionally, all persons wishing to enter the active construction site must first perform a site orientation. This site orientation will educate workers on the safety risks that are present on this particular site.

## 6.3 Issues

There are often a number of issues that come up during the construction phases of a project. This is largely due to assumptions that are made during the design phases of the project.

Therefore, unforeseen issues are presented and must be dealt with effectively and in a timely manner to reduce project delays. A potential issue during construction is encountering periods of variable weather. The majority of roadwork is weather dependent, therefore workdays could be lost due to periods of summer rain leading to delays in the project completion. An additional issue that could be faced during construction is conflicts with existing buried utilities. Very limited records have been supplied to provide information on the existing utilities that are located within the project boundaries. As a result, a contingency for utility conflicts has been accounted for and all conflicts and resulting relocations in excess of this contingency will be performed at an additional cost to the final cost presented in Section 7.

## 7.0 Cost Estimate

A table providing a full cost breakdown is included in Appendix B. Our price was determined by first determining the quantities of different materials that will be removed from site, as well as new materials required. Materials were recycled whenever possible to reduce overall cost. The areas used for determining the volume of different materials were measured using google earth and compared with our scaled AutoCAD drawings. Factored within the unit rate for all pay items in our cost estimate are material costs, installation/placement costs, and trucking fees. We have allowed for a very conservative annual maintenance fee for the project, accounting for extensive landscaping in the area to maintain the aesthetic beauty of the area, as well as to immediately address any asphalt or sidewalk issues, should they arise. A cost breakdown for the primary project phases is present below in Table 8.

Table 8: Cost Breakdown by Project Phase

Project Phase	Description	Total Cost
Phase 0	Permitting	\$ 15,000.00
Phase 1	Site Preparation	\$ 23,500.00
Phase 2	Construction	\$ 2,202,655.00
Phase 3	Project Completion	\$ 7,000.00
Phase 4	Recurring Costs	\$ 12,500.00
SUB TOTAL		\$ 2,245,655.00
GST		\$ 112,282.75
CONTINGENCY (18%)		\$ 404,217.90
TOTAL COST		\$ 2,762,155.65

## 8.0 Conclusion

Our design meets all objectives through integrated stormwater management, improved active transportation infrastructure, a safe separated pickup/drop-off bay, and weather protection at the Agronomy Intersection. The redesign of this segment of East Mall is in line with campus policy for improving sustainable transportation options at UBC by creating a corridor for all modes of transportation, with a priority on walking, cycling, and transit. Our project minimizes construction costs by expediting construction during the reduced traffic demands as a result of COVID-19. Total project costs are estimated at **\$2.76 million**, with an estimated **completion date of August 27th, 2021**.

## 9.0 References

- [1] Geomap Vancouver, 1998. Vancouver: Earthquake Liquefaction. Available: <https://www.cgenarchive.org/vancouver-geomap.html>
- [2] UBC Vancouver Campus Integrated Stormwater Management Plan, 2017. Vancouver, BC: University of British Columbia Campus + Community Planning. Available: [https://planning.ubc.ca/sites/default/files/2019-11/PLAN\\_UBC\\_ISMP\\_Final2017.pdf](https://planning.ubc.ca/sites/default/files/2019-11/PLAN_UBC_ISMP_Final2017.pdf)
- [3] Stormwater Source Control Design Guidelines, 2012. Vancouver, BC: MetroVancouver, Kerr Wood Leidal Associates Ltd., Goya Ngan. Available: <http://www.metrovancouver.org/services/liquid-waste/LiquidWastePublications/StormwaterSourceControlDesignGuidelines2012StormwaterSourceControlDesignGuidelines2012.pdf>
- [4] Regional IDF Curves, Metro Vancouver Climate Stations: Phase, 2009. Burnaby, BC: BGC Engineering Inc. Available: [https://bylaws.vancouver.ca/bulletin/bulletin-rainwater-management.pdf?fbclid=IwAR02tjWfvUaEFmJ4vfw7VWRI8dBDowZjK6OD1-LX4fvMt\\_5a2dP3YOO50wQ](https://bylaws.vancouver.ca/bulletin/bulletin-rainwater-management.pdf?fbclid=IwAR02tjWfvUaEFmJ4vfw7VWRI8dBDowZjK6OD1-LX4fvMt_5a2dP3YOO50wQ)
- [5] National building code of Canada, 2015th ed. Ottawa, Ont.: National Research x Council Canada, Institute for Research in Construction, 2015.
- [6] British Columbia building code, 2018. Victoria, BC: Province of British Columbia/National Research Council, 2018.
- [7] BC Active Transportation Design Guide, 2019th ed. Ministry of Transportation and Infrastructure, 2019
- [8] Trip Generation Manual, 10th Edition – Volume 1. Washington, DC: Institute of Transportation Engineers, 2020
- [9] City of Vancouver Engineering Design Manual, 2019 - City of Vancouver
- [10] City of Vancouver Standard Detail Drawings, 2018 - City of Vancouver
- [11] Environmental Product Declaration Hot-Rolled Aluminum, 2014. The Aluminum Association.
- [12] CRMCA Member Industry-Wide EPD for Canadian Ready-Mixed Concrete, 2017. Mississauga, Ontario: Canadian Ready Mixed Concrete Association.
- [13] Carbon Footprint Estimation in Road Construction: La Abundancia-Forencia Case Study, 2019. Espinoza et. al. DOI: 10.3390/su11082276

## Appendix A - Schedule

East Mall Redevelopment Construction Schedule

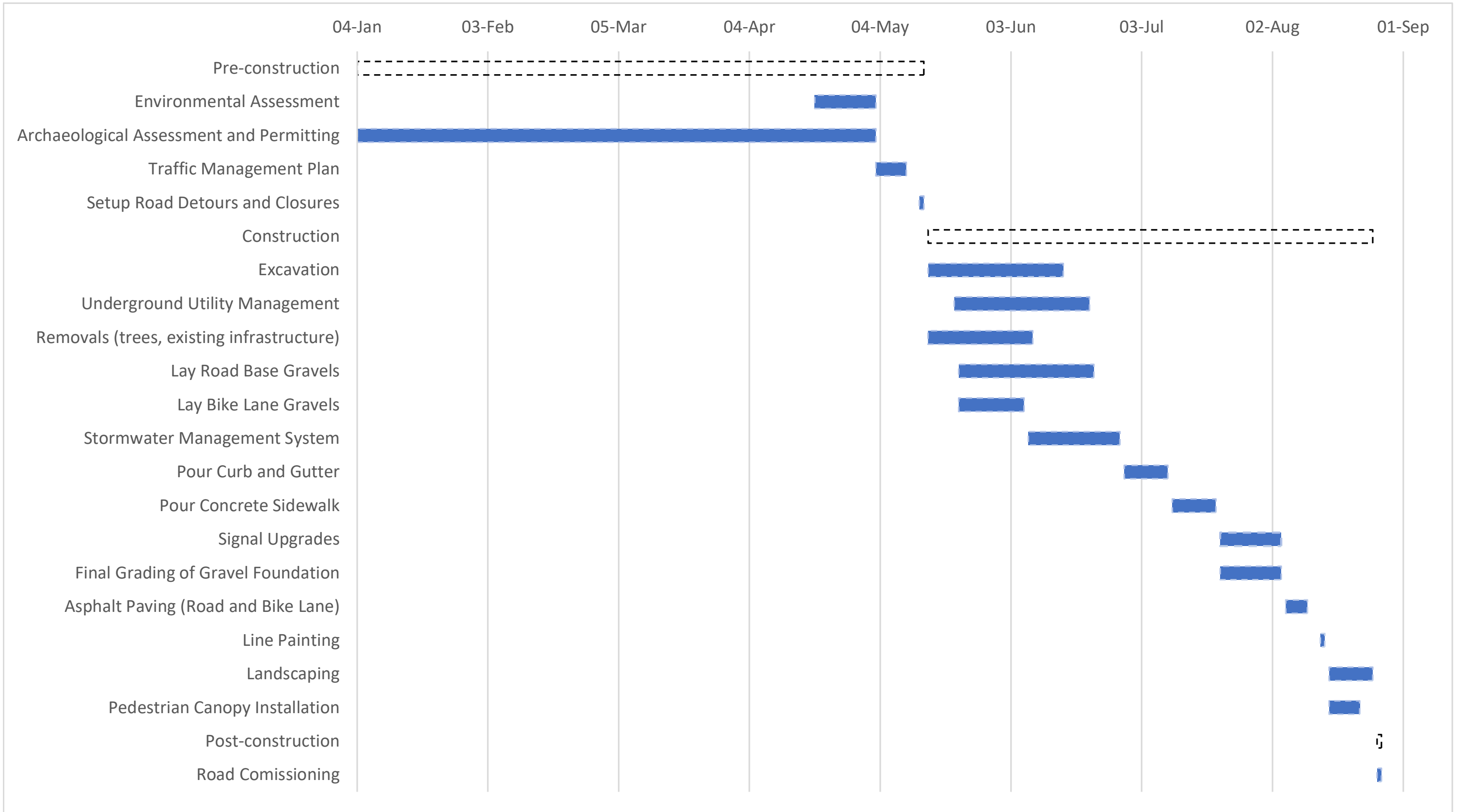

## Appendix B - Cost Estimate



**Appendix B - Class C Cost Estimate**  
**SCHEDULE OF EFFORT (2020/21)**  
**Preliminary Design Services**

ACTIVITY	QUANTITY	UNIT	UNIT RATE	TOTAL COST
<b>Phase 0: Permitting</b>	-	-	-	\$ 15,000.00
<b>Phase 1: Site Preparation</b>	-	-	-	\$ 23,500.00
Task 1.1: Traffic Set-up	1	LS	\$ 15,000.00	\$ 15,000
Task 1.2: Construction Fencing	1000	LM	\$ 5.00	\$ 5,000
Task 1.3: Site-Office Set-Up	1	LS	\$ 2,500.00	\$ 2,500
Task 1.4: Utility Mark-ups	1	LS	\$ 1,000.00	\$ 1,000
<b>Phase 2: Construction</b>				\$ 2,202,655
Task 2.1: Asphalt Removal (140mm)	7500	m <sup>2</sup>	\$ 8.00	\$ 60,000
Task 2.2: Curb and Gutter Removal	1800	LM	\$ 20.00	\$ 36,000
Task 2.3: Sidewalk Removal	2800	m <sup>2</sup>	\$ 30.00	\$ 84,000
Task 2.4: Excavation	6155	m <sup>3</sup>	\$ 35.00	\$ 215,425
Task 2.5: Material Placement and Compaction (Incl. Material, Trucking, Regrading Costs)	10662	m <sup>3</sup>	\$ 45.00	\$ 479,790
Task 2.6: Asphalt Paving (140mm)	9000	m <sup>2</sup>	\$ 40.00	\$ 360,000
Task 2.7: Curb and Gutter	2000	LM	\$ 20.00	\$ 40,000
Task 2.8: Sidewalks	2800	m <sup>2</sup>	\$ 80.00	\$ 224,000
Task 2.9: Stormwater Management - Rain Gardens	762	LM	\$ 350.00	\$ 266,700
Task 2.10: Stormwater Management - Bioswales	465	LM	\$ 650.00	\$ 302,250
Task 2.11: Landscaping	1483	m <sup>2</sup>	\$ 30.00	\$ 44,490
Task 2.12: Structural Canopy	1	LS	\$ 30,000.00	\$ 30,000
Task 2.13: Intall Traffic Control Systems (Linepainting, Crosswalks, Streetlights, etc.)	1	LS	\$ 50,000.00	\$ 50,000
Task 2.14: Site Clean-up	1	LS	\$ 10,000.00	\$ 10,000
<b>Phase 3: Project Completion</b>				\$ 7,000.00
Task 3.1: Project Sign-off	1	LS	\$ 5,000.00	\$ 5,000
Task 3.2: Project Hand-off	1	LS	\$ 2,000.00	\$ 2,000
<b>Phase 4: Recurring Cost (Annually)</b>				\$ 12,500
Task 4.1: Maintenance	-	-	\$ 2,500.00	\$ 2,500
Task 4.2: Landscaping	-	-	\$ 10,000.00	\$ 10,000
			<b>SUB TOTAL</b>	<b>\$ 2,245,655</b>
			<b>GST</b>	<b>\$ 112,283</b>
			<b>CONTINGENCY (18%)</b>	<b>\$ 404,218</b>
			<b>TOTAL COST</b>	<b>\$ 2,762,156</b>

## Appendix C - Structural Design Calculations

seismic loads on canopies are typically very small since they are lightweight and not subject to significant forces. Assumed that the building will absorb forces imposed by earthquakes.



Creative Thinking  
Practical Results

Project CIVL 446 - Canopy Design Loads

Date RJC No.

Designer Jade Lissel

Snow loads (NBCC Section 4.1.6.2)

$$S = I_s [S_s (C_b C_w C_s C_a) + S_r]$$

→  $I_s = 1.0$  (ULS, normal importance)

→  $S_s = 1.9$  (BCBC Section 1.1.3, Table C-2 Vancouver, Granville + 41 Ave) → more conservative than City Hall

→  $C_b = 0.8$  for  $l_c \leq \left(\frac{70}{C_w^2}\right)$

$$l_c = 2w - w^2/l = 2(2.5) - 2.5^2/7.2 = 4.1m \leq 70 \checkmark$$

∴  $C_b = 0.8$

→  $C_w = 1.0$

→  $C_s = 1.0$  (slope < 30°)

→  $C_a = C_{a0} - (C_{a0} - 1)(x/x_d)$  for  $0 \leq x \leq x_d$  or  $C_a = 1.0$  for  $x > x_d$

$$C_{a0} = \min \left\{ \begin{array}{l} \beta \frac{\gamma h}{C_b S_s} = 1 \frac{(3)(1.5)}{(0.8)(1.9)} = 2.96 \\ \frac{F}{C_b} = 1.35/0.8 = 1.68 \end{array} \right.$$

$$\gamma = \min \left\{ \begin{array}{l} 4 \\ 0.43 S_s + 2.2 = 3.0 \end{array} \right.$$

↳ assume  $h \approx 25m$

$$F = 0.35 \beta \sqrt{\frac{8(l_c s - 5h p^0)}{S_s}} + C_b = 0.35(1) \sqrt{\frac{3(4.1 - 5(0.5))}{1.9}} + 0.8 = 1.35$$

$$l_c s = 2w s - \frac{w s^2}{l_s} = 4.1m$$

$$h p^0 = \frac{1}{3} \left( \frac{0.8 S_s}{\gamma} \right) = \frac{0.8(1.9)}{3} = 0.51$$

$$x_d = 5 \frac{C_b S_s}{\gamma} (C_{a0} - 1) = 5 \frac{(0.8)(1.9)}{3} (1.68 - 1) = 1.72$$

$$x = 10h' = 10 \left( h - \frac{C_b C_w S_s}{\gamma} \right) = 10 \left( 1.5 - \frac{0.8(1)(1.9)}{3} \right) = 9.97 \approx 9.9m$$

∴  $C_a = 1.0$

→  $S_r = 0.3$  (BCBC Section 1.1.3, Table C-2 Vancouver, Granville + 41 Ave)

$$S = 1.0 [1.9 (0.8 \times 1 \times 1 \times 1) + 0.3] = 1.82 KPa$$

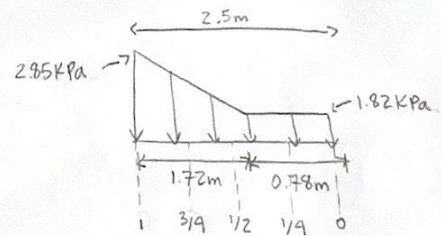
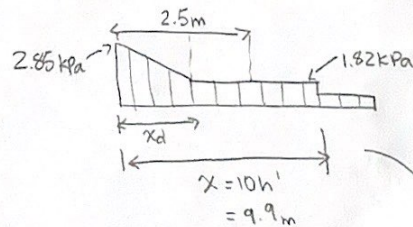
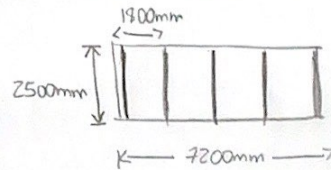

$$w_{3/4} (0.625m) = 2.48 KPa$$

$$w_{1/2} (1.25m) = 2.09 KPa$$

$$w_{1/4} (0.625m) = 1.82 KPa$$

End beams: 2.23, 1.88, 1.64 kN/m

Int. beams: 4.46, 3.76, 3.28 kN/m

→  $w_{x=0} : C_a = C_{a0} = 1.68 \rightarrow S = 2.85 KPa \times 1.8m = 5.13 KPa$

$w_{x_d < x < 10h'} : C_a = 1.0 \rightarrow S = 1.82 KPa$



\* estimate building height = ~10m

Wind loads (NBCC Section 4.1.7.3)

External pressure / suction:  $p = I w q C_e C_t C_g C_p$

→  $I_w = 1.0$  (ULS, normal importance)

→  $q = 0.45 \text{ kPa}$  (BCBC Section 1.1.3, Table C-2, 150 for Vancouver, Granite + 41 Ave)

→  $C_e = \left(\frac{h}{10}\right)^{0.2}$  → assume open terrain (worst case)

↳  $h$  is mid-height of canopy above ground →  $h = \frac{2.7}{2} = 1.35 \text{ m}$

$C_e = 0.81$

→  $C_t = 1.0$

→  $C_p, C_g$  → NBCC Figure 4.1.7.6-C

Trib. area =  $1.8 \times 2.5 = 4.5 \text{ m}^2$

↳  $C_p C_g = 0.4, -2.5$  (edge beams)

$C_p C_g = 0.4, -1.8$  (interior beams)

upper surface pressure

edge beams

lower surface pressure (uplift)

$P_1 = 1(0.45)(0.81)(1)(0.4) = 0.15 \text{ kPa}$

$P_2 = 1(0.45)(0.81)(1)(-2.5) = -0.91 \text{ kPa}$

interior beams  $\left\{ \begin{array}{l} P_1 = 1(0.45)(0.81)(1)(0.4) = 0.15 \text{ kPa} \\ P_2 = 1(0.45)(0.81)(1)(-1.8) = -0.66 \text{ kPa} \end{array} \right.$

\* only account for downwards wind b/c parent wall is relatively tall

Trib. width edge beams =  $\frac{1.8}{2} = 0.9 \text{ m}$

Trib. width interior beams =  $1.8 \text{ m}$

Wind load edge beams =  $0.15 \times 0.9 = 0.14 \text{ kN/m}$   
 " " interior " =  $0.15 \times 1.8 = 0.27 \text{ kN/m}$   
 " " edge beams =  $-0.82 \text{ kN/m}$   
 " " interior " =  $-1.64 \text{ kN/m}$

Dead load

aluminum unit weight =  $27 \text{ kN/m}^3$

polycarbonate unit weight =  $11.77 \text{ kN/m}^3$

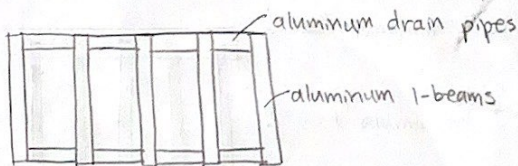

$27 \frac{\text{KN}}{\text{m}^3} \times 0.2 \text{ m} \times 0.2 \text{ m} = 1.08 \text{ kN/m}$  (aluminum)

$11.77 \frac{\text{KN}}{\text{m}^3} \times 2.5 \text{ m} \times 0.016 \text{ m} = 0.47 \text{ kN/m}$  (poly)

Total =  $(1.08 \times 5 + 0.06 \times 2 + 0.47 \times 1) 1.15$   
 =  $6.9 \text{ kN/m}$

Aluminum drain beam:

→  $6 \times 4 \times 0.125$  beam

↳  $4.03 \text{ lbs/ft} = 0.06 \text{ kN/m}$

\* add ~15% additional weight for plates, fasteners, etc.



\* Used Handbook of steel Construction (11th Edition) as a reference

Check shear connection of W200x46 I-beam and L89x89x6.4

→ 2-24mm diameter A325 bolts

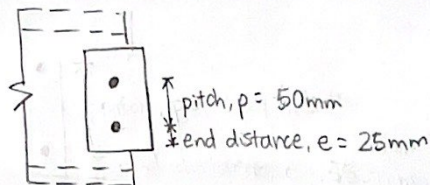

↳ note that this is only a sample calculation of one of the connections in the canopy design

→ 6061 aluminum beam, 2.5m long:  $F_y = 276 \text{ MPa}$ ,  $F_u = 310 \text{ MPa}$

→ grade 300W steel angles on either side of the beam webs, fastened to the wall of the building

Shear capacity per bolt:

$$V_r = 0.6 \phi_b n A_b F_{ub} \times 0.75 = 0.6 (0.8) (1) (2) (452.4 \text{ mm}^2) (825 \text{ MPa}) = 358.3 \text{ kN/bolt}$$

→  $\phi_b = 0.8$

↳ assume threads included in shear planes

→  $n = \# \text{ bolts} = 1$

→  $m = \# \text{ shear planes} = 2$

→  $A_b = \text{nominal bolt area} = \frac{\pi}{4} d^2 = \frac{\pi}{4} (24)^2 = 452.4 \text{ mm}^2$

→  $F_{ub} = \text{tensile strength of bolt} = 825 \text{ MPa (for A325, if bolt } \phi < 1'')$

Bearing capacity per bolt:

$$B_r = 3 \phi_{br} t d n F_u = 3 (0.8) (7.2) (24) (1) (310) = 128.6 \text{ kN/bolt}$$

→  $\phi_{br} = 0.8$

→  $t = \text{thickness of beam web} = 7.2 \text{ mm}$

→  $d = \text{bolt diameter} = 24 \text{ mm}$

→  $n = \# \text{ bolts} = 1$

→  $F_u = \text{tensile strength} = 310 \text{ MPa}$

Shear demand:

$$V_f = \frac{4 M_r}{L} = \frac{4 (\phi Z_x F_y)}{L} = \frac{4 (0.9) (495 \times 10^3 \text{ mm}^3) (276)}{2500} = 196.7 \text{ kN}$$

$$\# \text{ of bolts required} = \frac{V_f}{B_r} = \frac{196.7}{128.6} = 1.53 = \sim \underline{\underline{2 \text{ bolts required}}}$$



\* the bolts in double shear carry double the load of those in single shear  $\therefore$  only one check is required

\* the beam web thickness is less than twice the angle thickness ( $w_b < 2t_a$ )  
 $\therefore$  the beam web is critical for bearing

Shear capacity of angles:

$$V_r = \phi_u \left[ 0.6 A_{gv} \left( \frac{F_y + F_u}{2} \right) \right]$$

$$\rightarrow A_{gv} = \text{total length of angle} \times \text{thickness} = (np + ze)t_a = (2(50) + 2(25))(6.35) = 952.5 \text{ mm}^2$$

$$\rightarrow F_y = 300 \text{ MPa}, F_u = 450 \text{ MPa (steel angle)}$$

$$\rightarrow \phi_u = 0.75$$

$$V_r = 0.75 \left[ 0.6 (952.5) \left( \frac{300 + 450}{2} \right) \right] = 160.7 \times 2 \text{ angles} = 321.5 \text{ kN} > V_f = 196.7 \text{ kN} \checkmark$$

Block shear capacity of angle:

$$T_r = \phi_u \left[ U_t A_n F_u + 0.6 A_{gv} \left( \frac{F_y + F_u}{2} \right) \right] = 246$$

$$\rightarrow U_t = 0.6 \text{ for angles connected by one leg}$$

$$\rightarrow A_n = \text{net area in tension} = A_g - \text{bolt area} = (d_L - g - 0.5(d_b))t_a$$

$$\begin{aligned} & \text{* standard gauge} = 65 \text{ mm} \\ & \text{* assume bolts will be punched} \rightarrow d_b = d + A = 2A + 4 \text{ mm} \\ & (d_L - g - 0.5(d_b))t_a = (89 - 65 - 0.5(28))(6.35) = 63.5 \text{ mm}^2 \end{aligned}$$

$$\rightarrow A_{gv} = \text{gross area in shear} = Lt_a = (np + e)t_a$$

$$= (2(50) + 25)(6.35) = 793.75 \text{ mm}^2$$

$$T_r = 0.75 \left[ 0.6 (63.5) (450) (2) + 0.6 (793.8) \left( \frac{300 + 450}{2} \right) (2) \right] = 293.6 \text{ kN}$$

$$= 293.6 \text{ kN} > V_f = 196.7 \text{ kN} \checkmark$$

(for 2 angles)

$$\text{Total length of angles} = p + ze = 50 + 2(25) = 100 < \frac{d}{2} = \frac{203}{2} = 101.5 \checkmark$$

$\therefore$  Use a 100mm long angle with 2-24M A325 bolts on each side of the web for each I-beam in the canopy.

## Appendix D - SAP2000 Analysis

# SAP2000 Canopy Frame Analysis

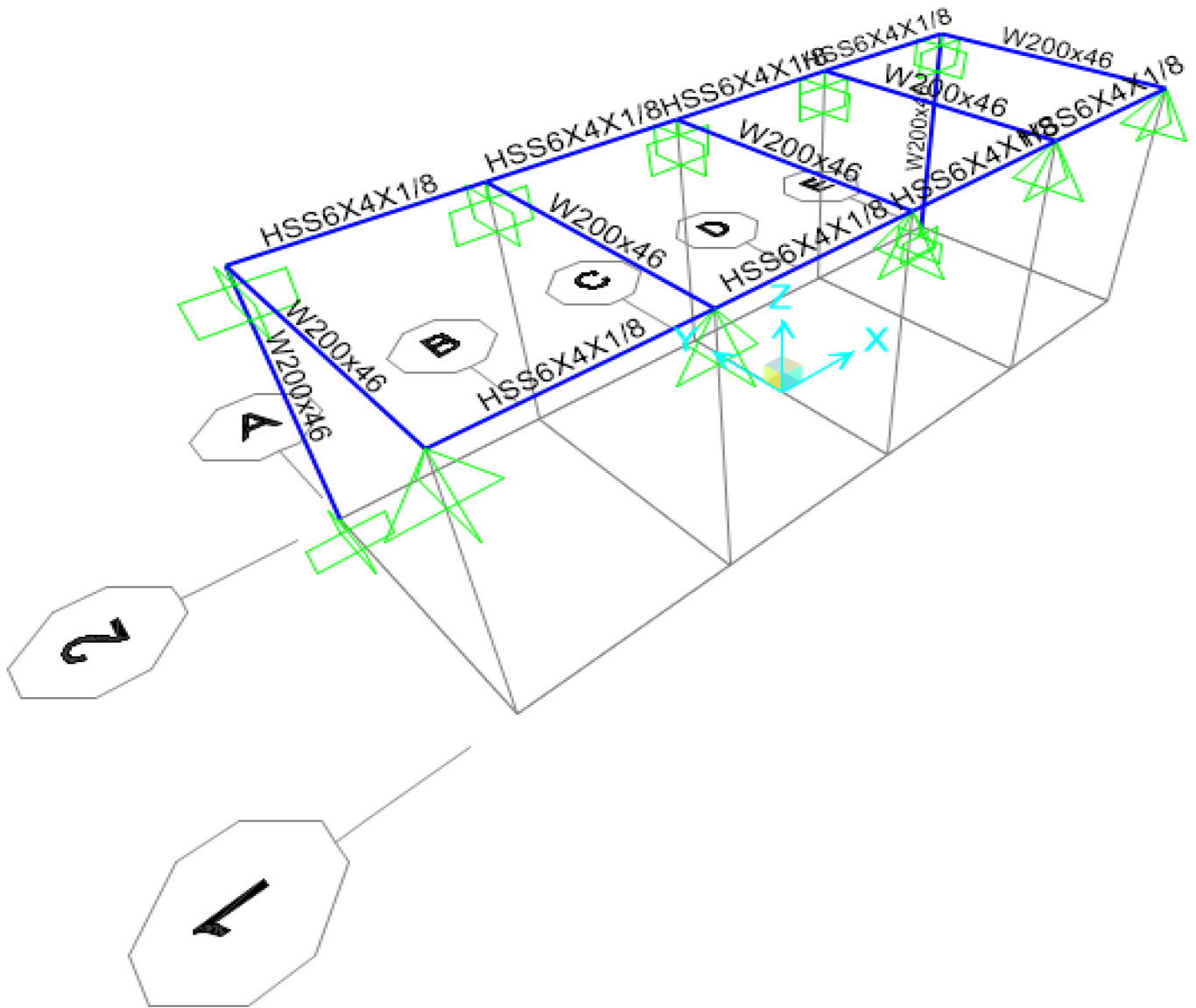

Figure 1: Section Properties





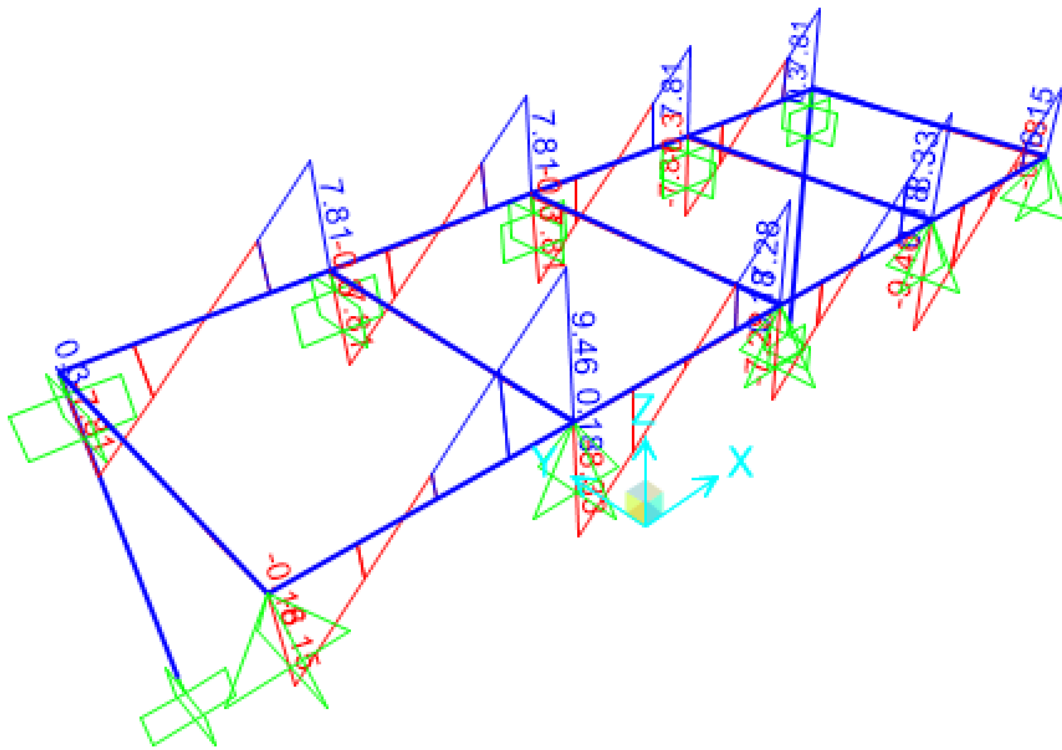

Figure 4: Shear Force Diagram

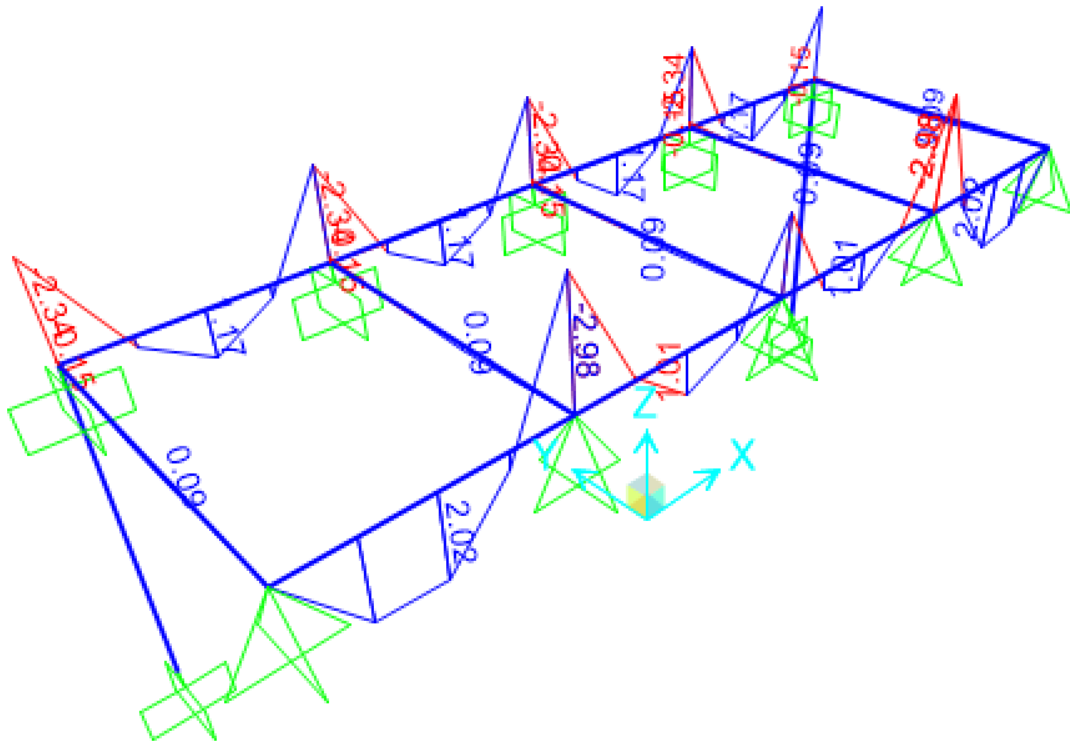

Figure 5: Moment Diagram

## Appendix E - Rain Garden Calculations

**Stormwater Management Storage Calculations**

Initial Parameters	
2year-24hr:	4 mm/hr
72%, 24-hr amount	69 mm/day
*Assume Dry Conditions Prior to storm	
Input Parameters	
Evaporation Loss	1 mm/day
Soil Depth	250 mm
Rockpit Porosity	35% %
Sand Filter Porosity	40% %
Soil Field Capacity	25% %
Soil Wilting Point	5% %
Native Soil infiltration	1.5 mm/hr
9m BioSwale	
Total Road width	13 m
Total Road Length	200 m
Extra Road Area	78 m <sup>2</sup>
<b>Total Input Volume</b>	<b>309.52 m<sup>3</sup></b>
Bioswale width	9 m
Bioswale length	200 m
Bioswale Base width	3 m
Total Evaporation	1.8 m <sup>3</sup>
Growing Med Storage	90 m <sup>3</sup>
Infiltration	64.80 m <sup>3</sup>
Sand Filter Depth	250.00 mm
Sand Filter Storage	60.00 m <sup>3</sup>
Rock pit Depth	500 mm
Total Rock Pit Volume	105 m <sup>3</sup>
<b>Total Storage Volume</b>	<b>321.60 m<sup>3</sup></b>

4m BioSwale	
Total Road width	10 m
Total Road Length	200 m
Extra Road Area	60 m <sup>2</sup>
<b>Total Input Volume</b>	<b>197.68 m<sup>3</sup></b>
Bioswale width	4 m
Bioswale length	145 m
Bioswale base width	3 m
Total Evaporation	0.8 m <sup>3</sup>
Growing Med Storage	40 m <sup>3</sup>
Infiltration	28.80 m <sup>3</sup>
Sand Filter Depth	250.00 mm
Sand Filter Storage	60.00 m <sup>3</sup>
Rock pit Depth	500 mm
Total Rock Pit Volume	76.125 m <sup>3</sup>
<b>Total Storage Volume</b>	<b>205.73 m<sup>3</sup></b>

3.5m BioSwale	
Total impervious width	8.7 m
Total Road Length	80 m
Extra Road Area	70 m <sup>2</sup>
<b>Total Input Volume</b>	<b>72.30 m<sup>3</sup></b>
Bioswale width	3.5 m
Bioswale length	60 m
Bioswale base width	3 m
Total Evaporation	0.21 m <sup>3</sup>
Growing Med Storage	10.5 m <sup>3</sup>
Infiltration	7.56 m <sup>3</sup>
Sand Filter Depth	250.00 mm
Sand Filter Storage	24.00 m <sup>3</sup>
Rock pit Depth	500 mm
Total Rock Pit Volume	31.5 m <sup>3</sup>
<b>Total Storage Volume</b>	<b>73.77 m<sup>3</sup></b>

2m RainGarden	
Total Pavement width	5.5 m
Total Pavement Length	55 m
Extra Impervious Area	60 m <sup>2</sup>
<b>Total Input Volume</b>	<b>32.66 m<sup>3</sup></b>
Raingarden Width	2 m
Raingarden Length	55 m
Overflow Height	100 mm
Total Evaporation	0.11 m <sup>3</sup>
Growing Med Storage	5.5 m <sup>3</sup>
Infiltration	3.96 m <sup>3</sup>
Rock pit Depth	500 mm
Total Rock Pit Volume	19.25 m <sup>3</sup>
Total Ponding Volume	11.00 m <sup>3</sup>
<b>Total Storage Volume</b>	<b>39.82 m<sup>3</sup></b>

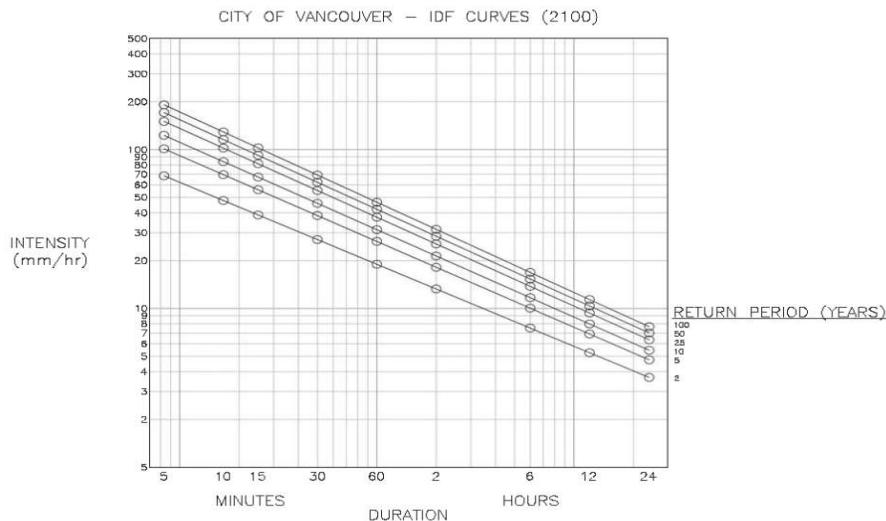

## Sample Calculation: 9m Bioswale (Simplified Rainfall Capture Method)

### Input Parameters

2-year, 24hour Duration =  $4 \frac{mm}{hr}$

72% Capture target over the day,  $I_{2-24} = 0.72 * 4 \frac{mm}{hr} * 24 \frac{hr}{day} = 69 \frac{mm}{day}$

Native Soil Infiltration,  $I_s$ , 1.5 mm/hr

Soil Field Capacity,  $\Theta_{FC} = 25\%$

Soil Wilting Point,  $\Theta_w = 5\%$  \* assuming rain event begins at dry conditions

Sand porosity,  $\Theta_s = 40\%$

Rock Pit porosity,  $\Theta_R = 35\%$

### Dimensions

Soil (growing medium) depth,  $S_G = 250mm$

Sand Filter Depth,  $S_F = 250mm$

Rock Pit Depth,  $R = 500mm$

Total Road width,  $W_{road} = 13m$  ; Total Road length,  $L_{Road} = 200m$  ; Extra road area =  $78m^2$

Total Road area =  $W_{Road} * L_{Road} + Extra = 13m * 200m + 78m^2 = 2678 m^2$

Bioswale width,  $W_{Bio} = 9m$  ; Bioswale Length,  $L_{Bio} = 200m$  ; Bioswale Base width,  $B_{Bio} = 3m$

Total "green" area =  $W_{Bio} * L_{Bio} = 9m * 200m = 1800 m^2$

### Total Input

**Input Volume** = (Total Road area + Total Green area) \*  $I_{2-24} = 4478 m^2 * 0.069 \frac{m}{day} = 309.5 m^3$

### Total Storage

Soil storage =  $[\Theta_{FC} - \Theta_w] * [S_G * W_{Bio} * L_{Bio}] = [0.25 - 0.05] * [0.250m * 9.0m * 200m] = 90 m^3$

Sand filter Storage =  $\Theta_s [S_F * B_{Bio} * L_{Bio}] = 0.40[0.250m * 3.0m * 200m] = 60 m^3$

Rock pit Storage,  $\Theta_R [R * B_{Bio} * L_{Bio}] = 0.35[0.500m * 3.0m * 200m] = 105 m^3$

Total Infiltration =  $[I_s * 24hrs] * [W_{Bio} * L_{Bio}] = \left[1 \frac{mm}{hr} * 24 \frac{hrs}{day}\right] * [9.0m * 200m] = 64.8 m^3$

**Total Storage** =  $90 m^3 + 60 m^3 + 105 m^3 + 64.8 m^3 = 319.8 m^3$

**Total Storage > Input volume therefore sizing is good.**

## Appendix F - Soil Classification

# Soil Classification

**Table 1-4: Typical Literature Infiltration Rates**

USDA Soil Class	Saturated hydraulic conductivity (mm/hr)
Sand	210
Loamy sand	61*
Sandy loam	26*
Loam	13
Silt loam	6.8
Sandy clay loam	4.3
Clay loam	2.3
Silty clay loam	1.5
Sandy clay	1.2
Silty clay	0.9
Clay	0.6

\*These are target soil textures for growing medium Level 2 "Groomed" and Level 3 "Moderate" landscape areas in B.C. Landscape Standard, which represent a good balance between infiltration performance and water retention capabilities.

*USDA Standard Soil Hydraulic Conductivity as presented in the Metro Vancouver Stormwater Source Control Design Guidelines (2012), pg. 1-7*

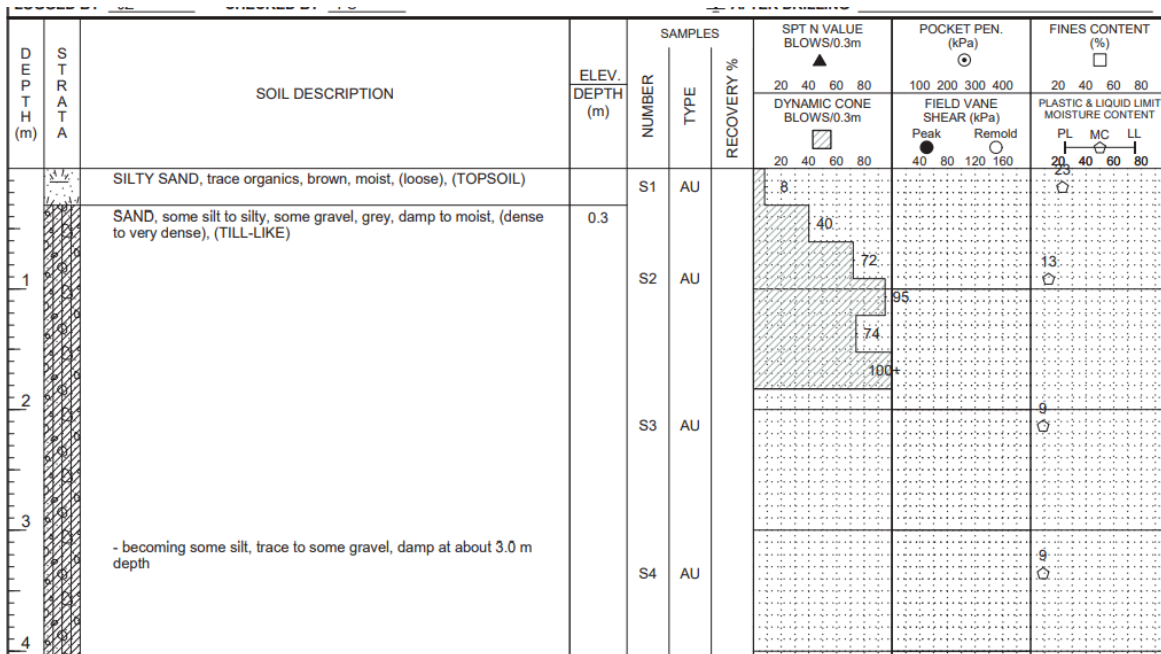

*EXP Borehole Log Sample (2019) for the MacLeod Building on Campus, Reference Data*

## Appendix G - Synchro Report Sample



Lanes, Volumes, Timings  
6: Thunderbird Blvd & East Mall

Future PM  
2020-12-02



Lane Group	EBL	EBT	EBR	WBL	WBT	WBR	NBL	NBT	NBR	SBL	SBT	SBR
Lane Configurations		↕		↖	↗			↕			↕	
Ideal Flow (vphpl)	1900	1900	1900	1900	1900	1900	1900	1900	1900	1900	1900	1900
Storage Length (m)	0.0		0.0	50.0		0.0	0.0		0.0	0.0		0.0
Storage Lanes	0		0	1		0	0		0	0		0
Total Lost Time (s)	4.0	4.0	4.0	4.0	4.0	4.0	4.0	4.0	4.0	4.0	4.0	4.0
Leading Detector (m)	15.0	15.0		15.0	15.0		15.0	15.0		15.0	15.0	
Trailing Detector (m)	0.0	0.0		0.0	0.0		0.0	0.0		0.0	0.0	
Turning Speed (k/h)	25		15	25		15	25		15	25		15
Satd. Flow (prot)	0	1549	0	1770	1759	0	0	1711	0	0	1820	0
Flt Permitted		0.986		0.656				0.876			0.829	
Satd. Flow (perm)	0	1526	0	998	1759	0	0	1499	0	0	1507	0
Right Turn on Red			Yes			Yes			Yes			Yes
Satd. Flow (RTOR)		78			31			60				4
Link Speed (k/h)		50			50			50				50
Link Distance (m)		293.6			319.2			286.4				293.6
Travel Time (s)		21.1			23.0			20.6				21.1
Volume (vph)	8	106	57	272	99	22	43	97	80	147	331	9
Confl. Peds. (#/hr)	70		190	190		70	97		65	65		97
Confl. Bikes (#/hr)			55			17			11			42
Peak Hour Factor	0.75	0.86	0.70	0.83	0.81	0.71	0.77	0.59	0.88	0.93	0.87	0.58
Lane Group Flow (vph)	0	215	0	328	153	0	0	311	0	0	554	0
Turn Type	Perm			Perm			Perm			Perm		
Protected Phases		4			8			2				6
Permitted Phases	4			8			2			6		
Total Split (s)	21.0	21.0	0.0	21.0	21.0	0.0	24.0	24.0	0.0	24.0	24.0	0.0
Act Effct Green (s)		16.3		16.3	16.3			20.7			20.7	
Actuated g/C Ratio		0.36		0.36	0.36			0.46			0.46	
v/c Ratio		0.36		0.91	0.23			0.43			0.79	
Control Delay		8.5		47.8	8.9			9.1			22.7	
Queue Delay		0.0		0.0	0.0			0.0			0.0	
Total Delay		8.5		47.8	8.9			9.1			22.7	
LOS		A		D	A			A			C	
Approach Delay		8.5			35.4			9.1			22.7	
Approach LOS		A			D			A			C	
Queue Length 50th (m)		7.4		23.9	6.4			12.8			36.8	
Queue Length 95th (m)		17.8		#55.6	13.6			14.3			#82.3	
Internal Link Dist (m)		269.6			295.2			262.4			269.6	
Turn Bay Length (m)				50.0								
Base Capacity (vph)		616		371	674			724			697	
Starvation Cap Reductn		0		0	0			0			0	
Spillback Cap Reductn		0		0	0			0			0	
Storage Cap Reductn		0		0	0			0			0	
Reduced v/c Ratio		0.35		0.88	0.23			0.43			0.79	

Intersection Summary

Area Type: Other  
 Cycle Length: 45  
 Actuated Cycle Length: 45  
 Control Type: Semi Act-Uncoord

Maximum v/c Ratio: 0.91

Intersection Signal Delay: 22.0 Intersection LOS: C

Intersection Capacity Utilization 80.3% ICU Level of Service D

Analysis Period (min) 15

# 95th percentile volume exceeds capacity, queue may be longer.

Queue shown is maximum after two cycles.

Splits and Phases: 6: Thunderbird Blvd & East Mall

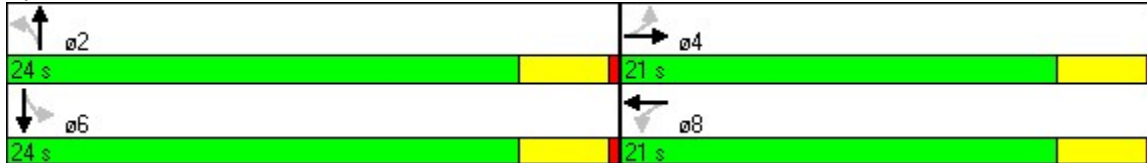

## Appendix H - Technical Drawing Package

GENERAL NOTES:

1. Read all structural/civil drawings in conjunction with all contract documents, including referenced MMCD, electrical, vendor drawings, and specifications
2. The contractor for any portion of work shall visit the site and shall be thoroughly familiar with all the physical features that may affect the work in any way
3. Field measure and make adjustments to suit existing conditions
4. Prior to construction, all sediment control measures shall be in place and retained trees protect as per MMCD standards
5. The contractor shall keep work sites clean and free of all construction debris during the process of construction and leave the site clean upon completion of work or during portions of the work
6. Consultant must approve all deviations from the working drawings. The contractor must keep an accurate record of all changes from the original information shown on the construction drawings.
7. Features of construction not fully shown are of the same character as those noted for similar conditions
8. All construction shall conform to the latest edition of the following: B.C. Occupational Health and Safety Regulation, National Building Code, B.C. Supplement to TAC Geometric Design
9. Foundation bearing soils must be approved by a geotechnical engineer with compaction procedures specified, soil samples to be obtained as requested
10. If discrepancies exist between these drawings and the specifications, contact engineer for review and approval prior to proceeding
11. Do not scale these drawings

LIST OF DRAWINGS:

- P-X : Plan Views
- SN-X: Signage Plans
- C-X: Cross-Section Drawings
- W-X: Stormwater Drawings
- S-X: Structural Drawings
- D-X: Detail Drawings

SPECIFICATIONS FOR REINFORCED CAST-IN-PLACE CONCRETE:

The Work shall consist of:

- Supplying of materials and the mixing and placing of reinforced cast-in-place concrete as shown and described on the Drawings and in this Specification, including placing, vibrating, finishing and curing;
- Supplying, fabricating, constructing, maintaining and removing temporary works, including falsework and formwork;
- Heating and cooling concrete, if necessary;
- Developing concrete mix design(s) that meets the performance requirements, including trial batches;
- The quality control (QC) testing of all materials; and
- Supplying and installing water seals and joint fillers (when applicable). Concrete supplied under this Specification will be specified in accordance with CSA A23.1.
- 1. All concrete plant, equipment, and truck mixers comply with the requirements of CSA A23.1 and this Specification;
- 2. All materials to be used in the concrete comply with the requirements of CSA A23.1 and this Specification;
- 3. All the concrete mix design(s) satisfy the requirements of CSA A23.1 and this Specification;
- 4. Production and delivery of concrete will meet the requirements of CSA A23.1 and this Specification;

CONTRACTOR'S PERFORMANCE CRITERIA:

The submission shall include the Contractor's performance criteria for each mix design including:

- Placeability (i.e. pumping, buggies, truck chute, etc.)
- Workability
- Proposed slump and slump retention time
- Set time

CAST-IN-PLACE CONCRETE MATERIALS:

1. Fine Aggregate Fine aggregate shall meet the grading requirements of CSA A23.1, be graded uniformly and not more than 3% shall pass a 75 um sieve.
2. Coarse Aggregate The maximum nominal size of coarse aggregate shall be 20 mm and meet the grading requirements of CSA A23.1. Coarse aggregate shall be uniformly graded and not more than 1% shall pass a 75 um sieve.
3. Cementitious Materials Cementitious materials shall conform to the requirements of CAN/CSA A23.1 and shall be free from lumps. Normal portland cement, Type GU or GUb, or sulphate resistant, Type HS or HSb, shall be supplied unless otherwise specified on the Drawings.
4. Water Water to be used for mixing and curing concrete or grout and saturating the substrate shall be potable, shall conform to the requirements of CSA A23.1 and shall be free of oil, alkali, acidic, organic materials or deleterious substances.
5. Formwork Forms for exposed surfaces shall be made of good quality plywood in "like-new" condition and uniform in thickness, with or without a form liner.

GENERAL MATERIALS:

1. Deliver materials to job site in dry condition. Keep materials dry and clean until use.
2. All cement to be Portland blast furnace slag cement to CAN-A326 blended hydraulic cements consisting of 75% normal type 10 Portland cement and 25% cementitious hydraulic slag
3. All reinforcing steel to be grade 400 deformed bars to CAN/CSA G30.18
4. Disposal of all excavated material shall be off-site other than approved backfill



East Mall Plan View P2

Unnamed Access

Unnamed Access

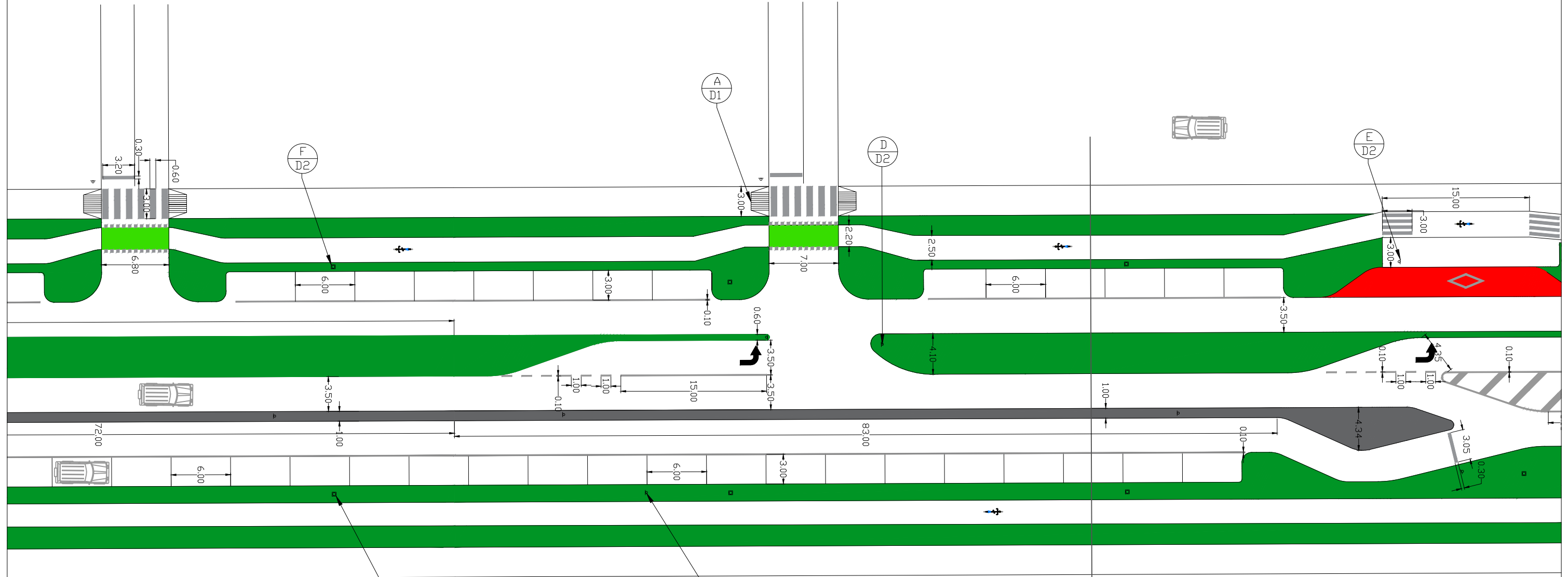

For cross-section design refer to 'Pickup/Dropoff Bay Typical Cross-Section' drawing

ISSUED FOR CONSTRUCTION

03/12/2020	R1
28/02/2021	R2
14/04/2021	R3

TEAM
12
P-2
DETAILED DESIGN
05/04/2021
DRAWN BY: Z.T
REVIEWED BY: A.L
SCALE 1:10

East Mall Plan View P3

Eagles Dr

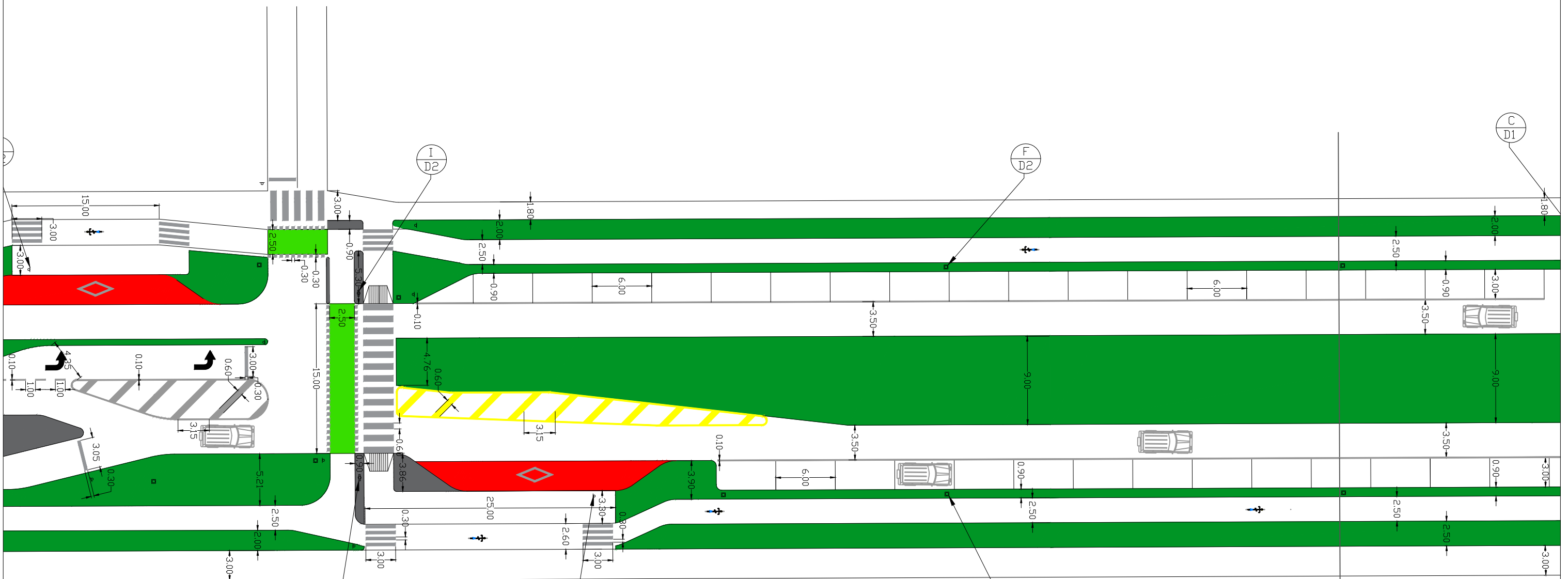

For cross-section design refer to 'South of Thunderbird Blvd Typical Cross-Section' drawing

ISSUED FOR CONSTRUCTION

03/12/2020	R1
28/02/2021	R2
14/04/2021	R3

TEAM
12
P-3
DETAILED DESIGN
05/04/2021
DRAWN BY: A.L
REVIEWED BY: Z.T
SCALE 1:10

East Mall Plan View P4

03/12/2020	R1
28/02/2021	R2
14/04/2021	R3

Logan Ln

Thunderbird Blvd

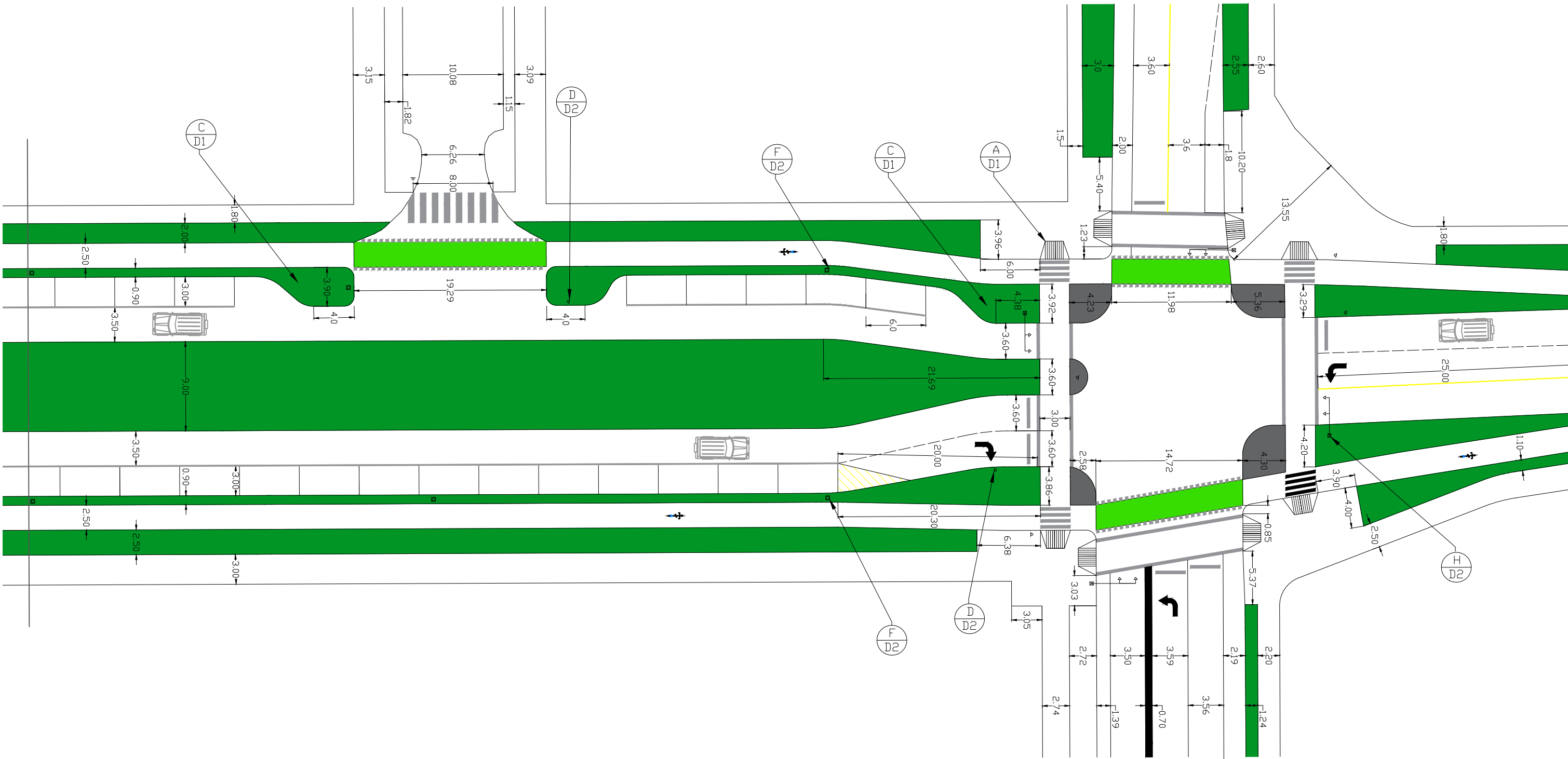

ISSUED FOR CONSTRUCTION

TEAM  
12

P-4  
DETAILED  
DESIGN  
05/04/2021  
DRAWN BY: A.L.  
REVIEWED  
BY: Z.T.

SCALE  
1:10









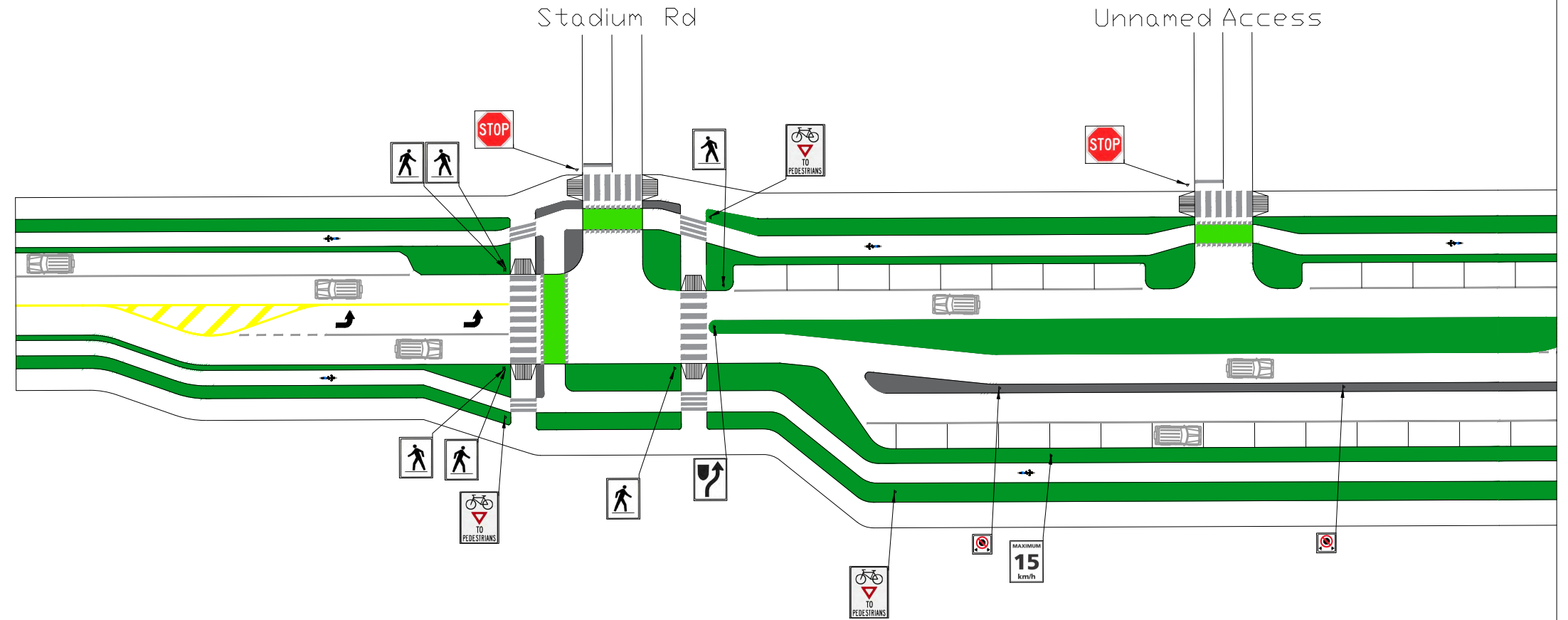

East Mall Plan View (Signs) SN1

03/12/2020	R1
28/02/2021	R2
14/04/2021	R3



- |   |   |   |  |   |   |   |
|---|---|---|--|---|---|---|
|  |  |  |  |  |  |  |
| RA-1<br>X2  | RB-39<br>X3   | R-014-R<br>X1   | P-8D<br>X2   | RA-4L<br>X3   | RA-4R<br>X3   | PS-001<br>X1  |





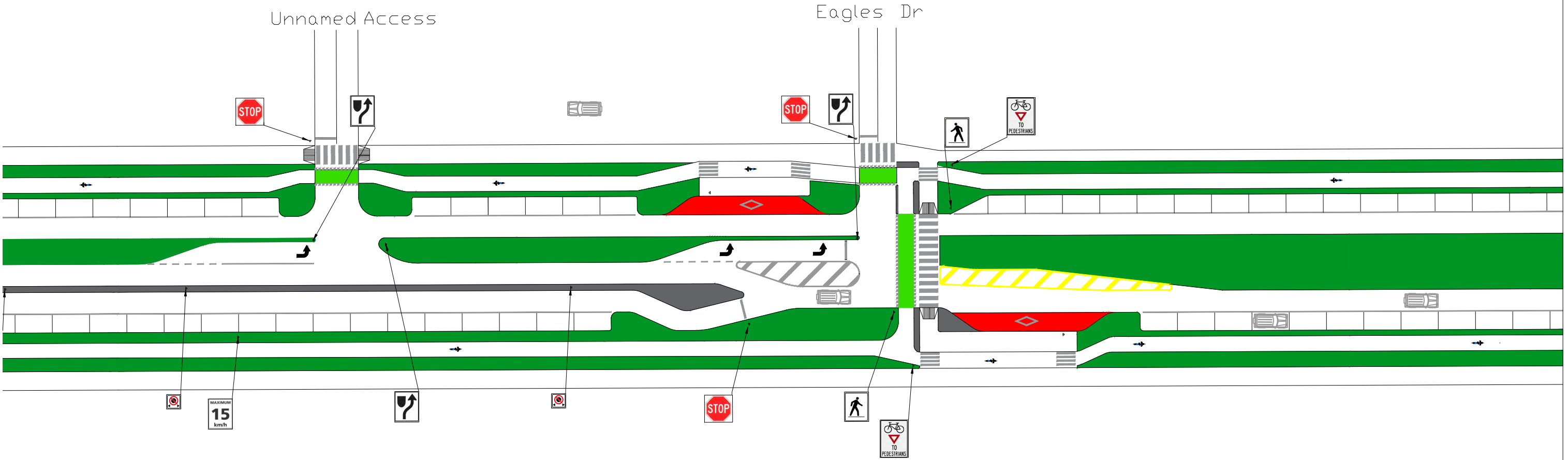

ISSUED FOR CONSTRUCTION

TEAM  
12  
SN-1  
DETAILED DESIGN  
05/04/2021  
DRAWN BY: Z.T  
REVIEWED BY: A.L  
SCALE 1:16

# East Mall Plan View (Signs) SN2

03/12/2020 R1  
28/02/2021 R2  
14/04/2021 R3



- |   |  |   |   |   |   |   |
|---|--|---|---|---|---|---|
|  |  |  |  |  |  |  |
| RA-1<br>X3  | RB-39<br>X2  | R-014-R<br>X3   | P-8D<br>X2  | RA-4L<br>X1   | RA-4R<br>X1   | PS-001<br>X1  |

TEAM  
12

SN-2  
DETAILED  
DESIGN

05/04/2021  
DRAWN BY: Z.T

REVIEWED  
BY: A.L





SCALE  
1:16

ISSUED FOR CONSTRUCTION

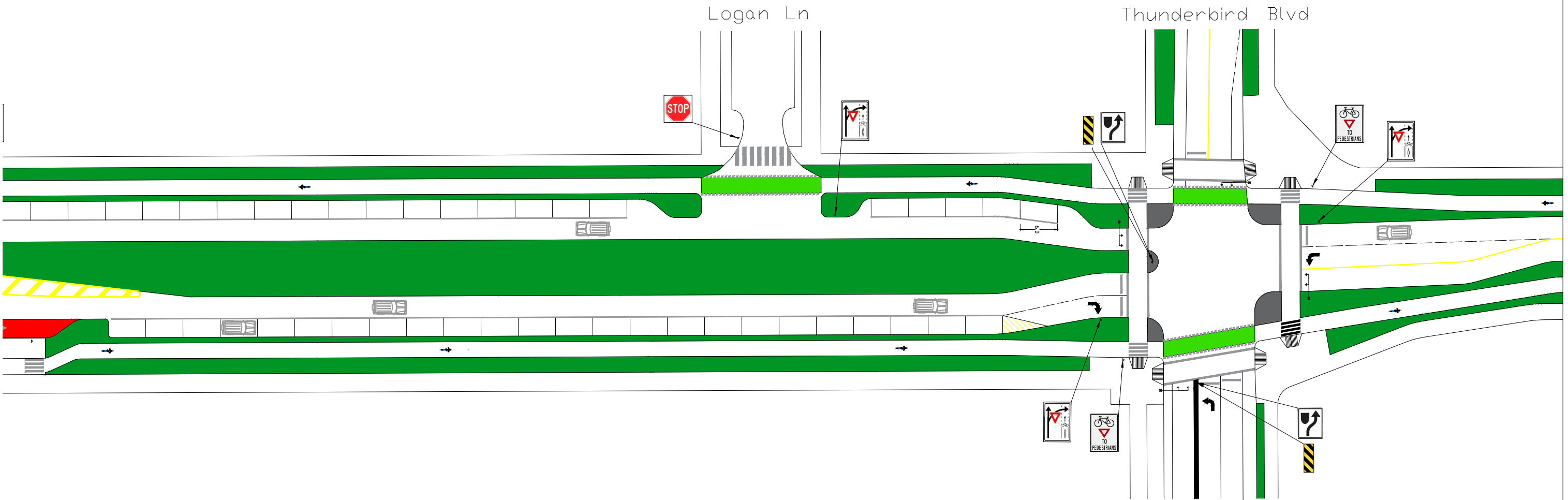
East Mall Plan View (Signs) SN3

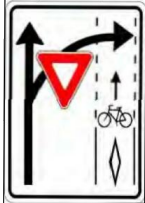
03/12/2020	R1
28/02/2021	R2
14/04/2021	R3



- |   |   |   |   |   |
|---|---|---|---|---|
|  |  |  |  |  |
| RA-1<br>X1  | RB-37<br>X2   | RB-39<br>X2   | R-014-R<br>X2   | W-54L<br>X2   |

ISSUED FOR CONSTRUCTION

TEAM  
12  
SN-3  
DETAILED  
DESIGN  
05/04/2021  
DRAWN BY: Z.T  
REVIEWED  
BY: A.L  
SCALE  
1:16

East Mall Plan View (Signs) SN4

03/12/2020	R1
28/02/2021	R2
14/04/2021	R3

TEAM  
12

SN-4

DETAILED  
DESIGN







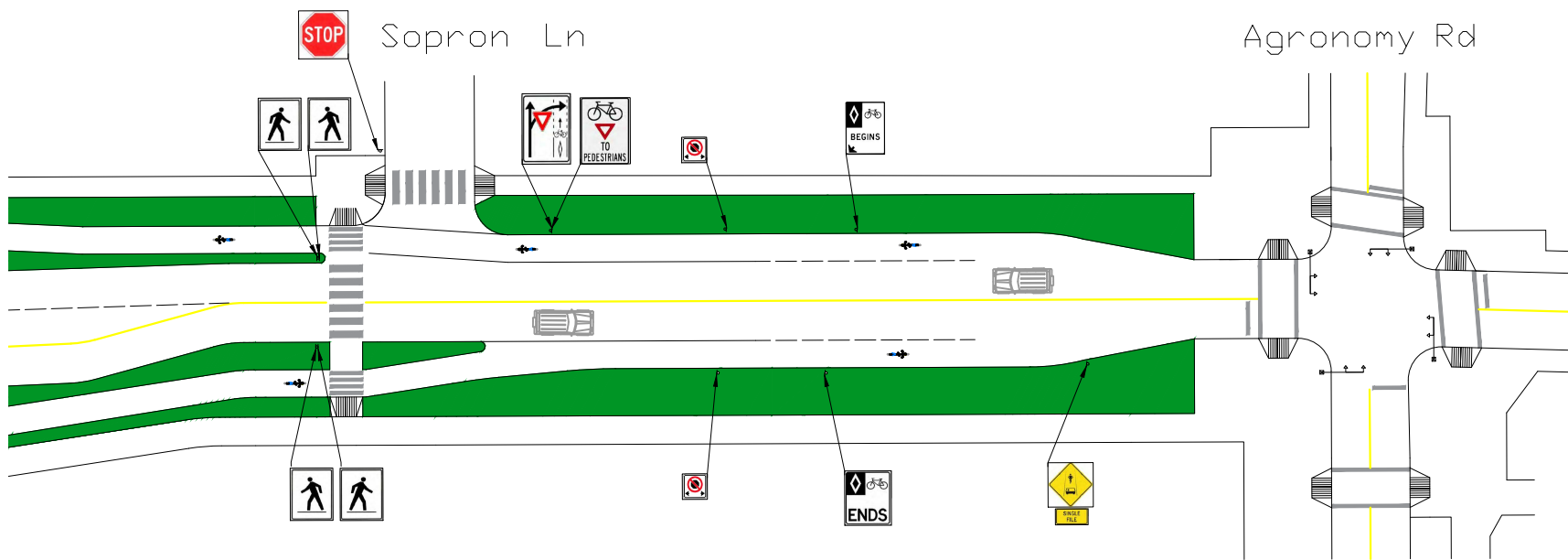

05/04/2021

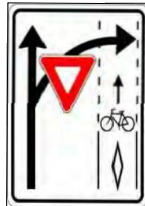
DRAWN BY: Z.T

REVIEWED  
BY: A.L

SCALE  
1:16



- |   |   |   |   |   |   |   |   |   |
|---|---|---|---|---|---|---|---|---|
|  |  |  |  |  |  |  |  |  |
| RA-1<br>X1  | RB-37<br>X1   | RB-39<br>X1   | RA-4L<br>X2   | RA-4R<br>X2   | RB-92<br>X1   | RB-82<br>X1   | P-8D<br>X2  | WC-20<br>X1   |

ISSUED FOR CONSTRUCTION

30/11/2020	R1
26/02/2021	R2
10/04/2021	R3

### C-1: South of Agronomy Road Typical Cross-Section

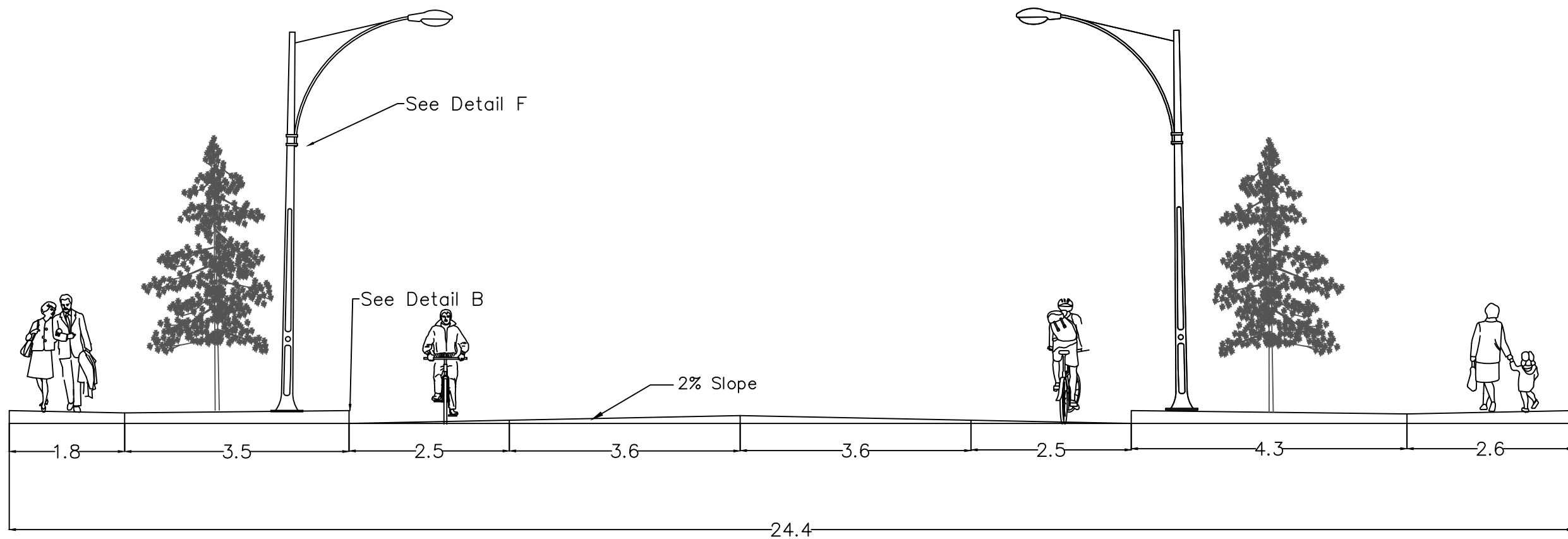

TEAM  
12

C-1  
DETAILED  
DESIGN

10/04/2021  
DRAWN BY: N.W.

REVIEWED  
BY: J.S

1:75

ISSUED FOR CONSTRUCTION

30/11/2020	R1
26/02/2021	R2
10/04/2021	R3

### C-2: South of Thunderbird Blvd Typical Cross-Section

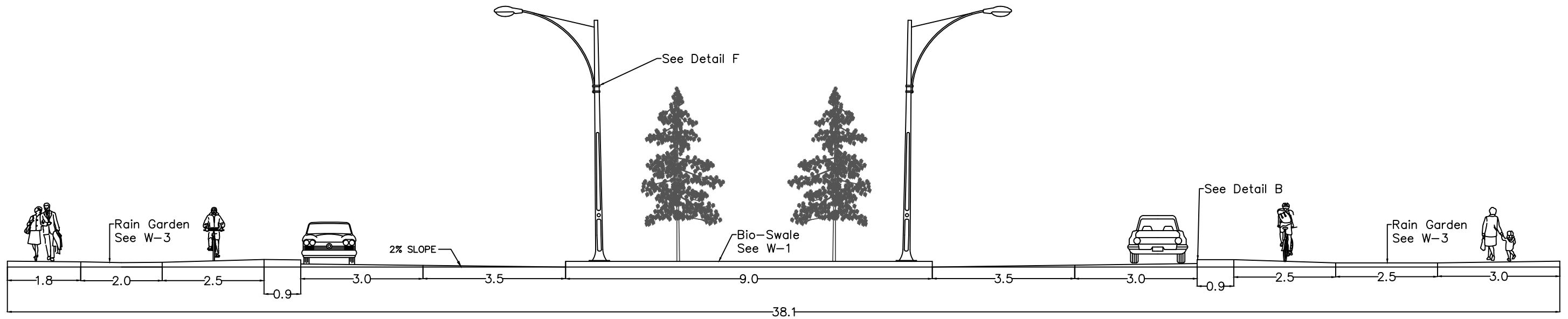

TEAM  
12

C-2

DETAILED  
DESIGN

10/04/2021

DRAWN BY: N.W.

REVIEWED  
BY: J.S

1:100

ISSUED FOR CONSTRUCTION

30/11/2020	R1
26/02/2021	R2
10/04/2021	R3

### C-3: Pickup/Drop-off Bay Typical Cross-Section

PRODUCED BY AN AUTODESK STUDENT VERSION

PRODUCED BY AN AUTODESK STUDENT VERSION

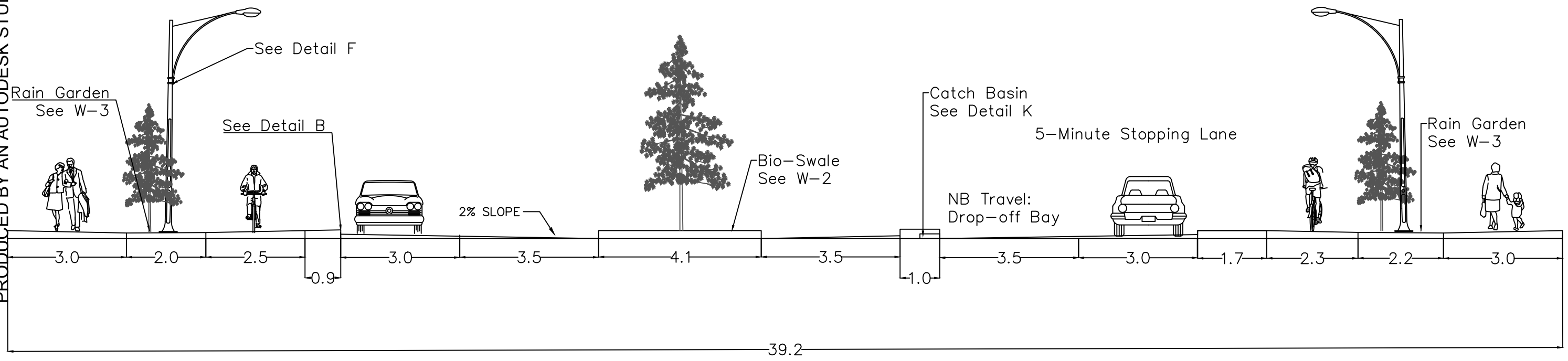

TEAM 12

C-3

DETAILED DESIGN

10/04/2021

DRAWN BY: N.W.

REVIEWED BY: J.S

1:75

ISSUED FOR CONSTRUCTION



### C-4: South of Stadium Rd. Typical Cross-Section

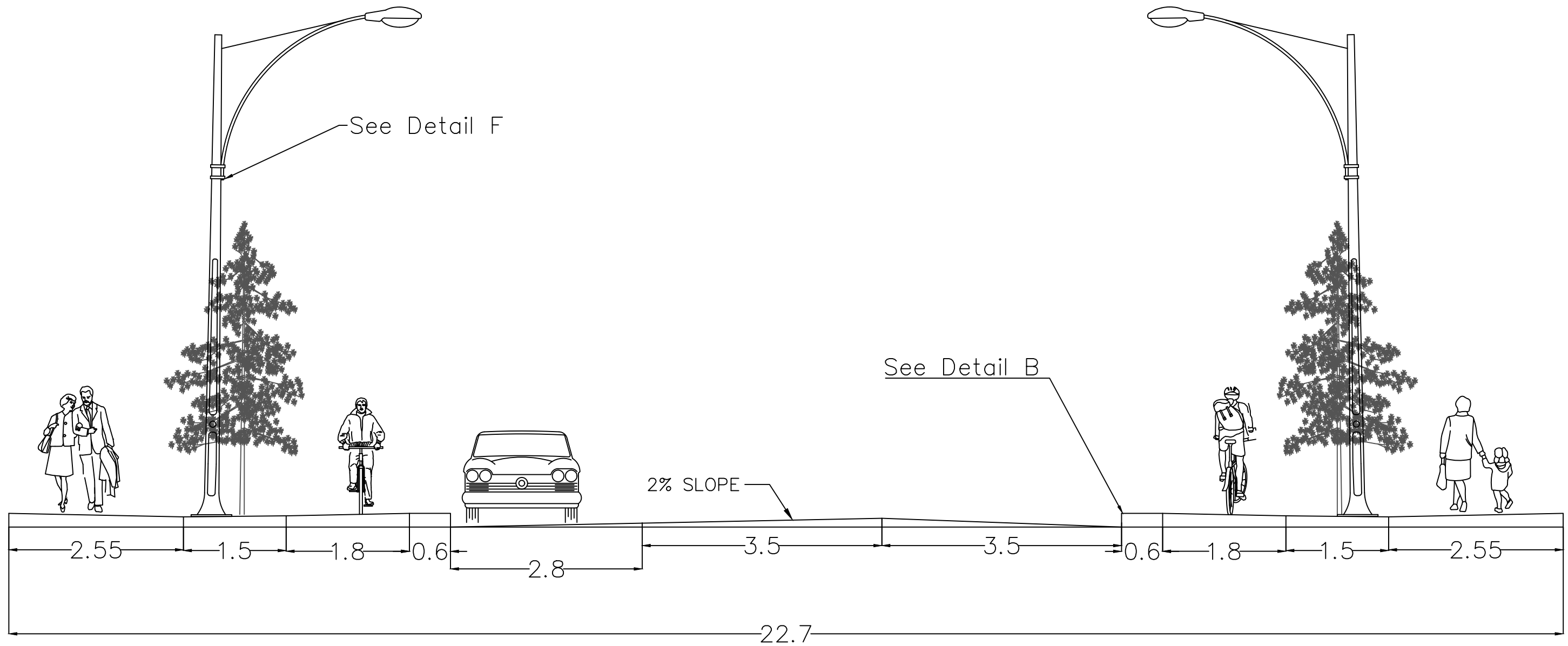

30/11/2020	R1
26/02/2021	R2
10/04/2021	R3

PRODUCED BY AN AUTODESK STUDENT VERSION

TEAM  
12

C-4

DETAILED  
DESIGN

10/04/2021

DRAWN BY: N.W.

REVIEWED  
BY: J.S

1:50

ISSUED FOR CONSTRUCTION

PRODUCED BY AN AUTODESK STUDENT VERSION

# C-5: Standard Road Base Cross-Section

30/11/2020	R1
26/02/2021	R2
10/04/2021	R3

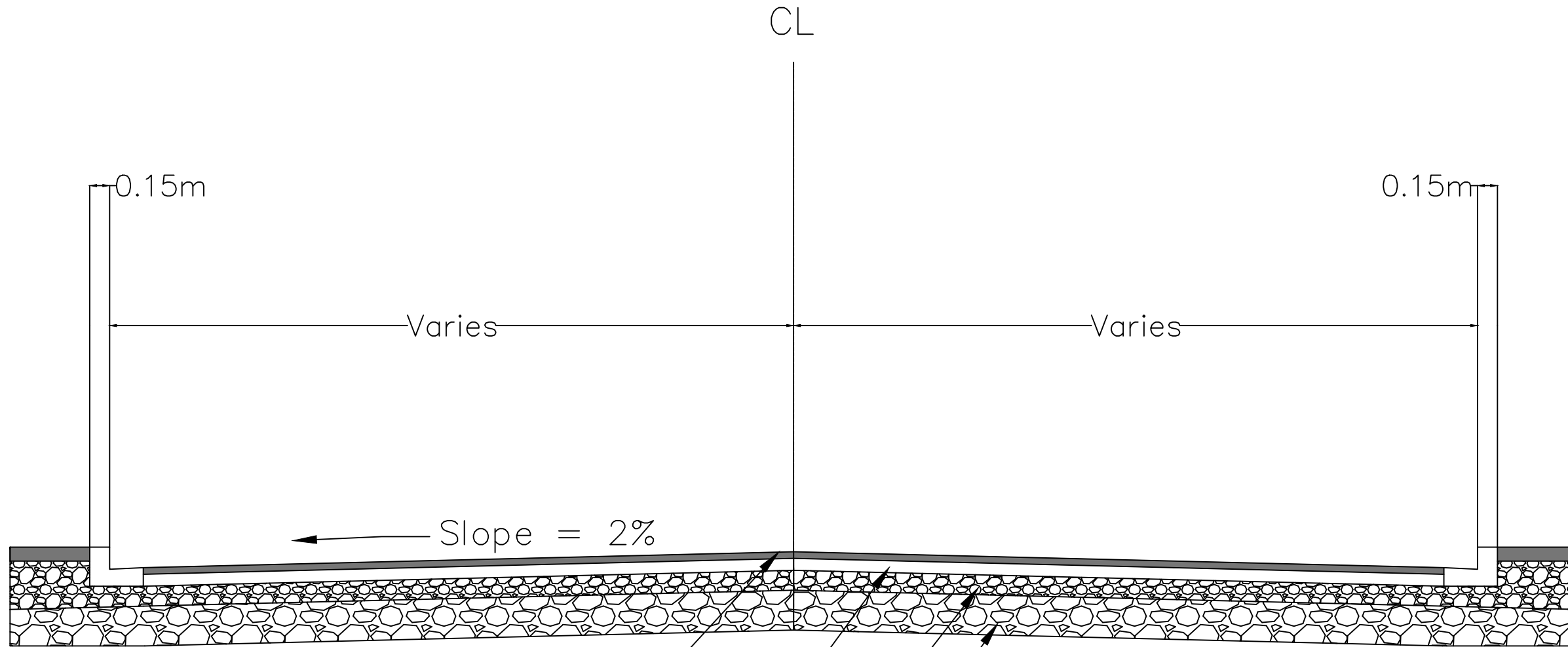

Asphalt Surface Mix – MIN 50mm

Asphalt Base Mix – MIN 90mm

20mm Minus Crushed Granular Base – MIN 150mm

75mm Minus Crushed Granular Subbase – MIN 300mm

Note: Road base is min 0.59m depth, minimum utility cover for gaslines and electrical conduits is 0.6m depth.

ISSUED FOR CONSTRUCTION

TEAM 12

C-5

DETAILED DESIGN

10/04/2021

DRAWN BY: N.W.

REVIEWED BY: J.S.

N.T.S.

02/12/2020	R1
28/02/2021	R2
05/04/2021	R3
13/04/2021	R4

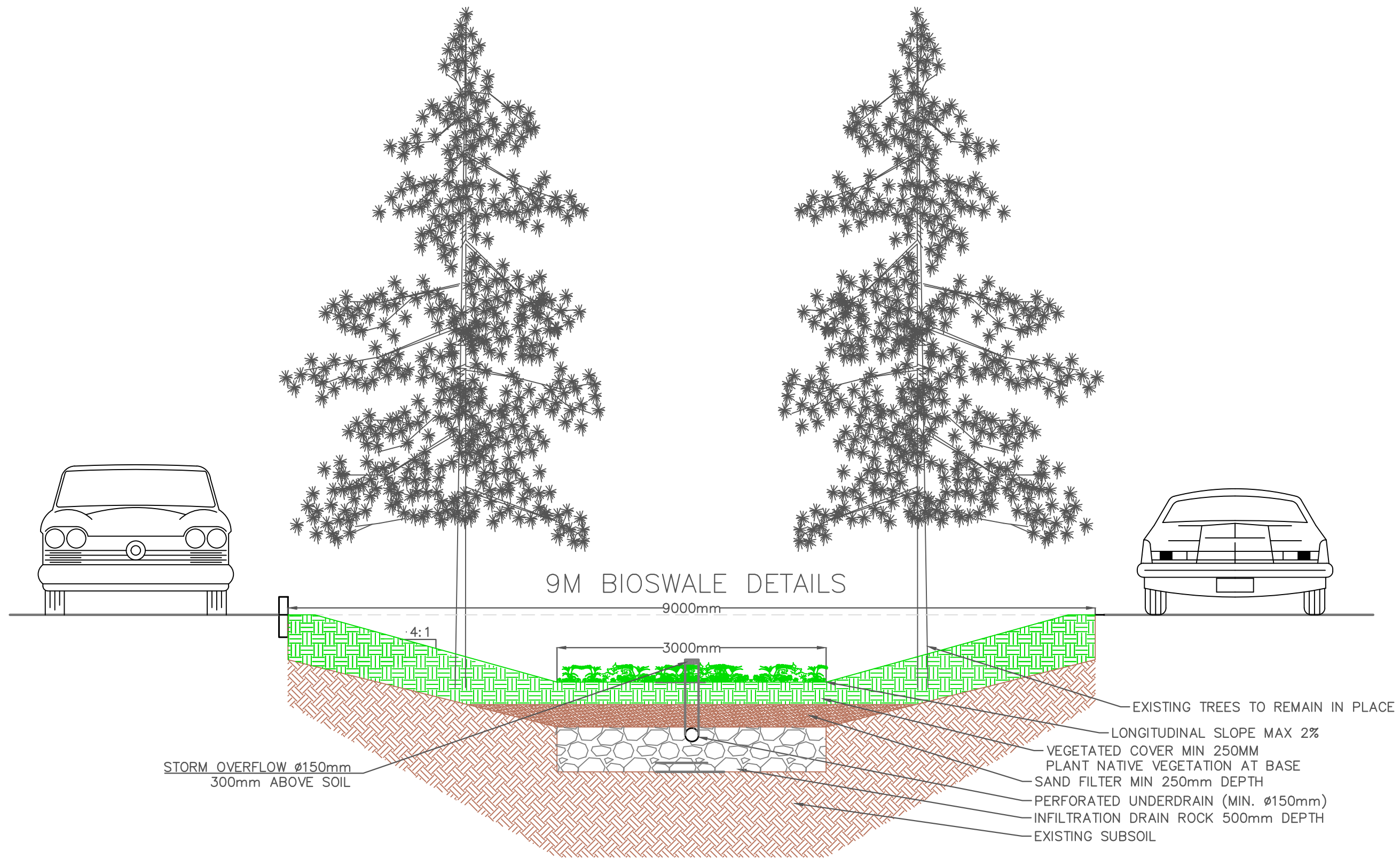

STORM OVERFLOW  $\phi$ 150mm  
300mm ABOVE SOIL

9M BIOSWALE DETAILS

9000mm

4:1

3000mm

EXISTING TREES TO REMAIN IN PLACE

LONGITUDINAL SLOPE MAX 2%

VEGETATED COVER MIN 250MM  
PLANT NATIVE VEGETATION AT BASE

SAND FILTER MIN 250mm DEPTH

PERFORATED UNDERDRAIN (MIN.  $\phi$ 150mm)

INFILTRATION DRAIN ROCK 500mm DEPTH

EXISTING SUBSOIL

ISSUED FOR CONSTRUCTION

TEAM  
12

W-1

DETAILED  
DESIGN

13/04/2021

DRAWN BY: J.S

REVIEWED  
BY: N.S

SCALE  
1:45

02/12/2020	R1
28/02/2021	R2
05/04/2021	R3
13/04/2021	R4

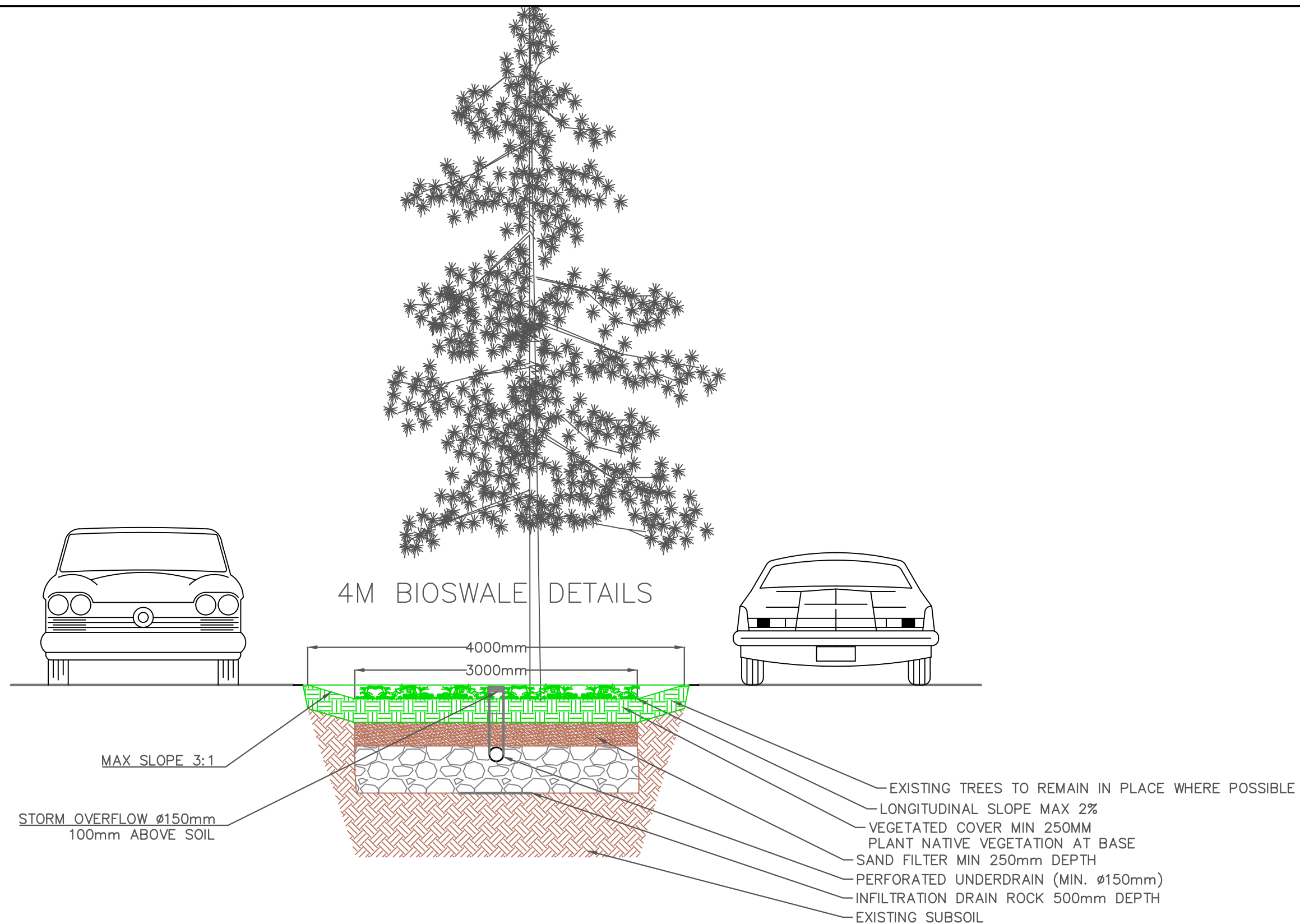

ISSUED FOR CONSTRUCTION

TEAM  
12

W-2

DETAILED  
DESIGN

13/04/2021

DRAWN BY: J.S

REVIEWED  
BY: N.S

SCALE  
1:45

02/12/2020	R1
28/02/2021	R2
05/04/2021	R3
13/04/2021	R4

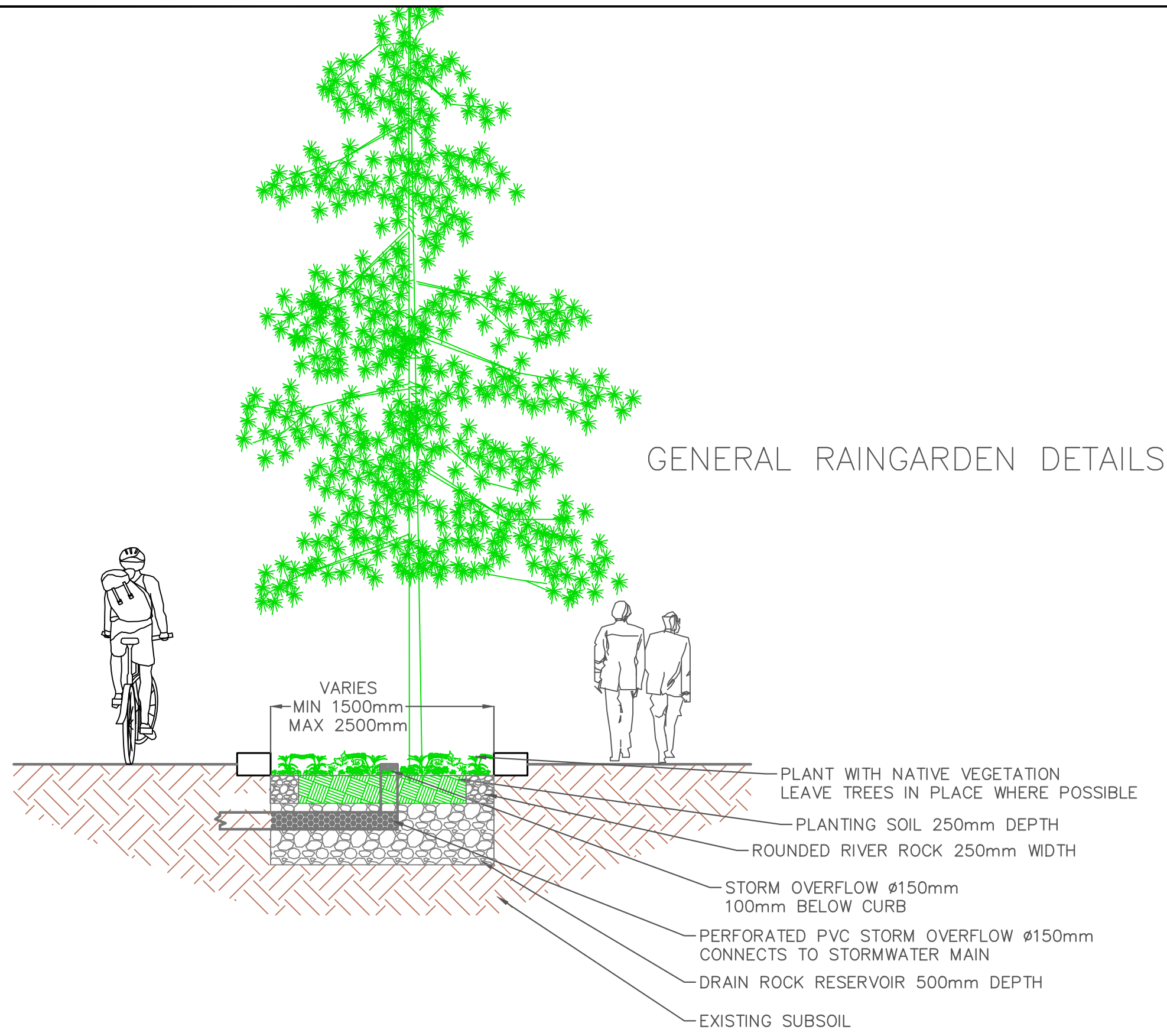

ISSUED FOR CONSTRUCTION

TEAM  
12

W-3

DETAILED  
DESIGN

13/04/2021

DRAWN BY: J.S

REVIEWED  
BY: N.S

SCALE  
1:40

02/12/2020	R1
28/02/2021	R2
05/04/2021	R3
13/04/2021	R4

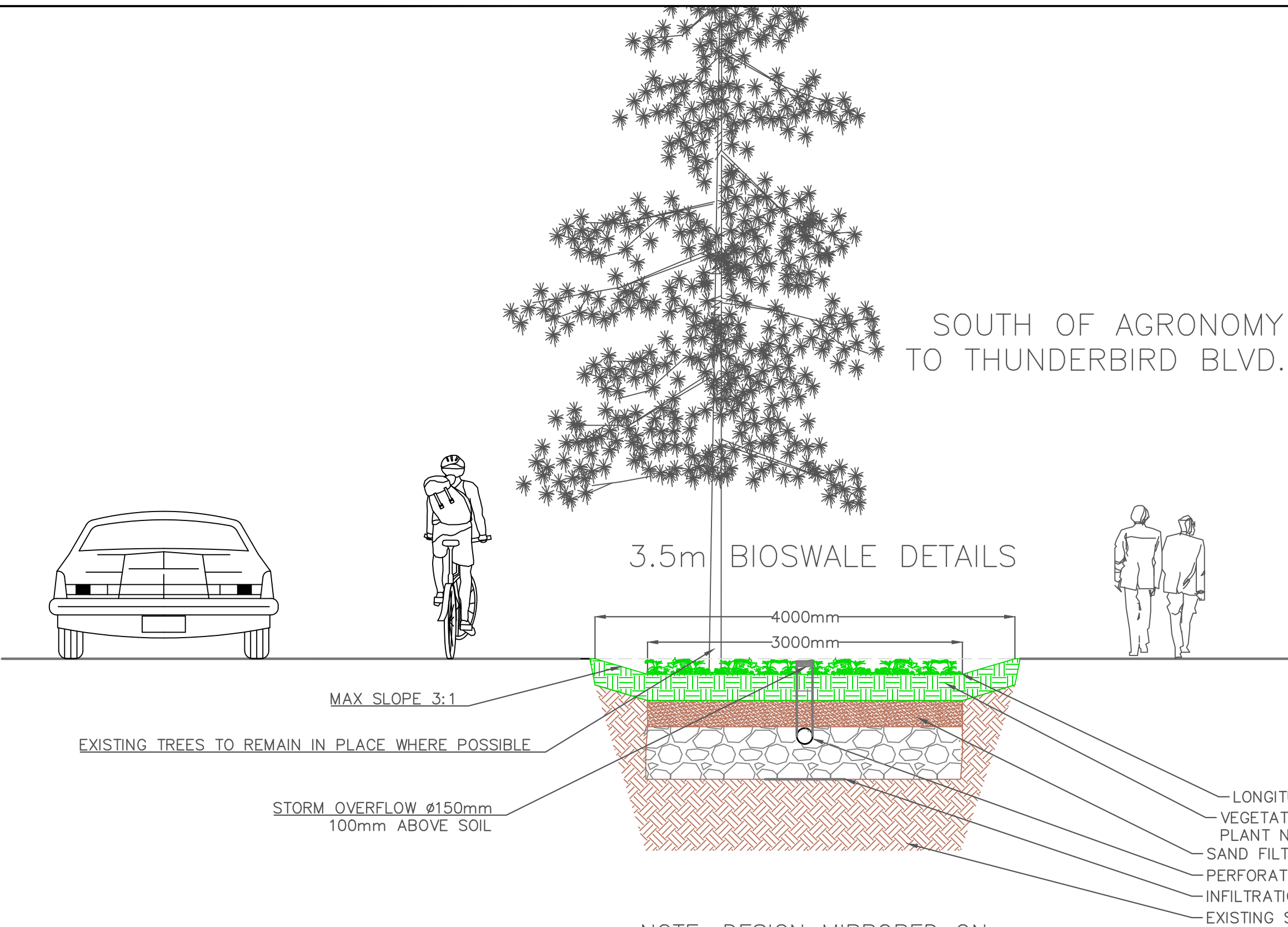

SOUTH OF AGRONOMY  
TO THUNDERBIRD BLVD.

3.5m BIOSWALE DETAILS

MAX SLOPE 3:1

EXISTING TREES TO REMAIN IN PLACE WHERE POSSIBLE

STORM OVERFLOW  $\phi 150\text{mm}$   
100mm ABOVE SOIL

- LONGITUDINAL SLOPE MAX 2%
- VEGETATED COVER MIN 250MM  
PLANT NATIVE VEGETATION AT BASE
- SAND FILTER MIN 250mm DEPTH
- PERFORATED UNDERDRAIN (MIN.  $\phi 150\text{mm}$ )
- INFILTRATION DRAIN ROCK 500mm DEPTH
- EXISTING SUBSOIL

NOTE: DESIGN MIRRORED ON  
SOUTHBOUND LANE

ISSUED FOR CONSTRUCTION

TEAM  
12

W-4

DETAILED  
DESIGN

13/04/2021

DRAWN BY: J.S

REVIEWED  
BY: N.S

SCALE  
1:40

04/12/2020	R1
04/03/2021	R2
07/04/2021	R3

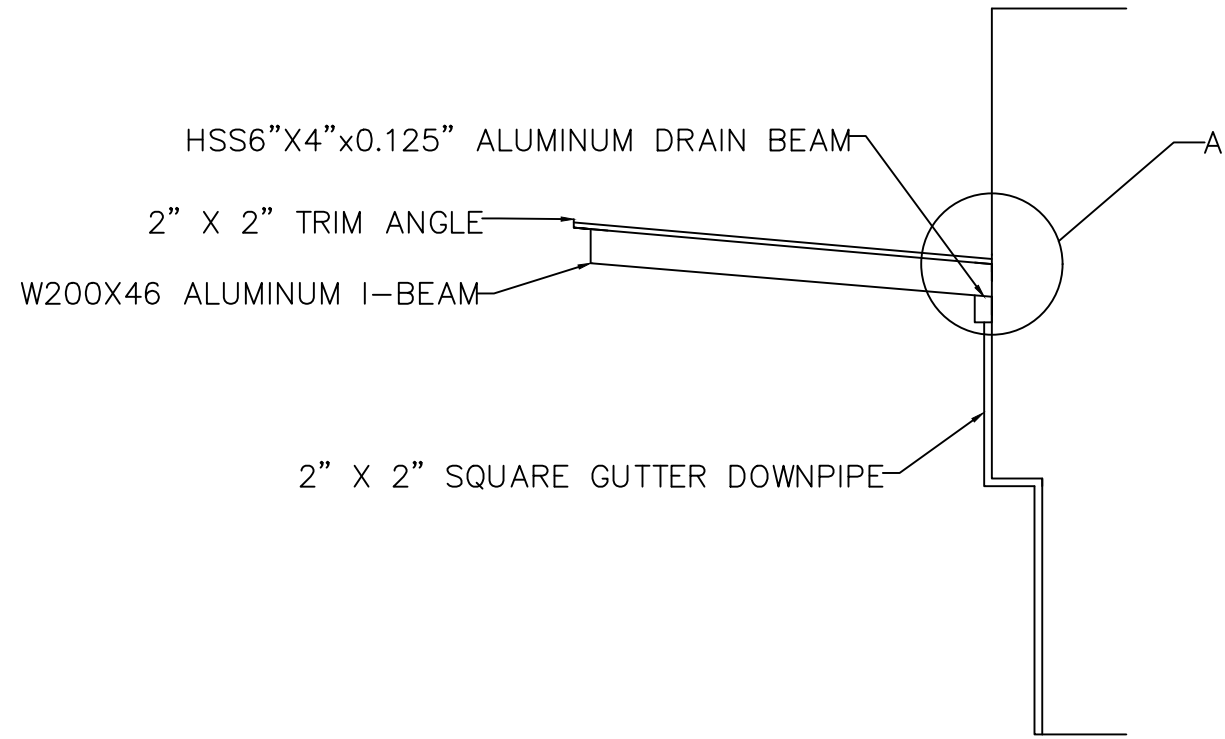

ELEVATION VIEW

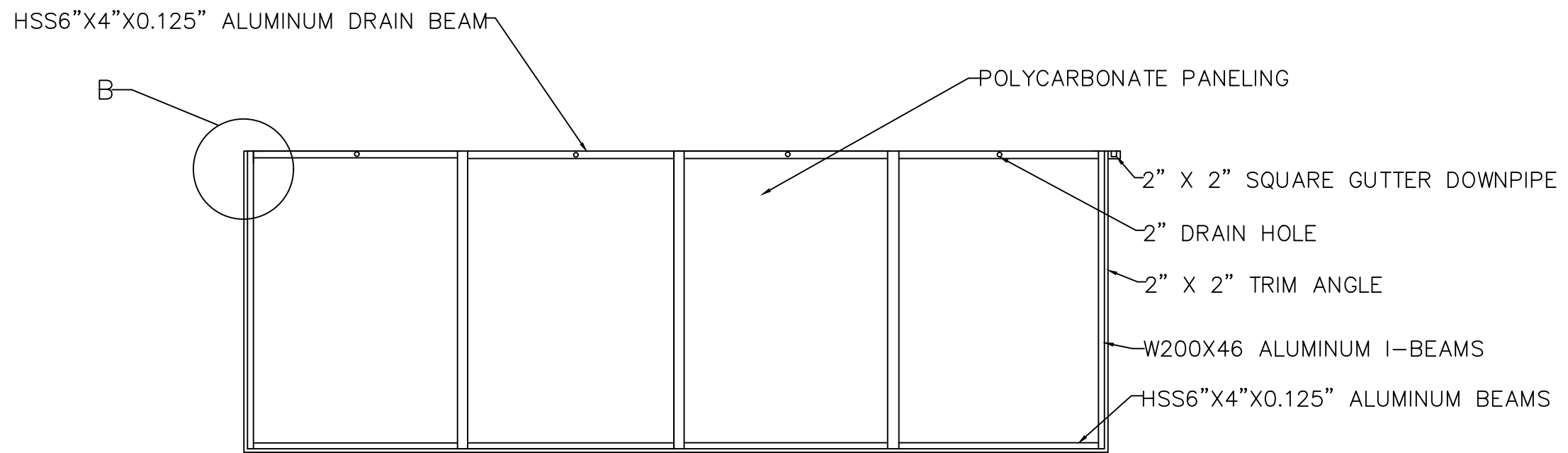

PLAN VIEW

ISSUED FOR CONSTRUCTION

TEAM  
12

S-1

DETAILED  
DESIGN

07/04/2021

DRAWN BY: J.L.

SCALE  
1:45

04/12/2020	R1
04/03/2021	R2
07/04/2021	R3

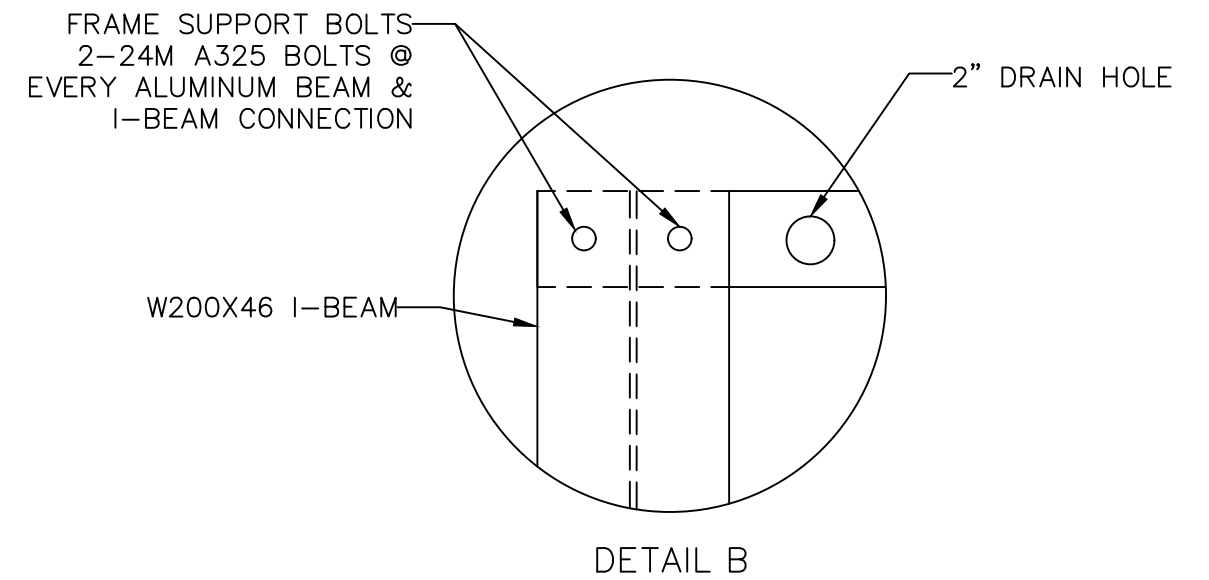
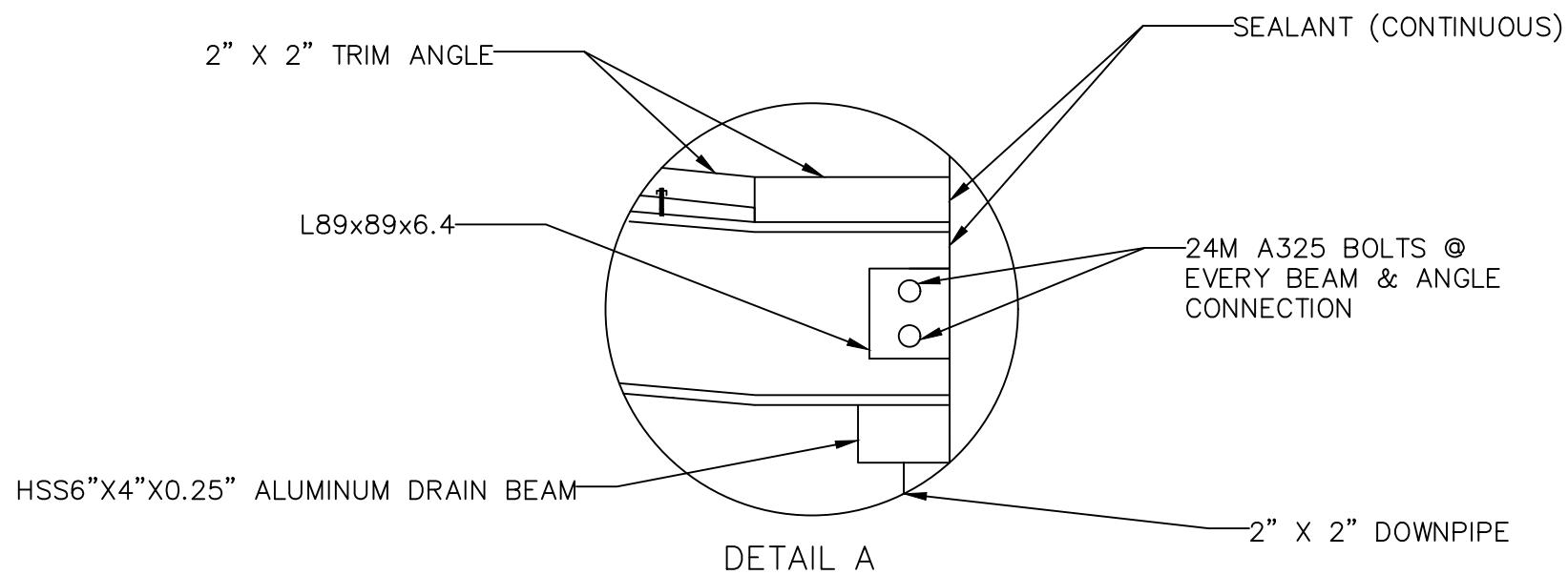

ISSUED FOR CONSTRUCTION

TEAM  
12

S-2

DETAILED  
DESIGN

07/04/2021

DRAWN BY: J.L

SCALE  
1:6



Curb Extensions: Surrey R.28.3

Intersection Curb Letdown: Surrey R.26

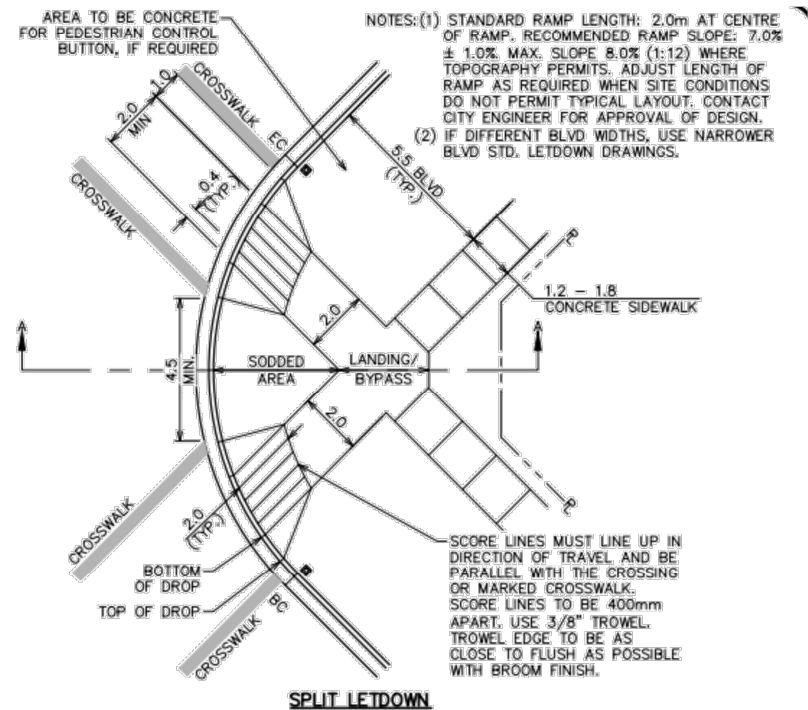

Curb Dimensions: CoV C4.1 Type A

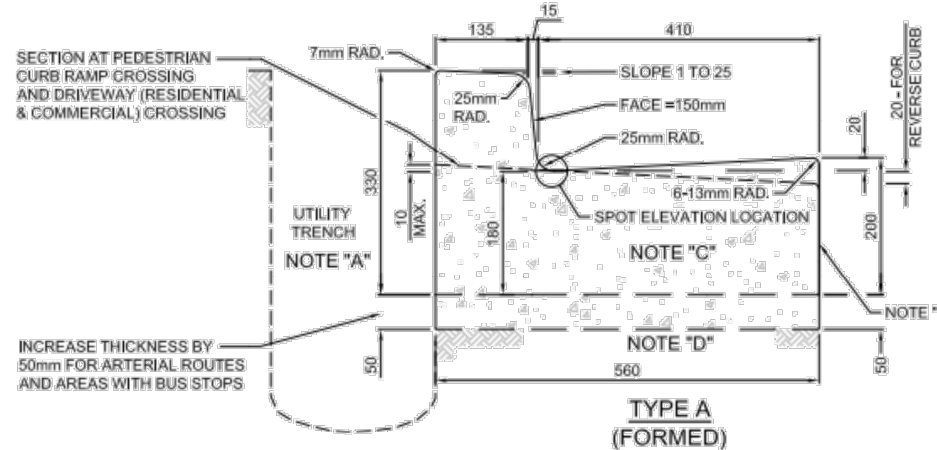

- DETAIL B -

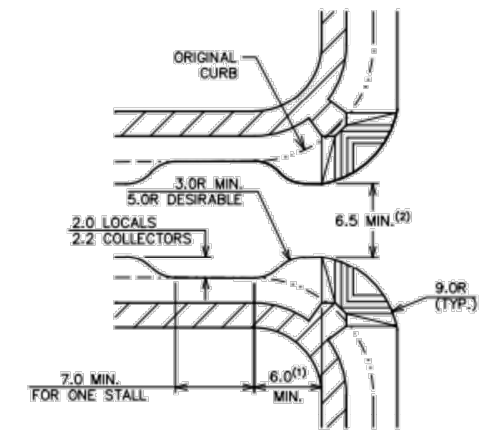

**INTERSECTION CURB EXTENSION DETAILS**

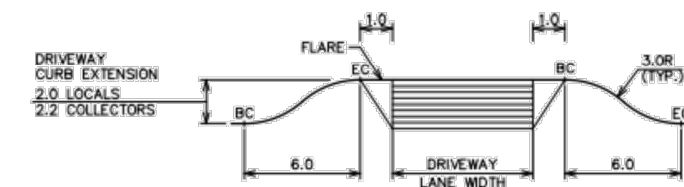

**DRIVEWAY/LANE DETAIL**

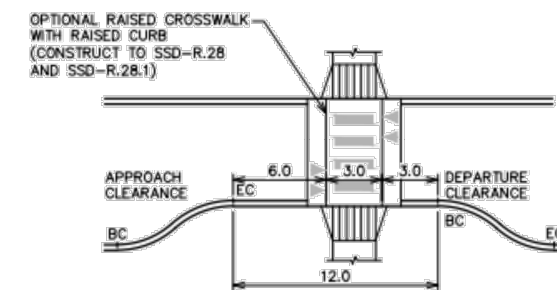

**MIDBLOCK CROSSING DETAIL**

- DETAIL C -

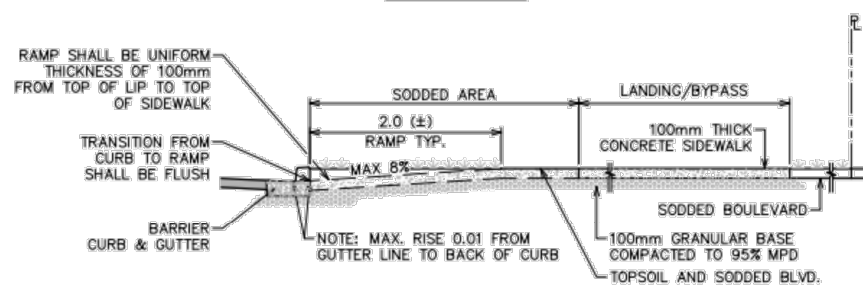

**SECTION A-A CURB RAMP**

- DETAIL A -

Note: Details obtained from the City of Vancouver (CoV) Standard Detail Drawings Package (2018) and the City of Surrey Supplement to the MMCD Drawings (2018). For full drawings and additional construction considerations please see these documents.

ISSUED FOR CONSTRUCTION

PRODUCED BY AN AUTODESK STUDENT VERSION

TEAM 12

D-1

DETAILED DESIGN

05/04/2021

DRAWN BY: N.W.

REVIEWED BY: J.S.

N.T.S.

Sign Posts: CoV C19.2

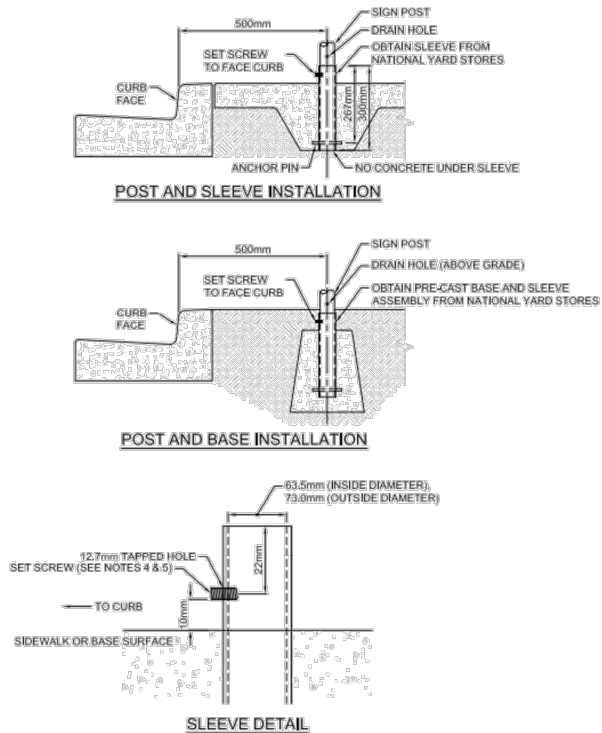

- DETAIL D -

Transit Posts: CoV C19.3

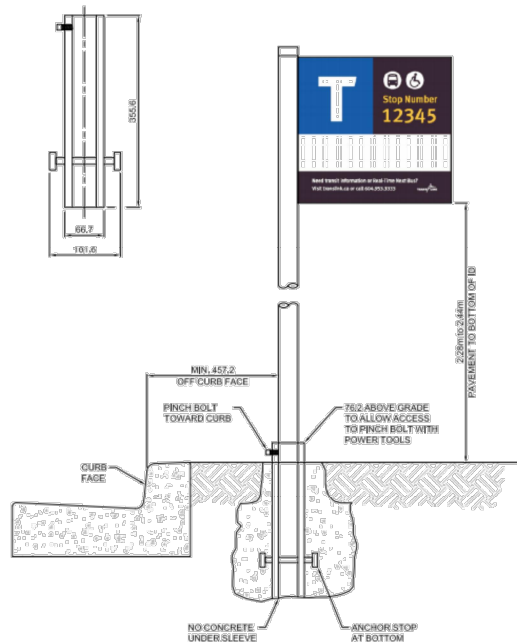

- DETAIL E -

Light Posts: Surrey R.E.3

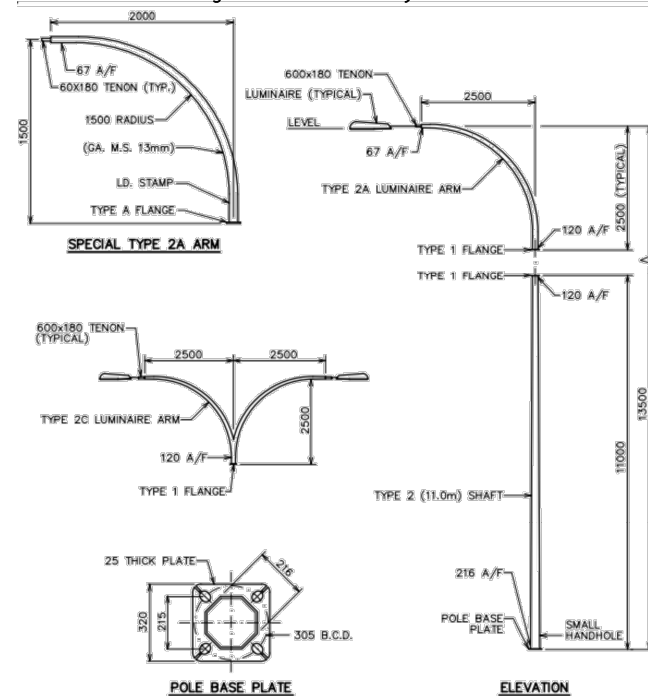

- DETAIL F -

Light Post Concrete Base: CoV CE1.1

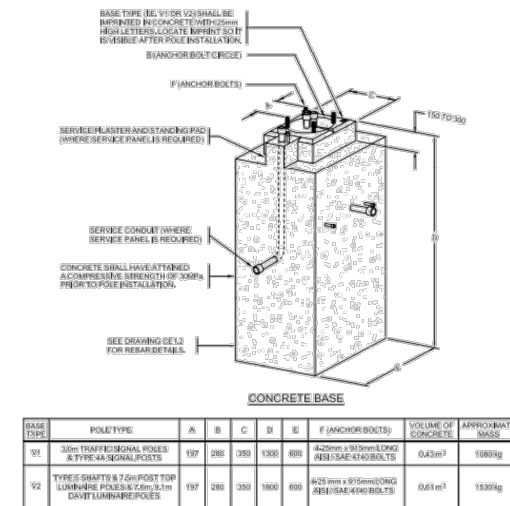

- DETAIL G -

Traffic Signal: CoV E4.17

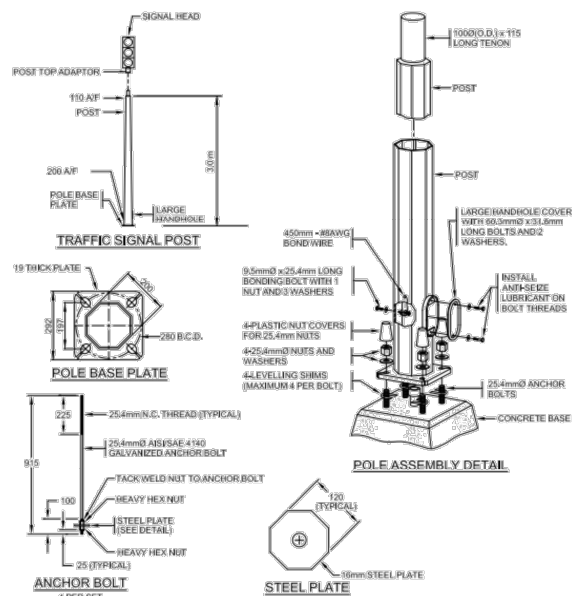

- DETAIL H -

RRFB Post: Washington State (2)

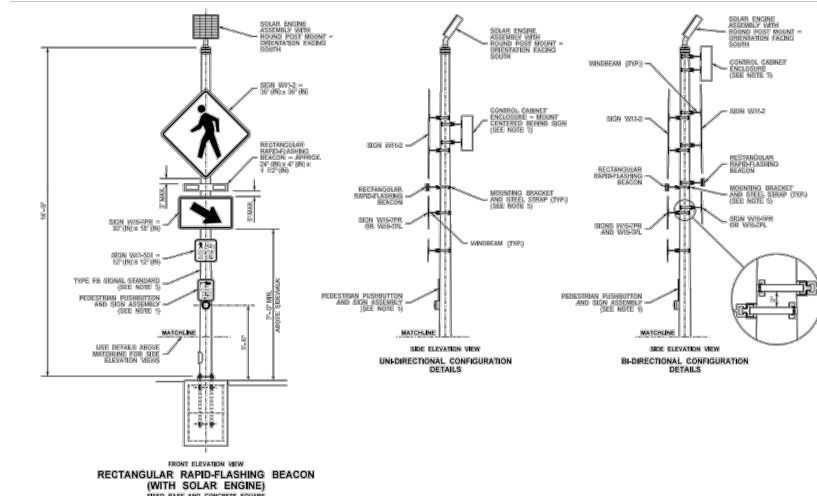

- DETAIL I -

- Notes:
- (1) Details obtained from the City of Vancouver (CoV) Standard Detail Drawings Package (2018) and the City of Surrey Supplement to the MMCD Drawings (2018). For full drawings and additional construction considerations please see these documents.
  - (2) Sourced from Washington State Department of Transportation RRFB Details Sheet 2 (2018)

ISSUED FOR CONSTRUCTION

Fire Hydrant: CoV W4.2

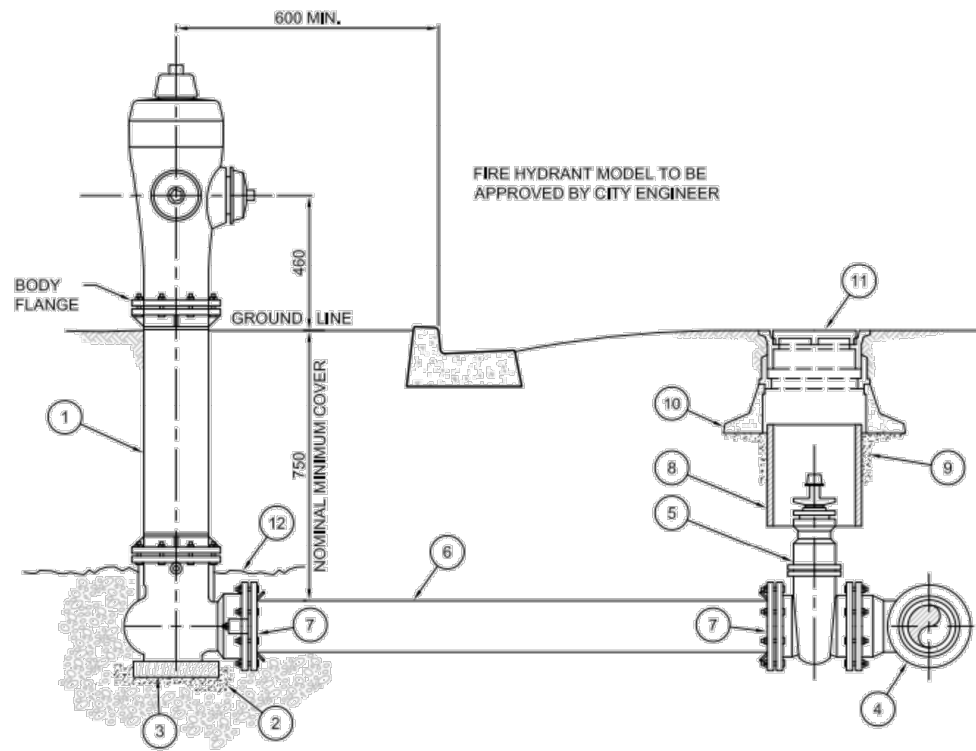

- DETAIL J -

Catch Basins: CoV S11.4

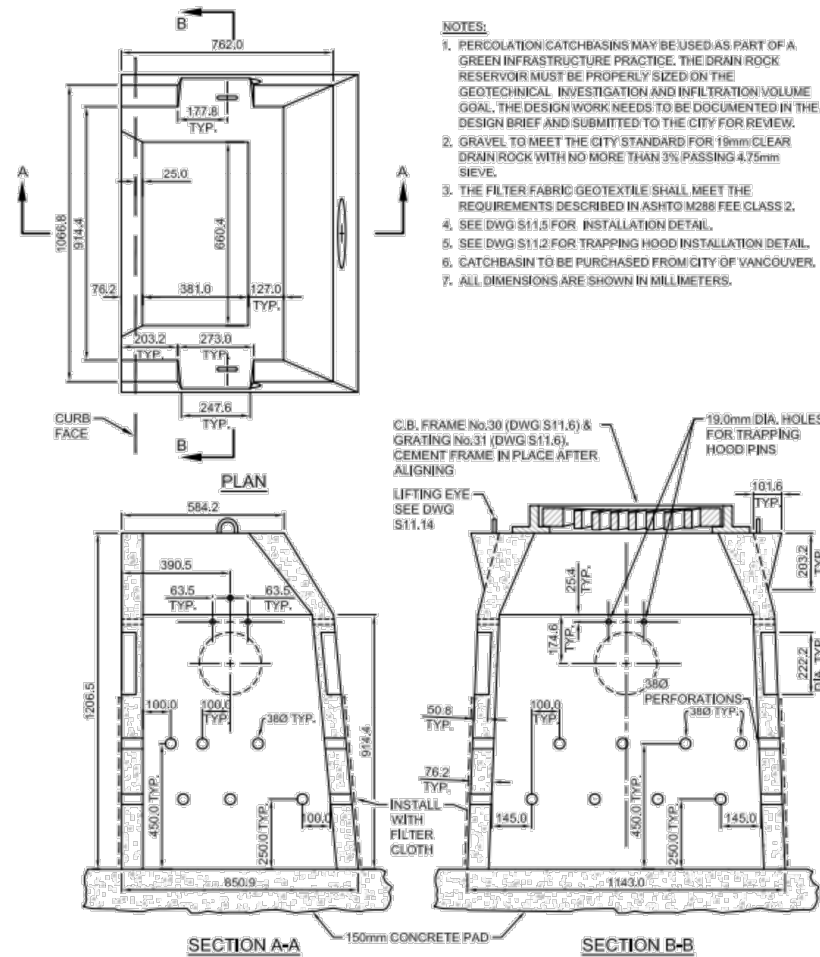

- DETAIL K -

Catch Basin Grate : CoV S11.7

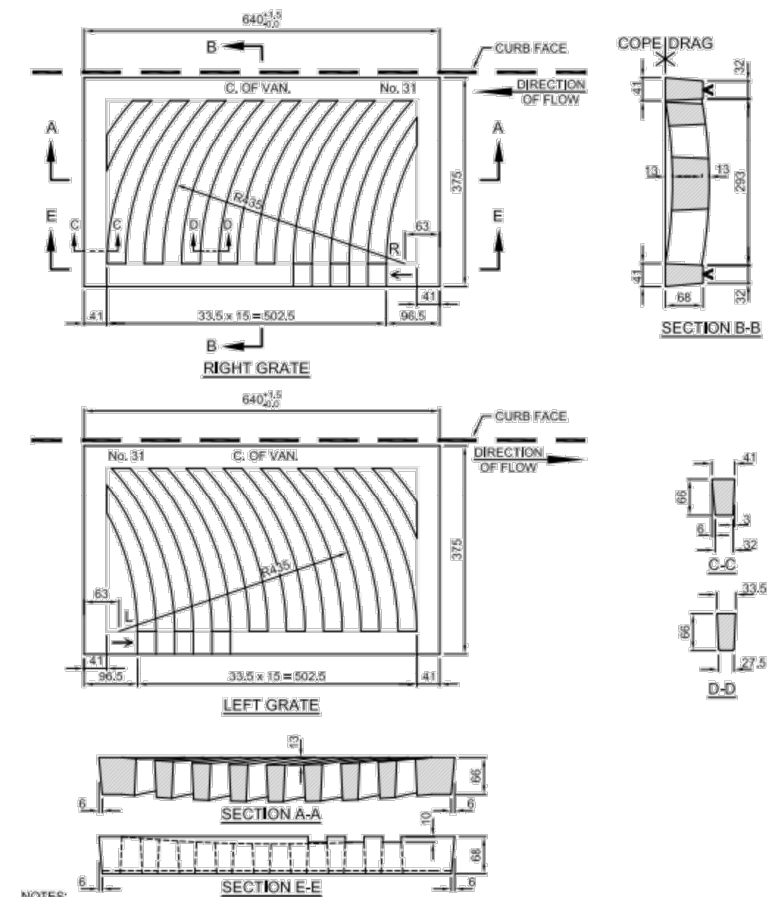

- DETAIL L -

Note: Details obtained from the City of Vancouver (CoV) Standard Detail Drawings Package (2018) and the City of Surrey Supplement to the MMCD Drawings (2018). For full drawings and additional construction considerations please see these documents.

ISSUED FOR CONSTRUCTION