

UBC Social Ecological Economic Development Studies (SEEDS) Sustainability Program  
Student Report

**Living Roofs and Low Impact Design**

**Jericho Bankston, Sara Duffin, Jaldhi Gohil, Josh Harvey, Xue Li, Julia Lorimer, Xiadong Meng,  
Samaneh Gharedaghi Mollahajlo, Paula Moskal, Elnaz Moftakhari Kamrani Nejad, Lisa Nq,  
Jan Rodriguez, Derek Wong, Feng Wu, Shiyu Wu, Wenwen Zhuang**

**University of British Columbia**

**LARC 582E**

**Themes: Buildings, Biodiversity, Water**

**May 2018**

*Disclaimer: UBC SEEDS provides students with the opportunity to share the findings of their studies, as well as their opinions, conclusions and recommendations with the UBC community. The reader should bear in mind that this is a student project/report and is not an official document of UBC. Furthermore readers should bear in mind that these reports may not reflect the current status of activities at UBC. We urge you to contact the research persons mentioned in a report or the SEEDS Coordinator about the current status of the subject matter of a project/report.*





# Living Roofs and Low Impact Design

LARC 582E SUMMARY REPORT

Source: Storm Water  
Solutions



UBC Social Ecological Economic Development Studies (SEEDS) Sustainability Program  
Student Seminar Research Report

## Living Roofs and Low Impact Design

University of British Columbia  
LARC 582E - Special Topics Living Roof Seminar  
May, 2018

Disclaimer: "UBC SEEDS Sustainability Program provides students with the opportunity to share the findings of their studies, as well as their opinions, conclusions and recommendations with the UBC community. The reader should bear in mind that this is a student research project/report and is not an official document of UBC. Furthermore, readers should bear in mind that these reports may not reflect the current status of activities at UBC. We urge you to contact the research persons mentioned in a report or the SEEDS Sustainability Program representative about the current status of the subject matter of a project/report".

# Executive Summary

This document covers the integration of Low Impact Design systems and their use on pre-existing building structures for urban water mitigation benefits. Sites with underutilized rooftops, primarily parkades, were selected from the University of British Columbia campus as the area of focus, with one site selected from downtown Vancouver.

The seminar covered Living Green Roofs and the benefits they offer in terms of water mitigation off the ground plane, focusing on evapotranspiration and reducing overall water loads on the campus's stormwater management systems. Low impact design systems such as water retention, bioswales, rain gardens, green roofs and delayed infiltration were looked at as potential area strategies to improve water mitigation on site.

Based on prior research and established methods of calculating evapotranspiration rates and bioswale infiltration two students, Feng Wu and Jericho Bankston, developed a Living Green Roof Calculator that takes into consideration the water mitigation from all LID systems from the rooftop to the ground plan. This calculator allows designers to quickly understand required area to mitigate water on site and was used by all students to produce a consistent method of analyzing overall water mitigation through the various strategies.

The document presents each site as a different design project resulting in various final strategies for better water mitigation given current site conditions through the utilization of LID systems. Finally presenting UBC with a set of final recommendations on how to move forward and a conclusion of the benefits of LID systems on campus and in urban settings.



# ACKNOWLEDGEMENTS

The UBC Living Roofs project was developed by UBC SALA students for the UBC Social Ecological Economic Development Studies (SEEDS) Sustainability Program.

Thank you to Kevin Kong and academic advisor Daniel Roehr at greenskins lab for your ongoing contributions to this project. We would also like to thank Dr. Hans Schreier with the faculty of Land and Food Systems and David Matsubara with the City of North Vancouver for their support and guidance throughout the project.

# Table of Contents

## 1

### background.

Sites Explored

Introduction and Objectives

Methodology and Limitations

Living Roof Calculator

## 2

### guidelines.

Planning and Construction Considerations

Best practices for LID at UBC

## 3

### findings.

Fraser Parkade

Thunderbird Parkade

West Parkade

North Parkade

Stadium Neighborhood

Armories Hub

Kensington Place

## 4

### conclusion.



1

background.

**Understand and implement a low-impact development approach to stormwater management at the site scale to mitigate risk, respect the natural hydrology of the campus, and foster social engagement in the public realm.**





## Investigate

Stormwater runoff volumes of rooftops sites on the UBC Campus and in Downtown Vancouver.

Identify opportunities for increased biodiversity and social spaces through the introduction of living infrastructure.

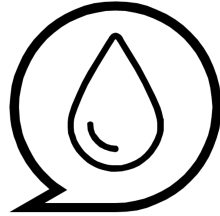

## Learn

The potential for stormwater reduction and other site specifics.



## Discuss

Design considerations and recommendations for the early integration of green roofs into the design process.

Integrate findings into the Green Building Plan.

# Sites Explored

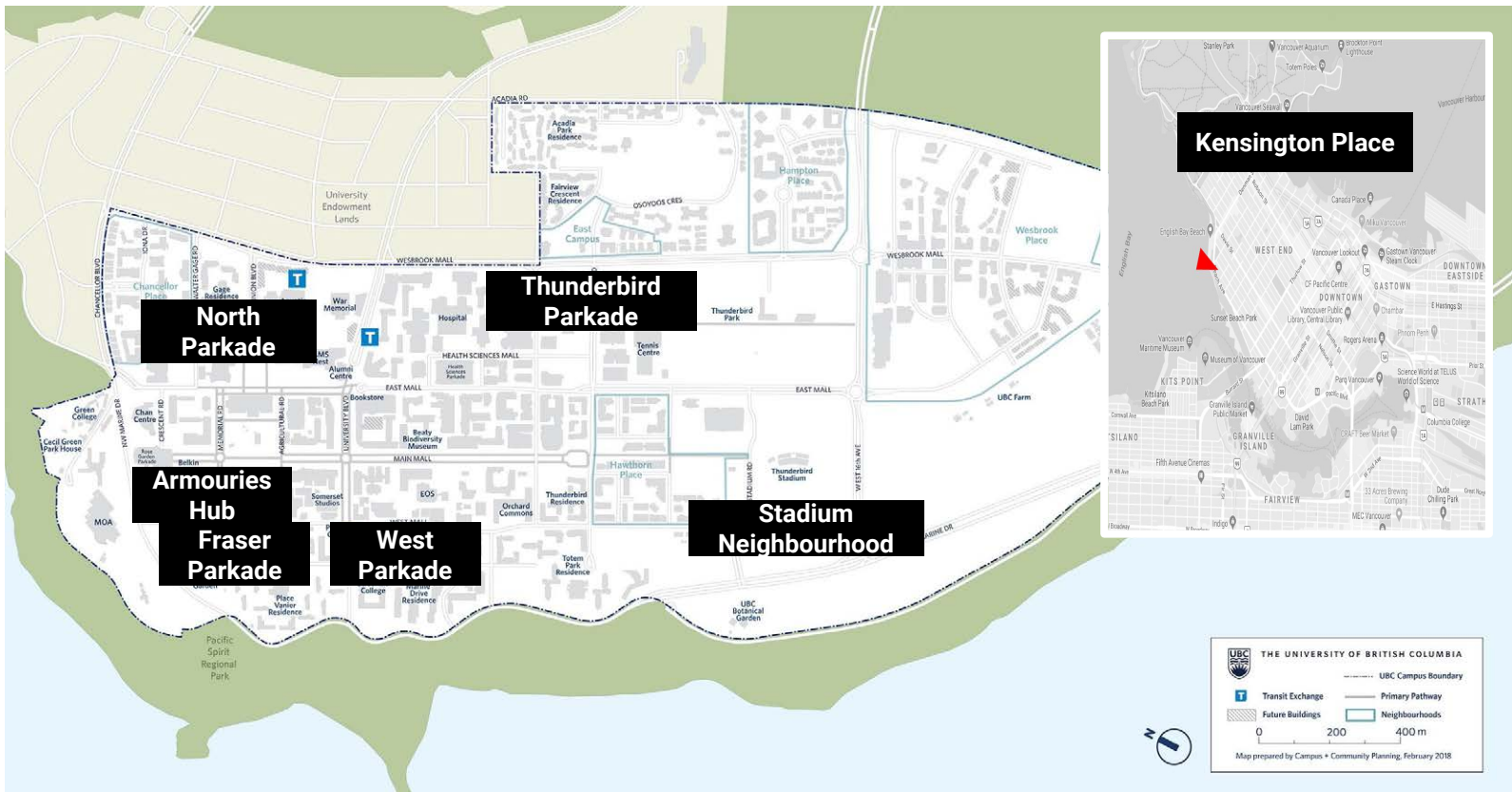



# Methodology

To calculate potential stormwater reduction, 2017 rainfall data from the Government of Canada's climate database was used in combination with evapotranspiration data for Vancouver, as well as the site specific runoff rate (calculated using the CN method). Information on annual rainfall in Vancouver was combined with a runoff curve number (CN) as specified by the TR-55 (a report that "presents simplified procedures for estimating runoff and peak discharges in small watersheds")(*Urban Hydrology for Small Watersheds TR-55*). The CN number is determined by the site's percentage of pervious surfaces (*Urban Hydrology for Small Watersheds TR-55*). In all cases, a CN of 98 was applied (the number used for roofs that are 100% impervious). The total roof area was multiplied by the runoff rate and the evapotranspiration rate (given the application of an extensive green roof) to find the percentage of potential stormwater reduction. The percentage of potential stormwater reduction was used as the primary driver for the proposed design solutions. Other considerations (such as climate appropriate plantings, and proposed infrastructure recommendations) were based on an analysis of existing site conditions, product availability and site specific feasibility.

Below: A Living Roof Calculator was constructed in excel to quickly run a variety of scenarios using 2017 precipitation data collected from Vancouver International Airport and sourced from the Government of Canada's historical data site.

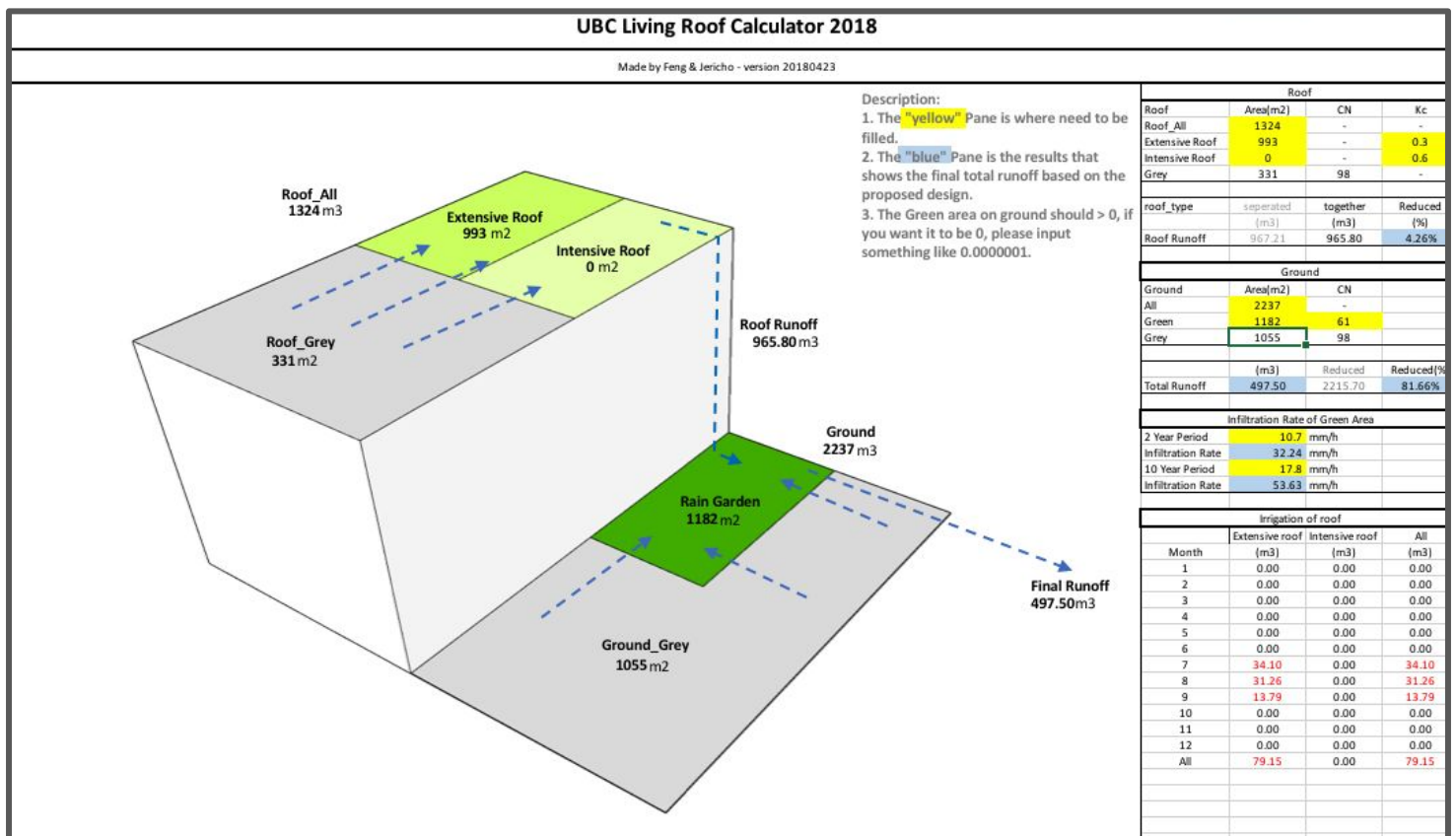

# Limitations

All data was sourced from credible sites however this field is still developing techniques by which to measure and provide estimates on things such as soil infiltration and plant evapotranspiration to name a few. This leaves final results as estimates rather than tried and true facts.

Other areas that potentially limited outcomes include site conditions, many sites had buildings which occupied most if not all of the land area available, this limited the ability to deal with rainwater on site. In many cases the surrounding area was not considered in regard to stormwater mitigation, however these adjacent sites would spill over potentially causing complications.

A 20 year rainfall event was not considered as current campus conditions would simulate flooding regardless of individual site solutions. Without large scale conversion to LID systems or an upscaling of stormwater management systems any 20 year rain event will pose flooding conditions.

The following are areas we feel limited the research.

- Lack of research into Crop Coefficient Values (Kc) and any one plant's ability to evapotranspire.
- Structural loading conditions and limitations of existing buildings.
- Lack of maintenance following implementation of designs.
- Plant site concerns:
  - Exposure or protection
  - Accessibility to plants for maintenance
  - Plant adaptability to site conditions
  - Visual (Green vs Grey roofs)

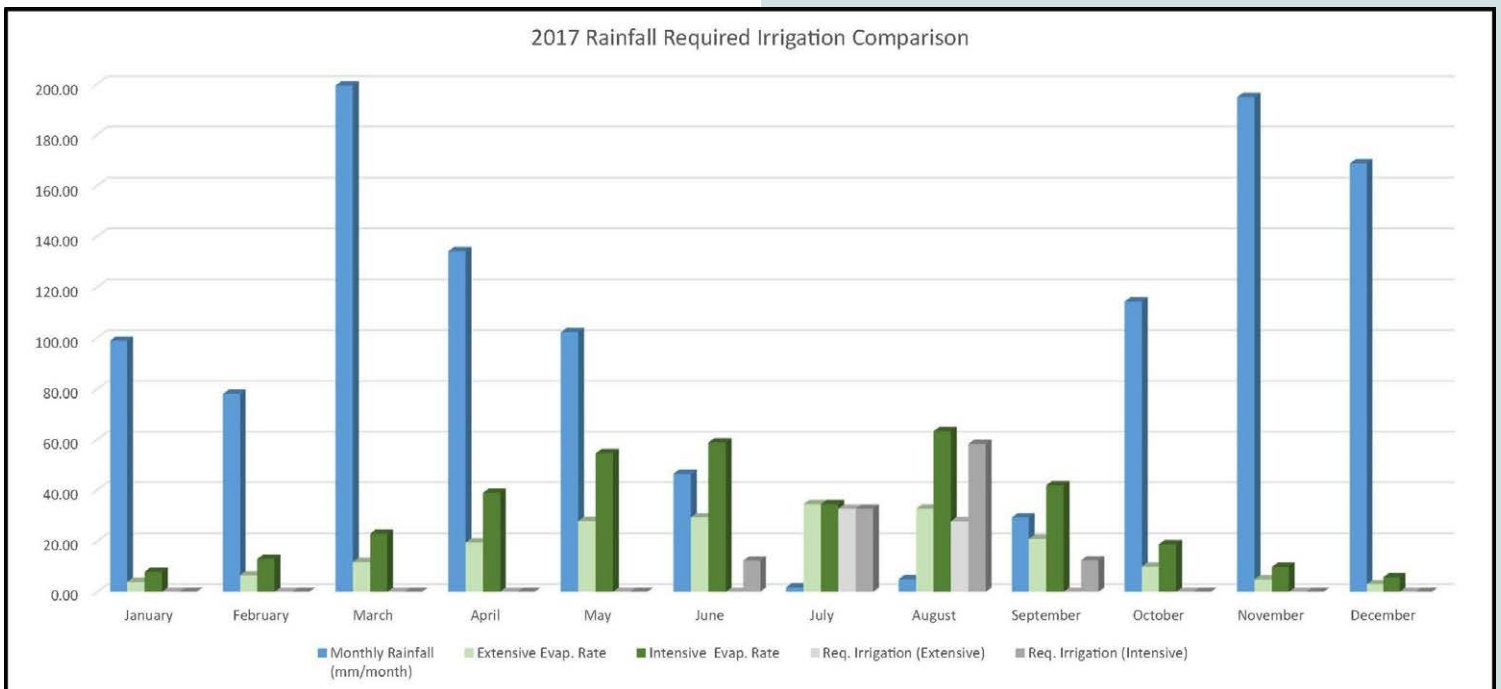

Source: Government of Canada, Historical Climate Data

2

guidelines.

# Planning & Construction Considerations

Planning a Green Roof should be a collaborative process, requiring coordination among various professionals throughout all phases of a project.

The diagrams to the right illustrate the complexity of these relationships, from the initial planning stages all the way through to the construction phase. These diagrams offer a great starting point in understanding the interrelationships between disciplines, and how early coordination and inclusion of these professionals will lead to a successful Green Roof project.

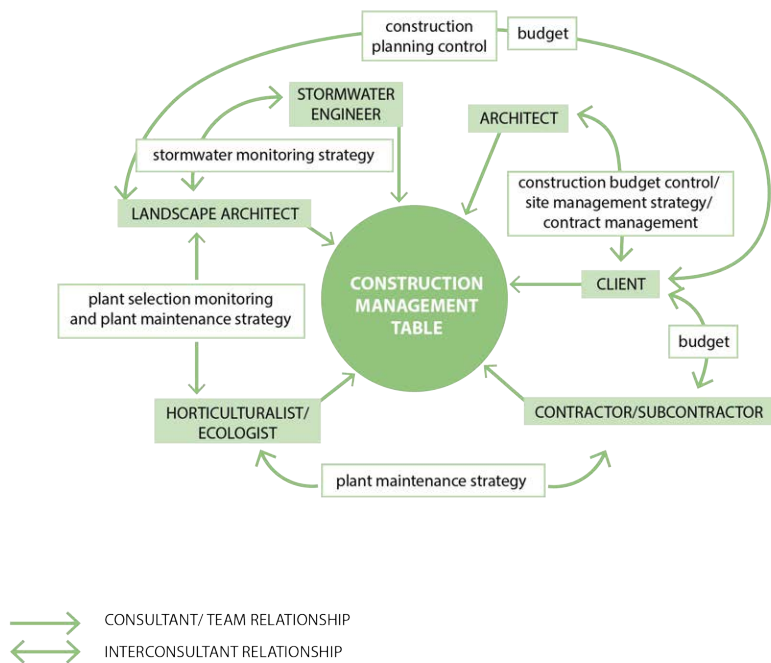
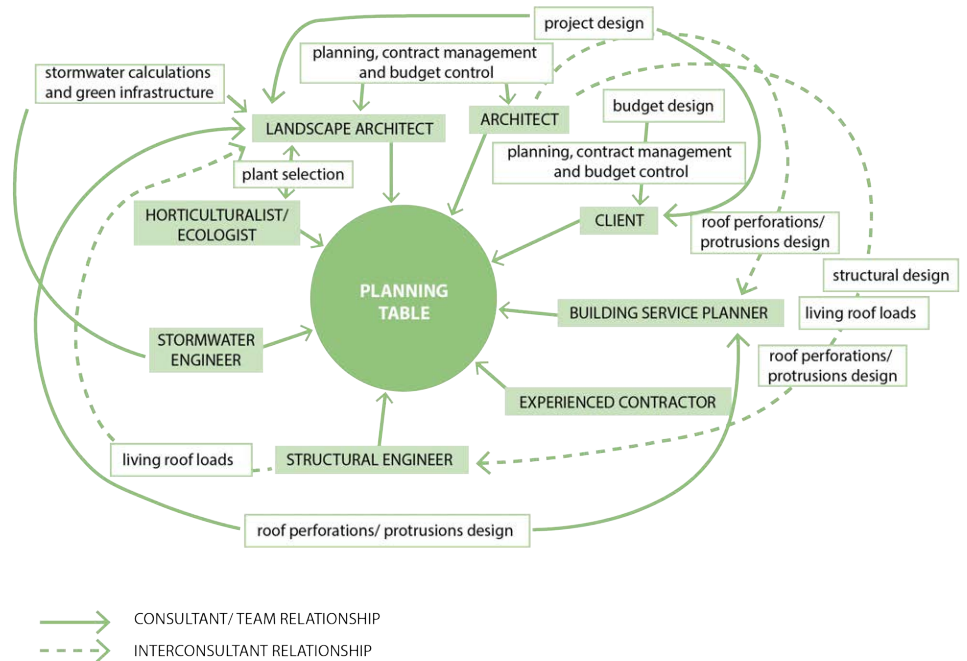

# Best Practices for LID at UBC

The following checklist was derived as a tool for managing best practices for LID at UBC. Initially taken from “*Living Roofs in Integrated Urban Water Systems*” by Daniel Roehr and Elizabeth Fassman-Beck, the original checklist was simplified and specifically geared towards use at UBC. As seen below, the checklist comprises of 7 main considerations: 1) site suitability, 2) design objectives, 3) planting design, 4) roof drainage design, 5) accessibility, 6) safety, and 7) final checks and review. This checklist is meant to initiate thinking of the Green Roof planning process more holistically, taking into account the various and complex considerations that go into designing a Green Roof.

	NOT ACHIEVED	ACHIEVED	CONSIDERATIONS
1 ASSESS SITE SUITABILITY	X	✓	<ul style="list-style-type: none"> <li>Structural capacity</li> <li>construction/installation and long-term maintenance</li> <li>Location &amp; number of perforations and protrusions</li> <li>Roof slope , mechanical services, exposure</li> </ul>
2 DESIGN OBJECTIVES	X	✓	<ul style="list-style-type: none"> <li>PRIMARY: rainfall retention</li> <li>SECONDARY: establish and maintain dense groundcover</li> <li>TERTIARY: biodiversity, water harvesting, visual impact, amenity/ social space, energy mitigation, ect.</li> </ul>
3 PLANTING DESIGN	X	✓	<p>SELECT PLANTING BASED ON:</p> <ul style="list-style-type: none"> <li>site conditions and presence/absence of irrigation</li> <li>maintenance requirements</li> <li>substrate characteristics and depth</li> </ul>
4 ROOF DRAINAGE DESIGN	X	✓	<ul style="list-style-type: none"> <li>Coordinate horizontal and vertical drainage</li> <li>Determine substrate composition, characteristics and depth using equations</li> <li>Select root barrier</li> <li>Coordinate materials with facade and rooftop for aesthetic consistency</li> <li>Identify permeable edging materials for living roof perimeter and around any protrusions or perforations</li> </ul>



# Best Practices for LID at UBC

	NOT ACHIEVED	ACHIEVED	CONSIDERATIONS
5 ACCESSIBILITY	X	✓	<p>ACCESSIBILITY CHECKLIST:</p> <ul style="list-style-type: none"> <li>• Frequent access by visitors?</li> <li>• Access only by maintenance crews?</li> <li>• Limited visitors and designated gathering space?</li> <li>• Protection of vegetation from visitors?</li> <li>• Life safety design elements?</li> <li>• Comfortable and safe roof access?</li> </ul>
6 SAFETY	X	✓	<ul style="list-style-type: none"> <li>• Parapet heights must meet minimum requirements set by local building codes</li> <li>• Lockable drainage points</li> <li>• Secure and safe working environment</li> </ul>
7 FINAL CHECKS & REVIEW	X	✓	<ul style="list-style-type: none"> <li>• Perform regulatory compliance calculations for stormwater mitigation objectives</li> <li>• Protocols established for ensuring waterproofing membrane and vegetation protection</li> <li>• Substrate depth meets or exceeds requirements rainfall retention</li> <li>• Loading verified by structural engineer</li> </ul>

Checklist: Roehr, Daniel, and Elizabeth Fassman-Beck. *Living Roofs in Integrated Urban Water Systems*. Abingdon, Oxon: Routledge, 2015.

3

findings.



# FRASER PARKADE

Jericho Bankston (M.UD) | Josh Harvey (M.Arch)



Fraser Parkade; Built 1980's

Located on Lower Mall & Memorial Road the Fraser Parkade is 4 floors of parking above grade with a half floor below. The parkade is a split level design with a terraced north facade and a roof that slopes partly north and partly south. The building footprint and roof area is approximately 4000m<sup>2</sup> and the remaining site area is 1500m<sup>2</sup>. Surrounding the parkade is a well traveled pedestrian path to the northeast, the First Nations Longhouse to the south, student housing to the southwest and the Asian Centre to the North. Notably the Nitobe Memorial Garden sits just to the Northwest corner and could be a future water storage/cleansing location.

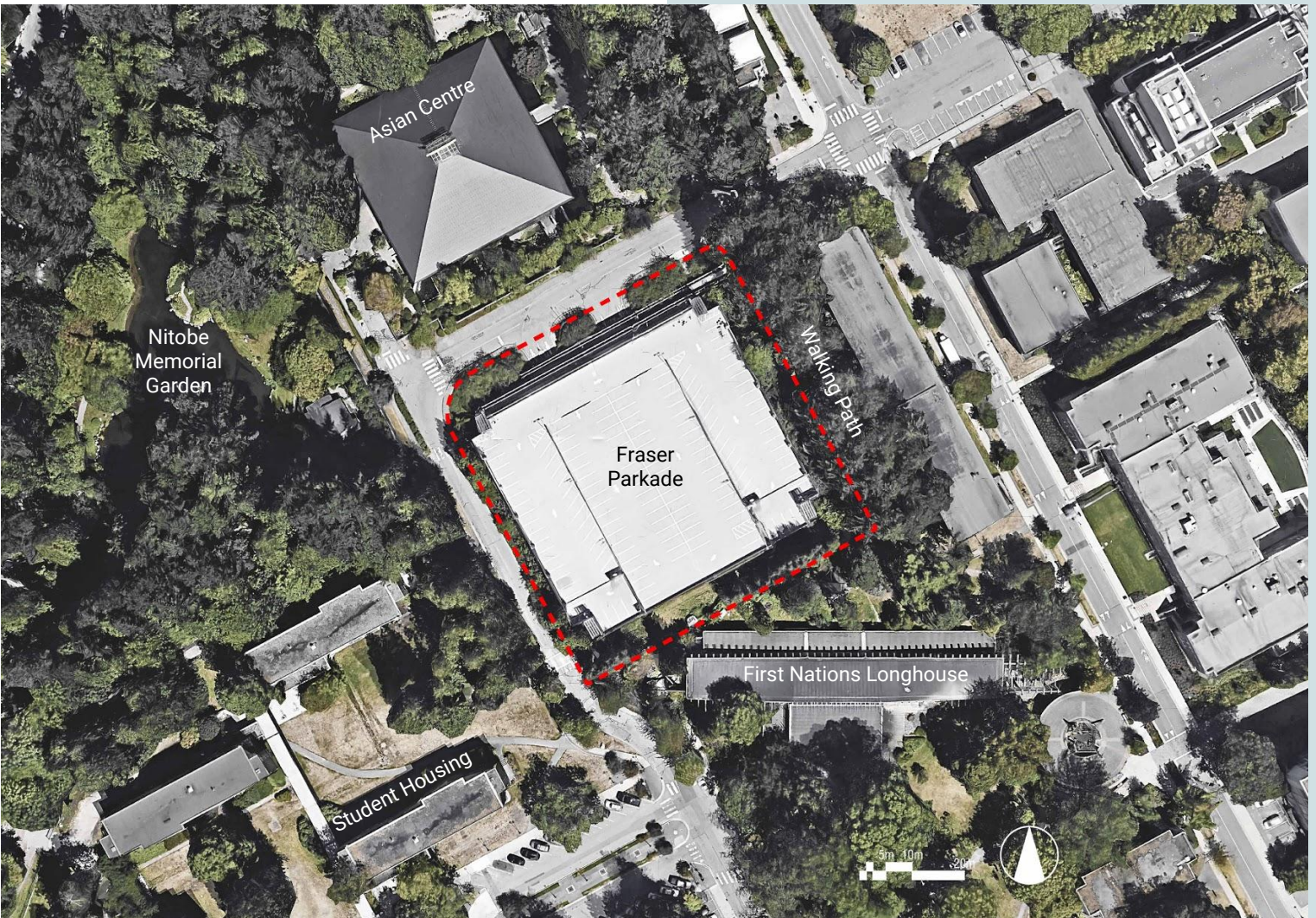

Fraser Parkade aerial map



# Extensive & Intensive Conditions

## Intensive Roof

The nature of the site a broad approach was tried first, looking at 100% intensive vs extensive roof types to give a base. The intensive roof type works for the Fraser Parkade because structurally it can withstand the increase weight load from the added topsoil. It also carries with it the benefit of a higher evapotranspiration rate reducing total roof water runoff by 10% or about.

Ground, bioswale and rain garden area sizes are held constant throughout as they are a product of area vs infiltration rate for a particular storm event rather than roof sizes. One challenge with intensive roof types are the extra required irrigation. For the 2017 year a 4000 sqm roof would require 465 m<sup>3</sup> of irrigation.

Intensive Roof			
Roof			
Roof	Area(m2)	CN	Kc
Roof_All	4000	-	-
Extensive Roof		-	0.3
Intensive Roof	4000	-	0.6
Grey	0	98	-
roof_type	seperated (m3)	together (m3)	Reduced (%)
Roof Runoff	2743.43	2743.43	9.98%
Ground			
Ground	Area(m2)	CN	
All	1500	-	
Green	1250	61	
Grey	250	98	
	(m3)	Reduced	Reduced(%)
Total Runoff	1176.88	3013.68	71.92%
Infiltration Rate of Green Area			
2 Year Period	10.7 mm/h		
Infiltration Rate	47.08 mm/h		
10 Year Period	17.8 mm/h		
Infiltration Rate	78.32 mm/h		

## Extensive Roof

Extensive roof types often have the benefit of requiring less irrigation yearly as well as sunlight intensity. The tradeoff however is a significantly lower evapotranspiration rate of 5.5% with a yearly irrigation requirement of 242m<sup>3</sup> of irrigation, almost half that of the intensive roof.

Other benefits of an extensive roof system is lower maintenance, cheaper installation costs, a simpler construction system and a lighter overall weight allowing for further application to a variety of building types. This method is the most universal but often lacks spatial design qualities instead focusing on added technical benefits such as water mitigation and system load reductions rather than public amenities or other benefits.

Extensive Green Roof			
Roof			
Roof	Area(m2)	CN	Kc
Roof_All	4000	-	-
Extensive Roof	4000	-	0.3
Intensive Roof	0	-	0.6
Grey	0	98	-
roof_type	seperated (m3)	together (m3)	Reduced (%)
Roof Runoff	2880.21	2880.21	5.49%
Ground			
Ground	Area(m2)	CN	
All	1500	-	
Green	1250	61	
Grey	250	98	
	(m3)	Reduced	Reduced(%)
Total Runoff	1206.95	2983.61	71.20%
Infiltration Rate of Green Area			
2 Year Period	10.7 mm/h		
Infiltration Rate	47.08 mm/h		
10 Year Period	17.8 mm/h		
Infiltration Rate	78.32 mm/h		

# Optimized & 10 Year Conditions

## Optimized Roof

The optimized condition is believed to be the best allocation of resources given irrigation needs of selected plant species as well as cost considerations. A hybrid roof is ideal for this particular parkade, using both extensive and intensive roof types 5.5% of water can be evapotranspiration from the rooftop. The required irrigation for the chosen plant species needs an extra 247m<sup>3</sup> of water which can be collected and stored in adjacent retention ponds or in a water cistern on site. In normal rain events the LID systems implemented can mitigate 100% of stormwater on site. Given a 10 year rain event however the site is not big enough to accommodate the bioswale necessary to deal with the 17.8mm of rain per hour as we exceed the maximum infiltration of our bioswale at 78.3mm per hour, and most LID systems can only accommodate up to 70mm per hour of infiltration.

Optimized Roof			
Roof			
Roof	Area(m2)	CN	Kc
Roof_All	4000	-	-
Extensive Roof	3650	-	0.3
Intensive Roof	150	-	0.6
Grey	200	98	-
roof_type	seperated (m3)	together (m3)	Reduced (%)
Roof Runoff	2883.46	2882.03	5.44%
Ground			
Ground	Area(m2)	CN	
All	1500	-	
Green	1250	61	
Grey	250	98	
	(m3)	Reduced	Reduced(%)
Total Runoff	1207.34	2983.22	71.19%
Infiltration Rate of Green Area			
2 Year Period	10.7 mm/h		
Infiltration Rate	47.08 mm/h		
10 Year Period	17.8 mm/h		
Infiltration Rate	78.32 mm/h		

## 10 Year Optimized Roof





















Recognizing the importance of designing for disasters or extreme scenarios a fourth and final condition was realized looking specifically at dealing with a 10 year rain event. All things were held constant with the exception of the area of bioswale on the ground plane. What was discovered is that the current ground area available is not enough to mitigate 100% of water on site. Every square meter must be allotted to LID systems if 100% water mitigation is desired, currently not something possible as existing conditions and the buildings location on site limits the implementation of this. Ideally given the site and roof areas a minimum of 1500m<sup>2</sup> is required of LID systems, current conditions allow for 1250m<sup>2</sup> at a maximum. Even with 1500m<sup>2</sup> of LID systems in place a maximum infiltration rate of 65mm per hour can only be achieved.

10 Year Optimized Roof			
Roof			
Roof	Area(m2)	CN	Kc
Roof_All	4000	-	-
Extensive Roof	3600	-	0.3
Intensive Roof	250	-	0.6
Grey	150	98	-
roof_type	seperated (m3)	together (m3)	Reduced (%)
Roof Runoff	2877.95	2876.60	5.61%
Ground			
Ground	Area(m2)	CN	
All	1500	-	
Green	1500	61	
Grey	0	98	
	(m3)	Reduced	Reduced(%)
Total Runoff	985.83	3204.73	76.48%
Infiltration Rate of Green Area			
2 Year Period	10.7 mm/h		
Infiltration Rate	39.23 mm/h		
10 Year Period	17.8 mm/h		
Infiltration Rate	65.27 mm/h		



# Suggested Plants

Plants have been selected based on water consumption and required sunlight intensity. A variety were chosen to show diversity in species and low maintenance potential.

Green Roof Plant Schedule						
	Species	Name	Type	Water Consumption	Height	Spread
	<i>Lobularia maritima</i>	Sweet Alyssum	Annual		4"	6-12"
	<i>Sedum Albroseum</i>	Autumn Joy Stonecrop	Perennial		18-24"	18-24"
	<i>Sedum Bertram</i>	Bertram Anderson Stonecrop	Perennial		4-6"	12-18"
	<i>Lamium Beacon</i>	Beacon Silver Creeping Lamium	Ground Cover		6"	24"
	<i>Sesleria Caerulea</i>	Bloor Moor Grass	Ground Cover		10"	12"
	<i>Calendula Officinalis</i>	Calendula Pot Marigold	Annual		12-18"	12"
	<i>Ceratostigma Plumbagnoides</i>	Blue Leadwort	Perennial		12"	12-18"
	<i>Geranium Cambridge</i>	Cambridge Cranesbill	Perennial		10"	18-36"
	<i>Sedum Autumn Fire</i>	Autumn Fire	Perennial		18-24"	18-24"
	<i>Sedum Spectabile Neon</i>	Neon Tall Stonecrop	Perennial		18-24"	18-24"

# Optimized Results

The optimized results for the Fraser Parkade were not intuitive. With limited space to work with on the ground LID systems combined with creative design were required. By utilizing adjacent properties as well as recognizing the need to irrigate the urban agriculture as well as the rest of the green roof alternative strategies for water collection were used such as storage in the adjacent ponds as well as collection tanks in the basement of the parkade.

The results are a layering of systems to solve an increasingly complex water problem. While this design is able to mitigate the 2017 precipitation amount as well as 2 year rainfall events it struggles in 10 year rain events. A significant amount of water storage can be utilized through the adjacent ponds and onsite storage tanks allowing this location to serve as grey water irrigation for surrounding sites.

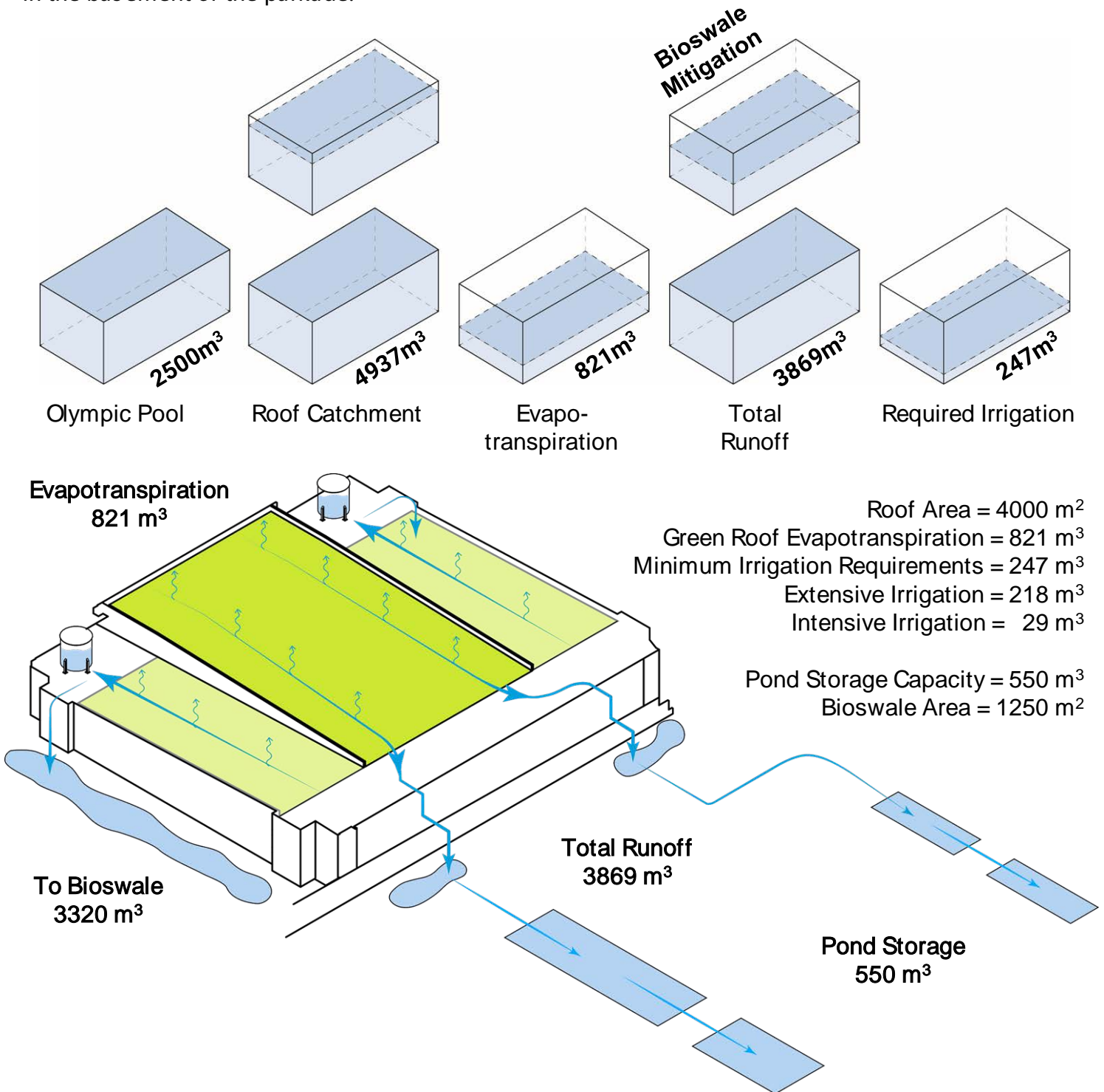

# Roof Plan

The roof of Fraser Parkade is an underutilized space with huge potential. Neither overlooked by surrounding buildings nor a useful vantage point, the roof is currently a forgotten space. However, a green roof that combines rainwater mitigation with useful amenity space can transform the roof into a destination for students and visitors.

The plan below suggests how Fraser Parkade might be programmed to take advantage of a green roof. Because the roof structure is made of opposing ramps, amenity spaces are arranged according to slope and orientation. A student community garden is located on the sunny southwest incline while an amphitheatre with

terraced seating and a grassy picnic area occupies the larger central ramp. A beer garden on several terraced decks overlooks the northeast pedestrian path and nearby forest.

Along the north, where the roof is nominally flat, there is a pavilion to house a covered garden work area, performance stage, and bar, as well as washrooms and service spaces. Existing stairs at each corner provide exiting and can be paired with new elevators for universal design.

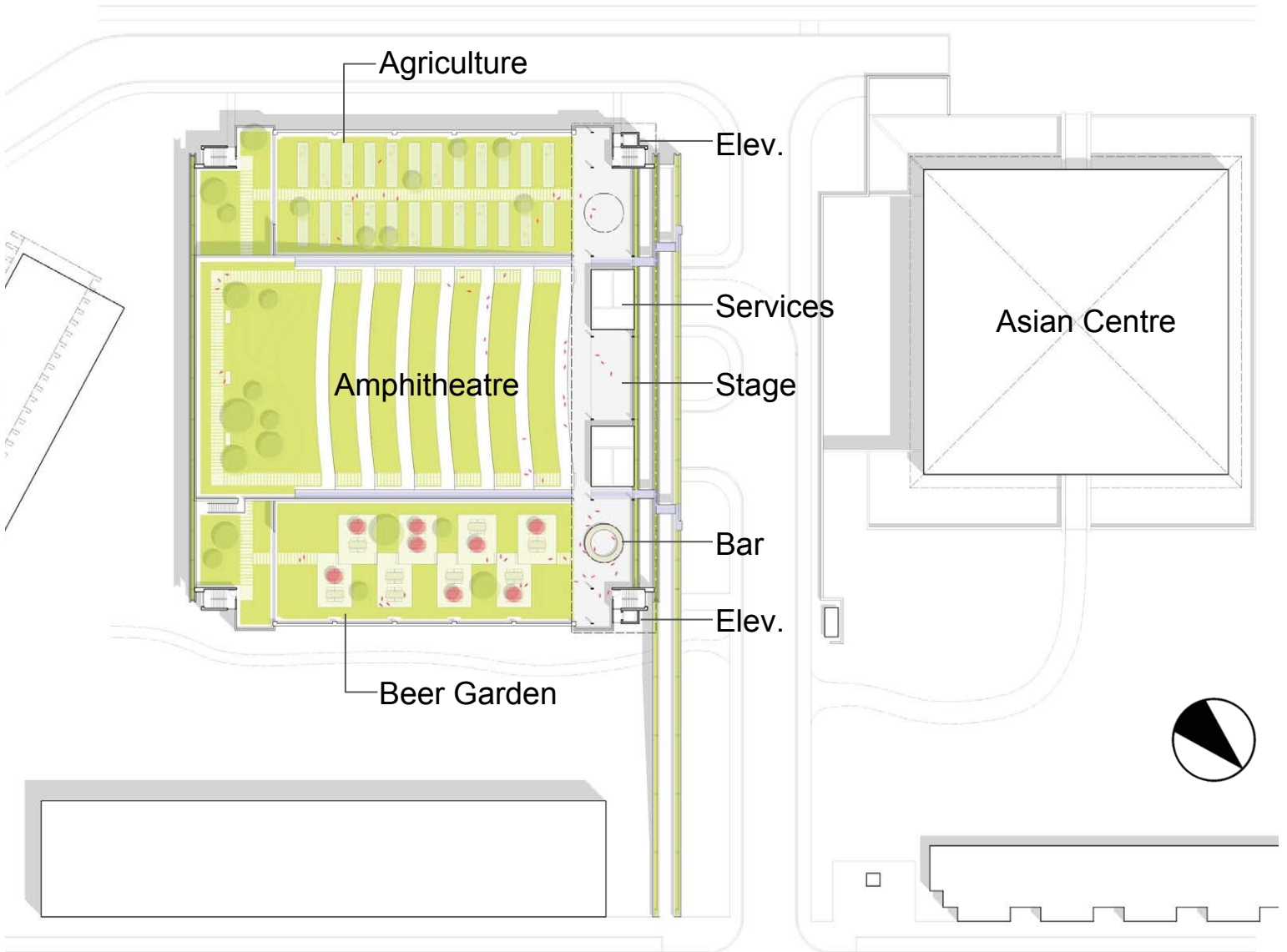

# Site Plan

Although only a small proportion of the site is available for rainwater mitigation, it is enough to make a considerable contribution. In fact, 1250m<sup>2</sup> of bioswales allows all runoff from 2 year rainstorm events to infiltrate on-site.

Because of existing constraints, including a property boundary to the south and a stand of mature trees to the east, the main bioswales must be slender and stream-like. The eastern bioswale is crossed-over by an existing pedestrian path, creating opportunities for landscape features like boardwalks and bridges. Integrating pathways and stormwater management also creates opportunities for public interaction and education.

Surrounding the Asian Centre are existing reflecting ponds. Rather than filling the ponds with potable water, runoff from the green roof at Fraser Parkade can be redirected and collected. At 550m<sup>3</sup> of storage capacity, the ponds provide more than enough water to irrigate the new green roof and landscaping. A feature can be made of the water-crossing at Memorial Road to attract public interest in UBC's stormwater management efforts.

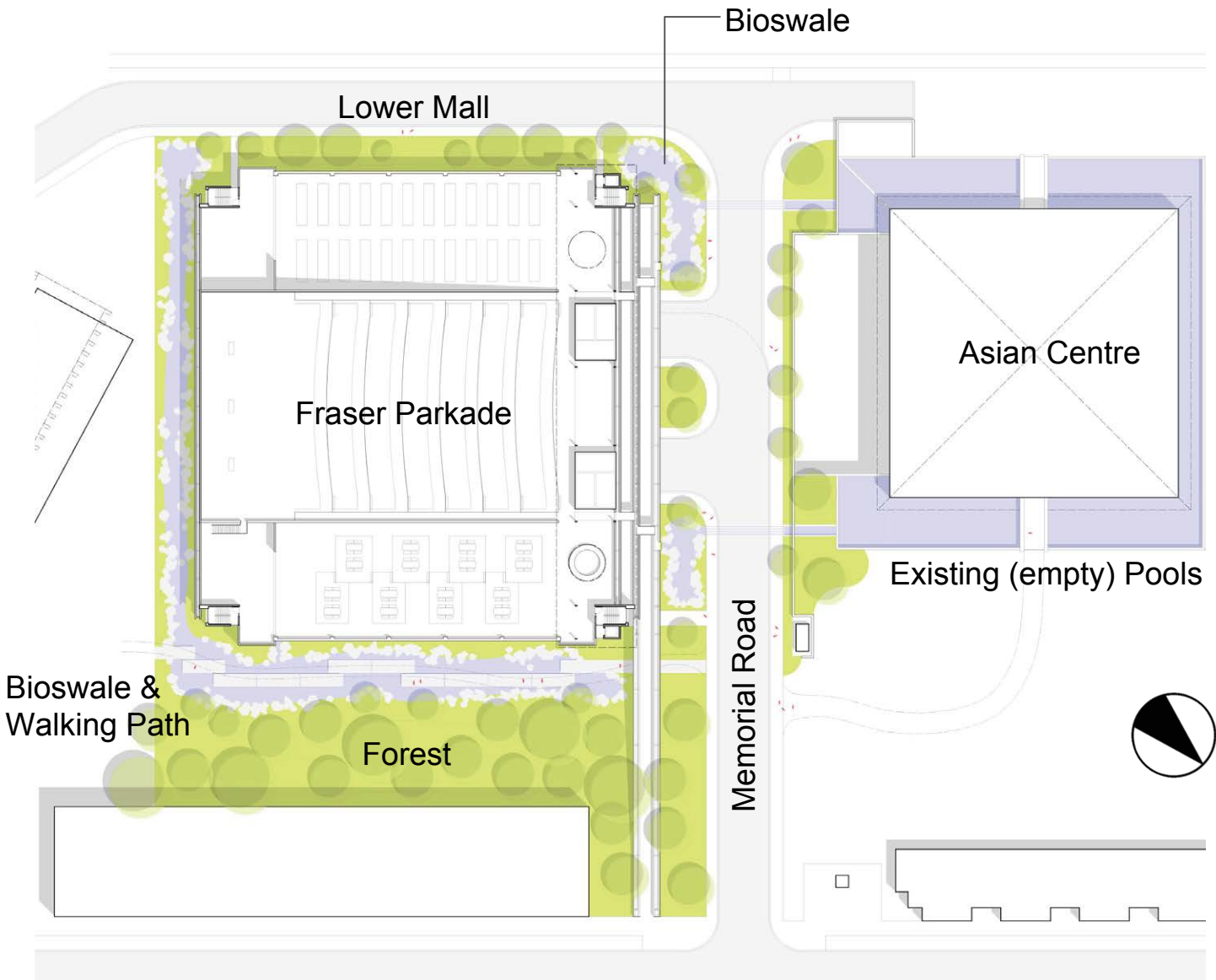



# Design Components

Because the roof slopes in two directions, rainwater runoff can be directed to the north and to the south. The central north-facing slope will send water to two bioswales adjacent to the parkade entry. From there, excess water can be directed to fill the Asian Centre reflecting ponds.

Each terrace on the parkade's north facade has a built-in concrete planter box. These existing (unused) planters may be incorporated into a cascading waterfall feature to draw attention to the green roof and to the stormwater mitigation system.

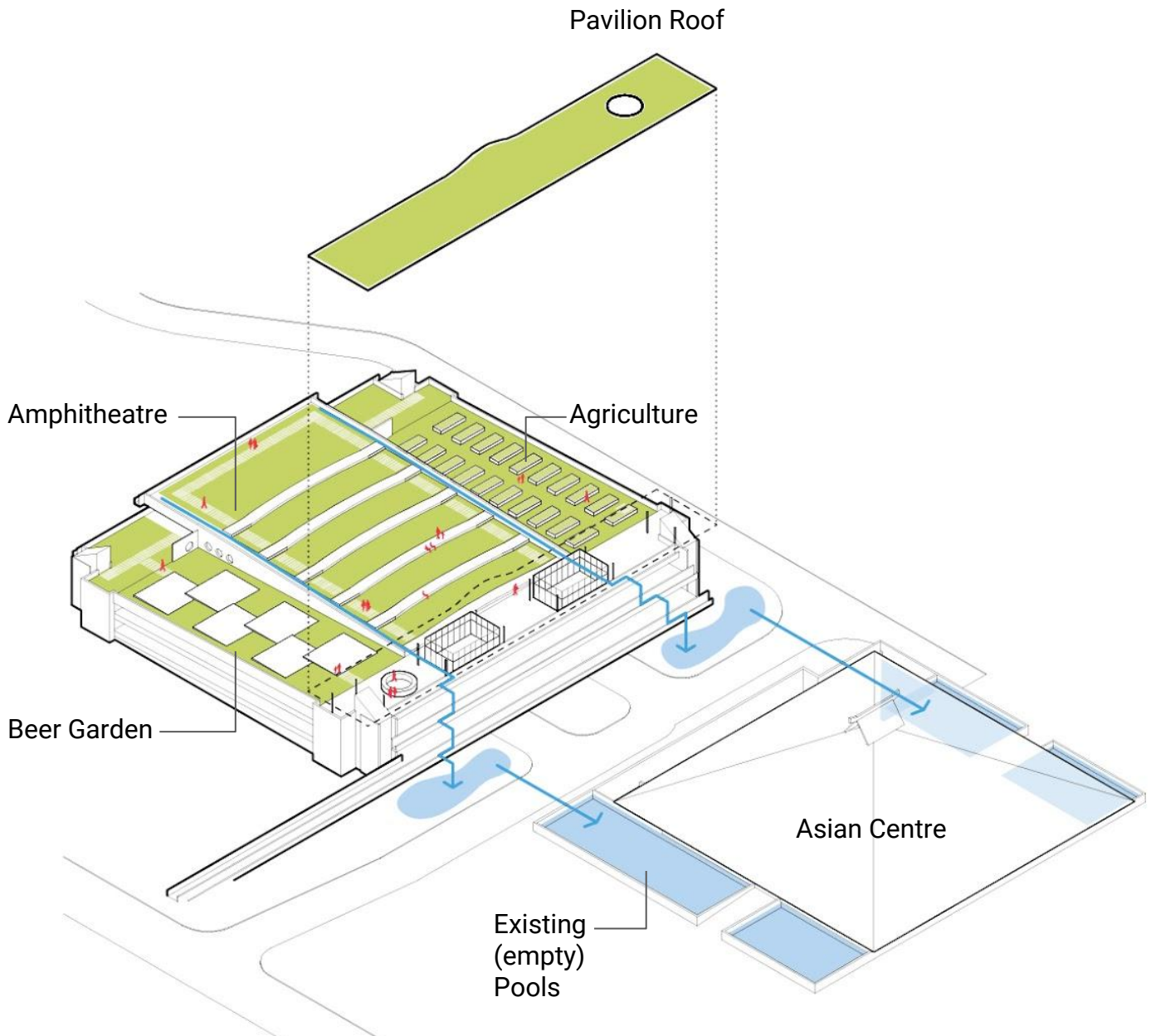



# Design Components

Rainwater from the two south-facing slopes is directed to the larger of the bioswales. This water can be mitigated entirely on-site, however some may be redirected to a cistern in the parkade's lower level. Cistern water can be used for flushing toilets and/or irrigation of the landscape and green roof.

The pavilion is constructed of steel and designed to sit lightly on the existing parkade structure. Atop the pavilion is an extensive green roof that, because it is not visible, can be planted with sedums and requires very little or no irrigation.

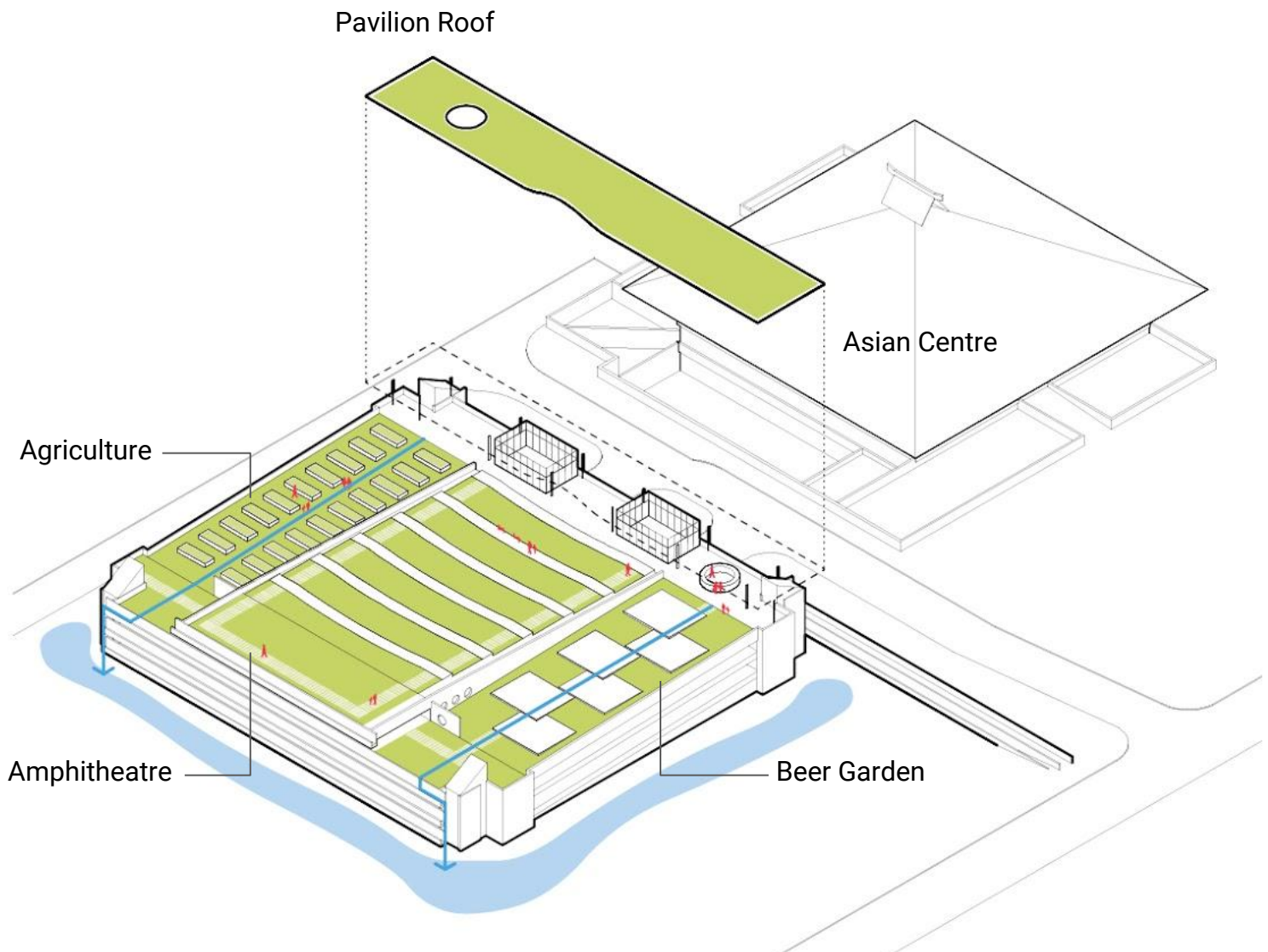

# Parkade Sections

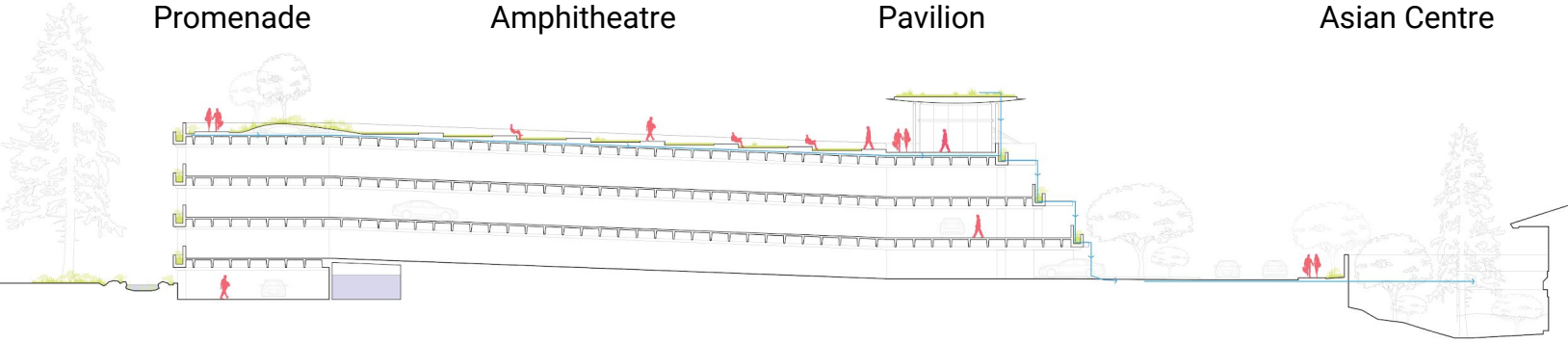

## North-South Section at Amphitheatre

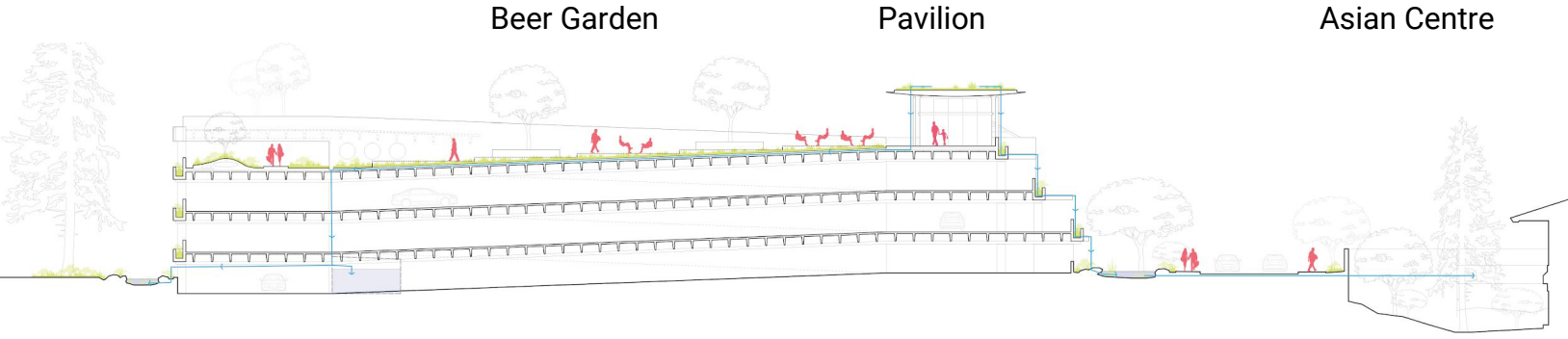

## North-South Section at Beer Garden

# Section Details

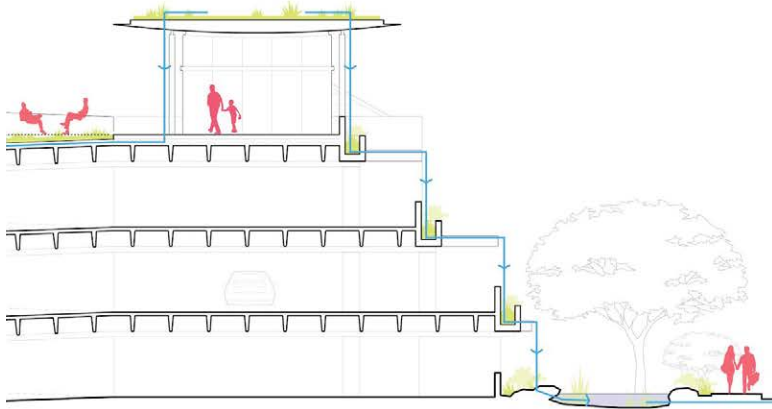

## Pavilion and Cascading Waterfall

The pavilion has a raised floor system to allow rainwater to flow under through designated channels. Existing concrete planter boxes at each north terrace, coupled with new rainwater scuppers, are used to make a feature out of how runoff reaches the bioswale.

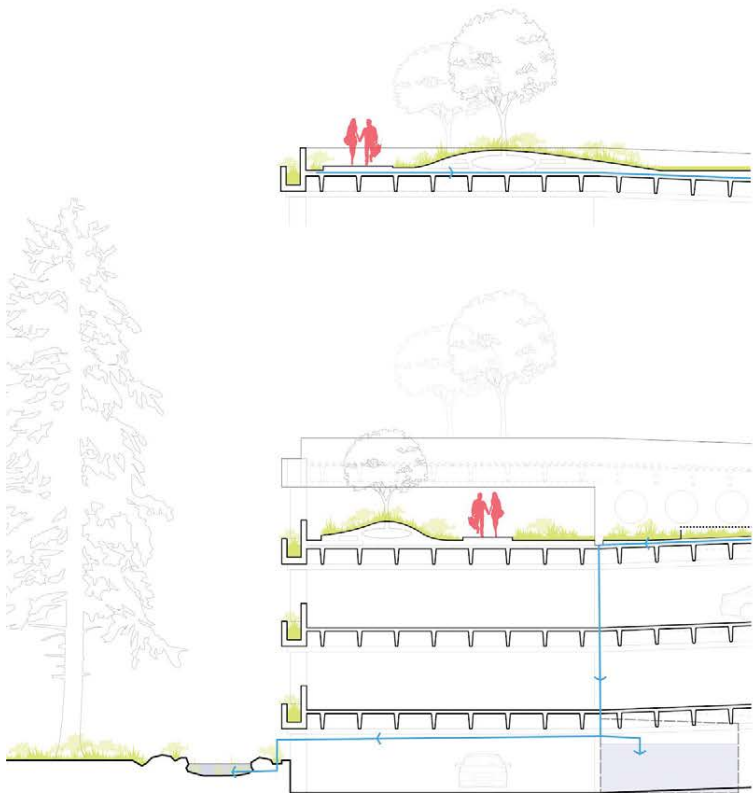

## Roof Topography

South of the amphitheatre, community garden and beer garden is a nominally flat area that can be used as a picnic lawn. To create interest, places for people to recline, and for planting large shrubs and small trees, the depth of growing medium can be increased. In zones where extra soil is not required for the plants, foam blocks can be used to create topography without adding weight to the roof.

# Roof & Catwalk Construction Details

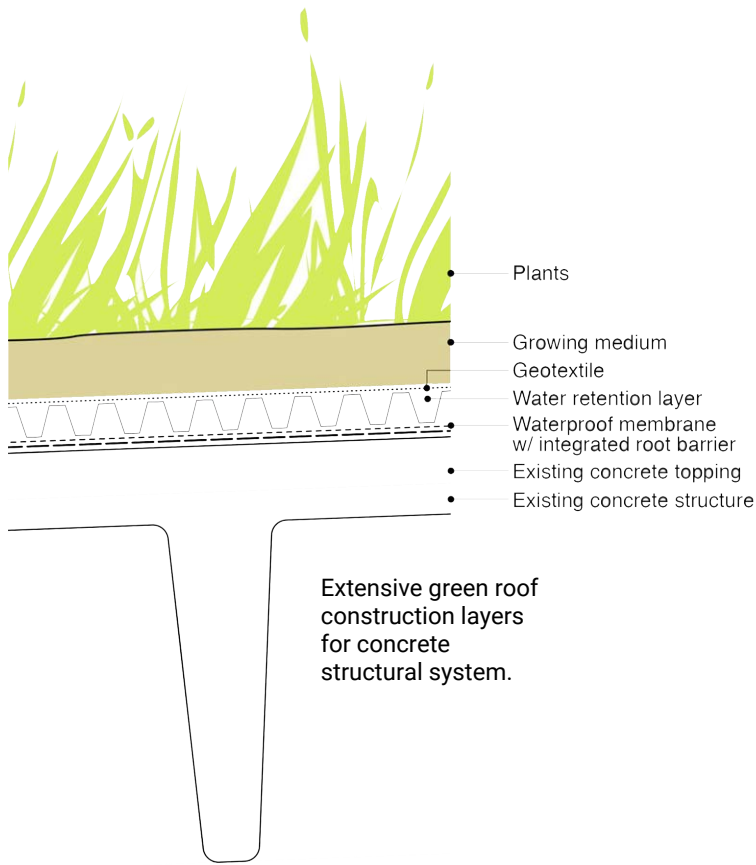

## Extensive Green Roof Layers

Given the structural loading conditions of the Fraser Parkade rooftop, weight was considered negligible. This allowed for both an intensive and extensive green roof to create a variety of conditions across the 4000 sqm roof. The illustration to the left shows the basic layering of an extensive green roof conversion. Growing medium depth and selected plants can alter based on a variety of functions that range from proposed urban agriculture and beer garden to tiered seating that can create music or performance venue space. While parking garages often lack rooftop systems special attention should be paid to any systems that do perforate the rooftop as this presents water infiltration problems with roofing membranes and can lead to system failures in the future.

## Catwalk System

To help maximize evapotranspiration effects as well as minimize human impact on green roof systems a metal catwalk system can be utilized to maintain plant life. Sedums that require minimal sunlight exposure can be used in this area to gain evapotranspiration benefits while still providing space for foot traffic. This system can also be used in the north east portion of the site where a current pedestrian path resides and the bioswale is proposed. This will allow for better use of site and water infiltration while maintaining student accessibility around the building. Any bridge like design would work for this purpose but the catwalk allows for sunlight exposure maximizing evapotranspiration while also allowing water and the coastal breeze to reach the plantlife.

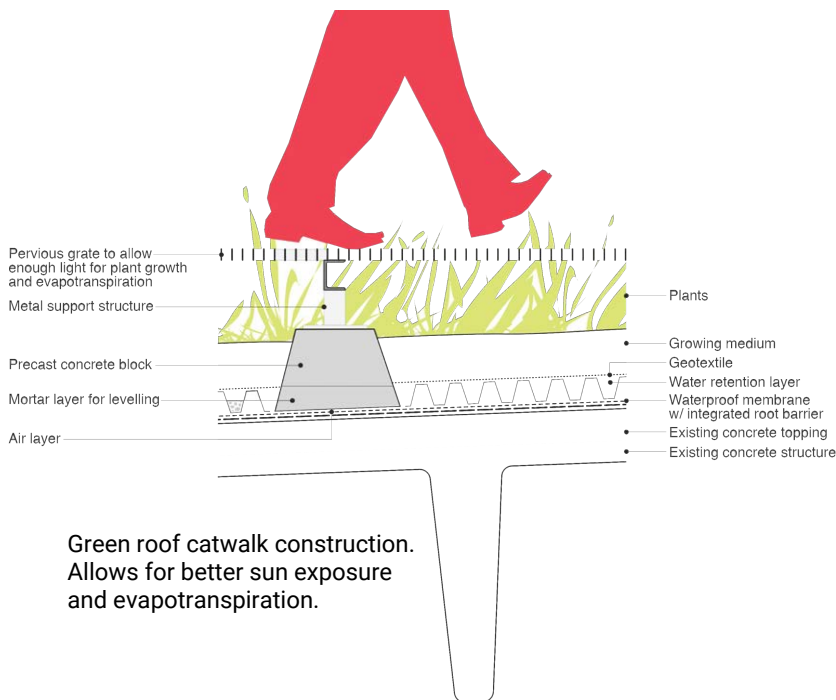

# Conclusion

Fraser parkade is often loaded under its maximum car capacity. Tucked away in the back corner of campus it's an excellent opportunity to explore green roof design and provide new spaces for student interaction and amenity.

The preliminary calculations and design show 100% water mitigation is possible on site through Low Impact Design systems. These strategies can be used all across campus to reduce water loads on the current stormwater management system. As UBC continues with new development it is crucial they think about dealing with stormwater on site through LID systems and subsequently provide ample space to deal with at a minimum 10 year storm events.

Given this sites particular relationship with the eroding edge of campus it makes for an interesting case study should the university continue to consider LID systems. Moving forward this location should be considered for soil studies and causes for the eroding edge as this will greatly affect LID systems in the area as well as give the university a better idea on how to deal with water mitigation in the future.

## Stepped Seating

At the amphitheatre seating and other roof features that require height, foam blocks can be used to fill space, reduce weight and protect the roof drainage layer. Rainwater is allowed to flow beneath such features, ensuring that the green roof continues to function without interruption.

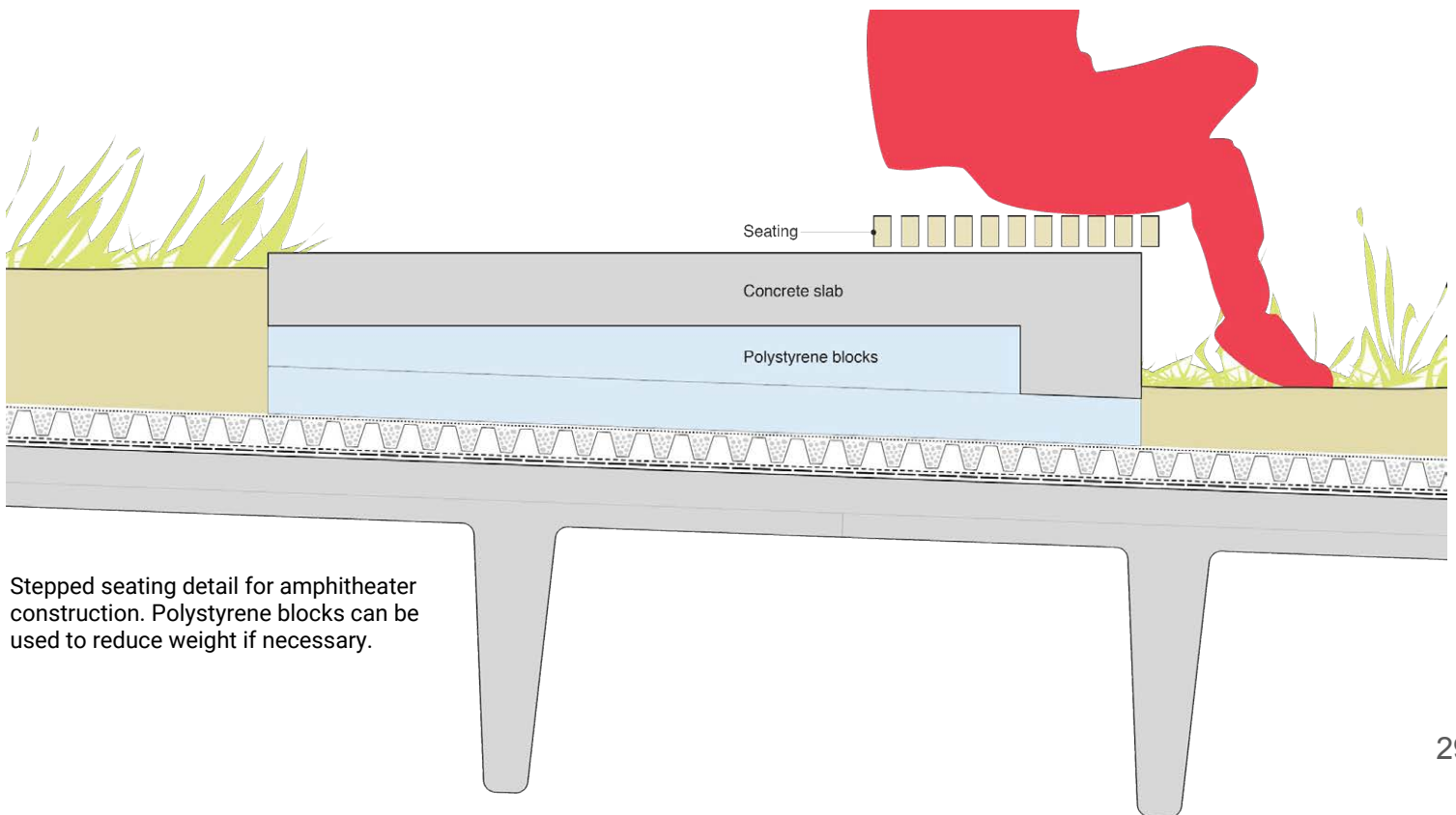

Stepped seating detail for amphitheater construction. Polystyrene blocks can be used to reduce weight if necessary.



# THUNDERBIRD PARKADE

Sara Duffin (M.Arch) Julia Lorimer (M.Larc)

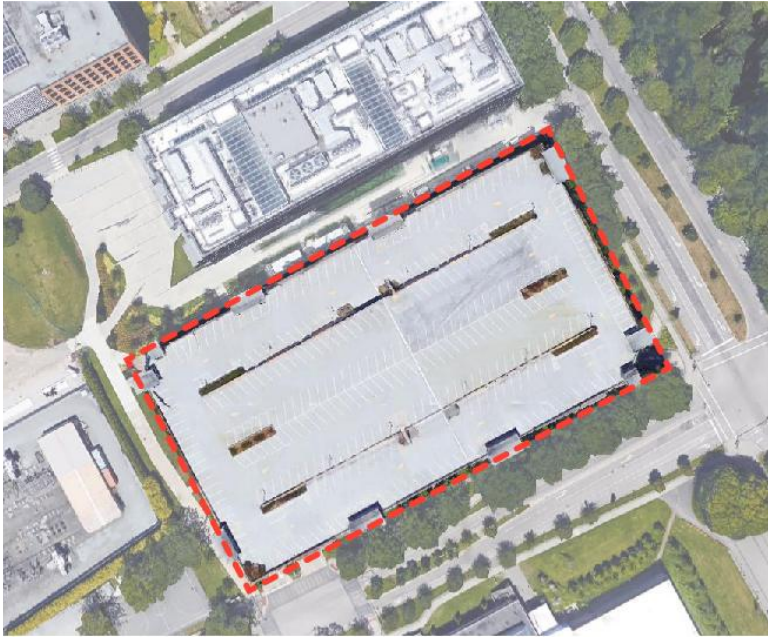

Thunderbird Parkade

Located on Thunderbird Boulevard & Wesbrook Mall, the Thunderbird Parkade is the largest parkade on campus with 5 floors of parking above grade and a half floor below. The parkade roof gets daylight all day and has great views of the islands to the west and mountains to the north. The building footprint and roof area are approximately 9765m<sup>2</sup> and the structure is surrounded by mature trees to the east and south sides. Notably, this parkade is very close to the Doug Mitchell Thunderbird Sports Centre making it an ideal candidate for a rooftop social space and breakout area for events held at the Sports Centre.

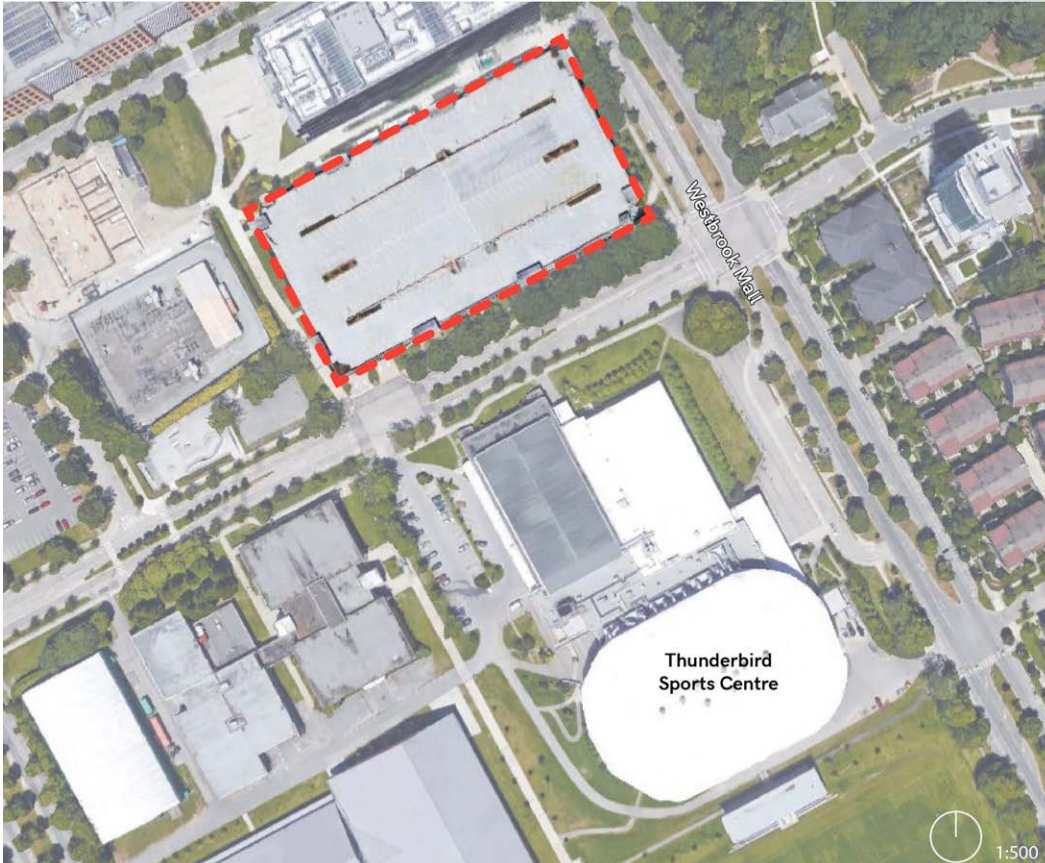

Thunderbird Parkade aerial map

# Thunderbird Parkade

## Adjacencies

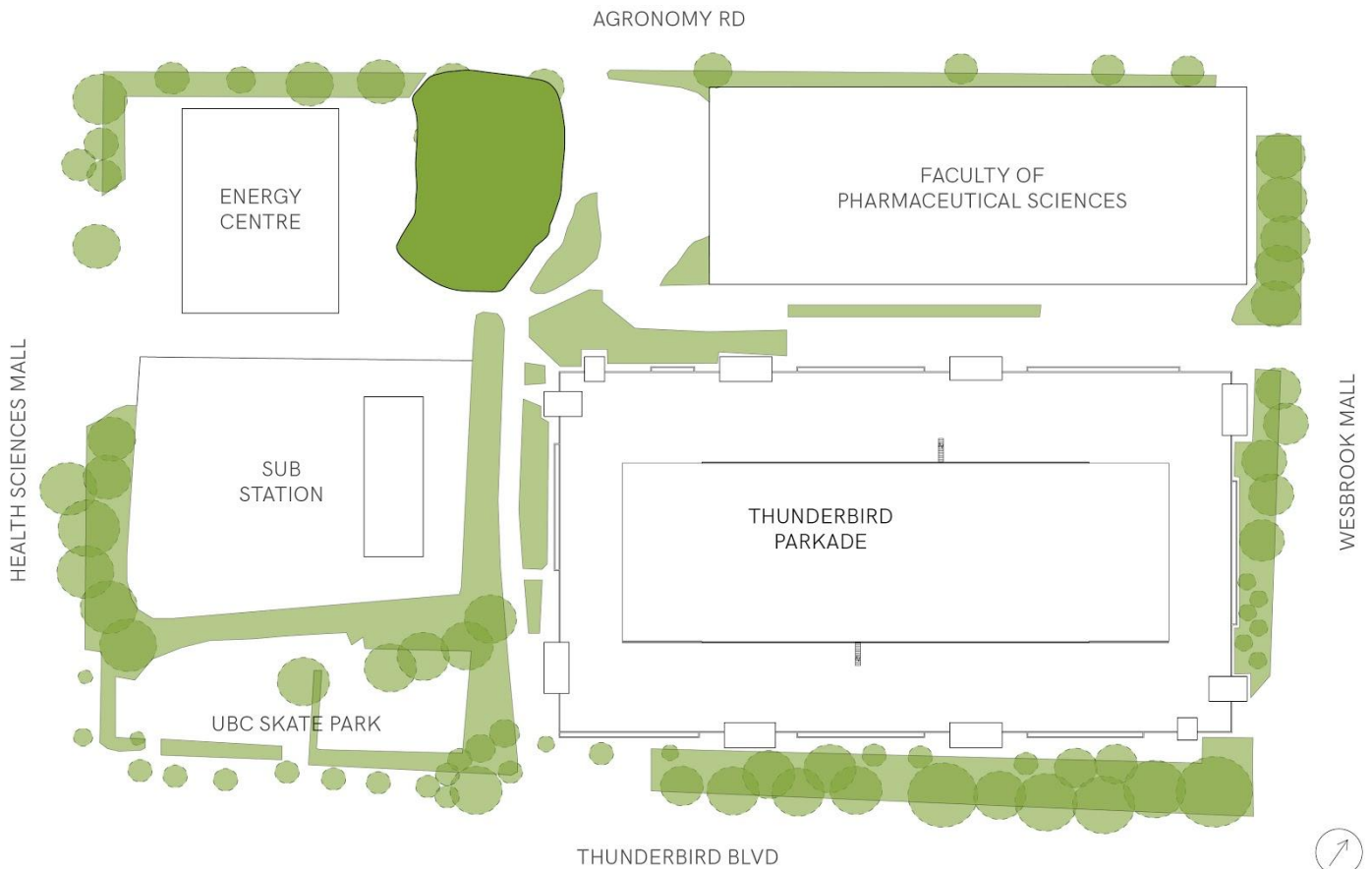

The parkade is adjacent to the UBC skatepark, the substation and the energy centre to the west, the Faculty of Pharmaceutical Sciences building to the north, residences to the east and the Doug Mitchell Thunderbird Sports Centre to the south.

# Thunderbird Parkade

## Views

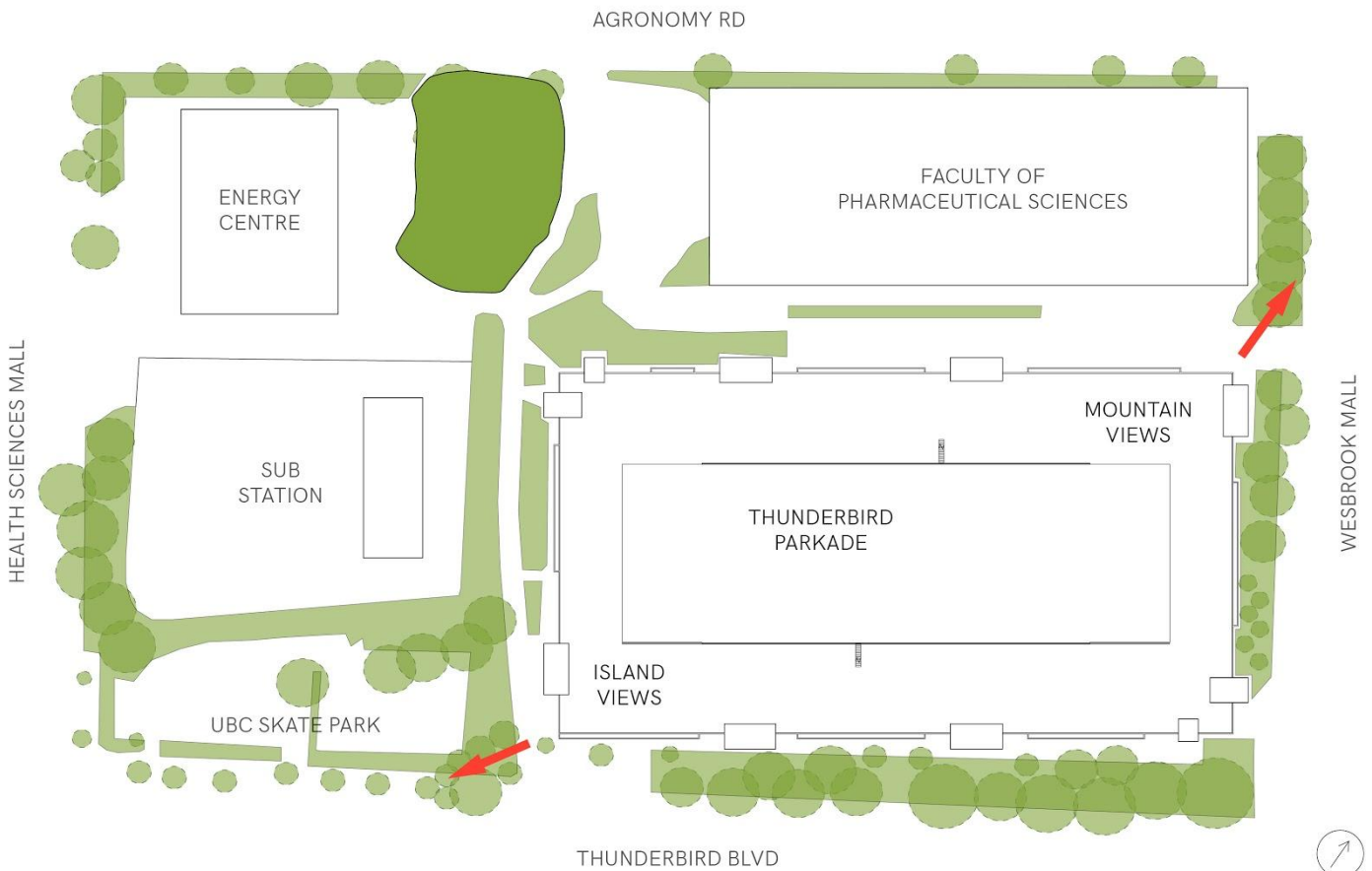

Being in an area of lower rise buildings, the views from the roof of the parkade are unobstructed and at present, only drivers who park their cars on this rooftop get to take advantage of these views.



# Thunderbird Parkade

## Condition



Surprisingly, the roof already has some green roof installed but the drainage of these systems is unknown. The parkade also shows signs that it is in disrepair and drainage is not functioning properly with many of the drains being clogged with soil, growing plants and garbage.

# Thunderbird Parkade

## Extensive Green Roof

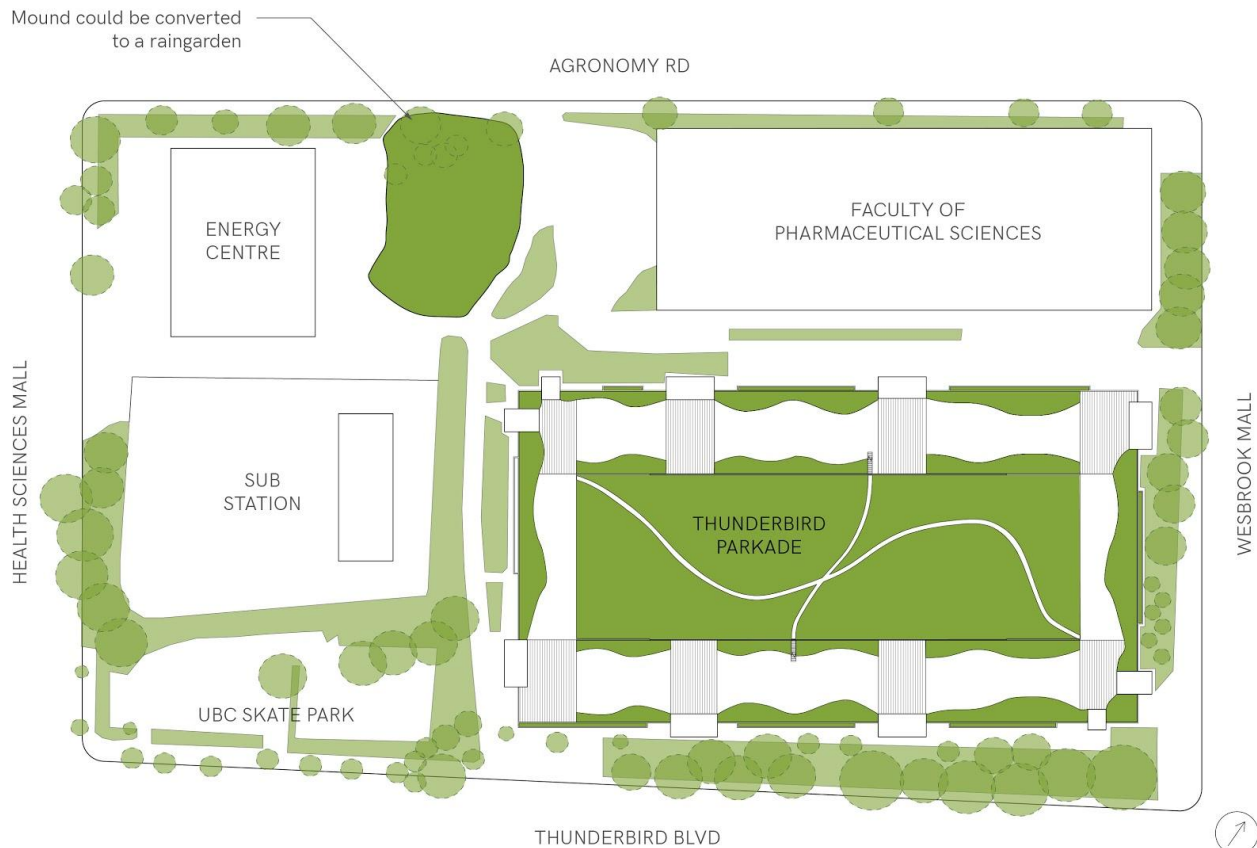

**Total Roof Area:** 9765m<sup>2</sup>

**Green Roof:** 5547m<sup>2</sup>

**Raingarden:** 1420m<sup>2</sup>

= 54% mitigation

Considering the size of this space, the green roof condition here could be quite substantial. In our calculations, if 5547m<sup>2</sup> of greenroof were to be installed with an at grade raingarden of 1420m<sup>2</sup>, stormwater runoff could be mitigated by 54%. As long as they are approved to be in working order, the areas of existing greenroof could continue to be used.

As seen above, an earlier version of this design had a nearby mound being converted into a raingarden but this was deemed not possible as many utilities converge under this mound. The area of 1420m<sup>2</sup> could be made up elsewhere where mature trees do not interfere.



# Thunderbird Parkade

## Extensive Green Roof

**Total Roof Area: 9765m<sup>2</sup>**

**Green Roof: 5547m<sup>2</sup>**

**Raingarden: 1420m<sup>2</sup>**

**= 54% mitigation**

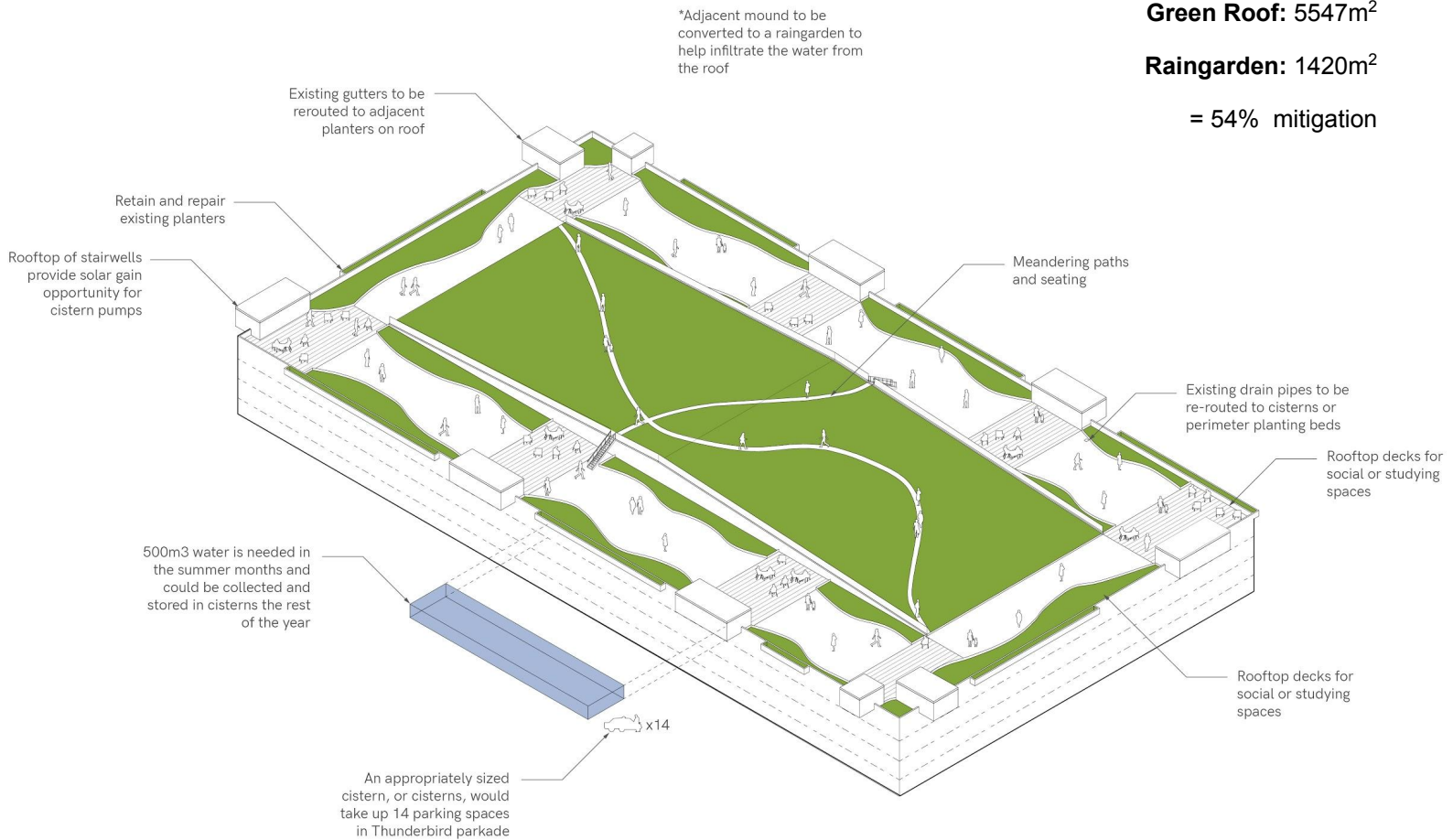

### 14 parking spot cisterns

= 61% mitigation

### 103 parking spot cisterns

= 100% mitigation

In a green roof scenario of this size and using sedum as its main plant, the irrigation requirements over July and August would be approximately 500m<sup>3</sup>. If two meter high cisterns were to take up 14 parking spots in the Thunderbird parking lot, this amount of water could be collected during the rainy months and stored for the summer. This scenario would see an increase to 61% stormwater mitigation and the benefit of not using potable water for irrigation.

For comparison's sake, if the goal was to reach 100% mitigation, the space of 103 parking spots would need to be used for cisterns but much of this water could be piped elsewhere for irrigation purposes.



# WEST PARKADE

Pauline Moskal, MLA | Lisa Ng, MLA

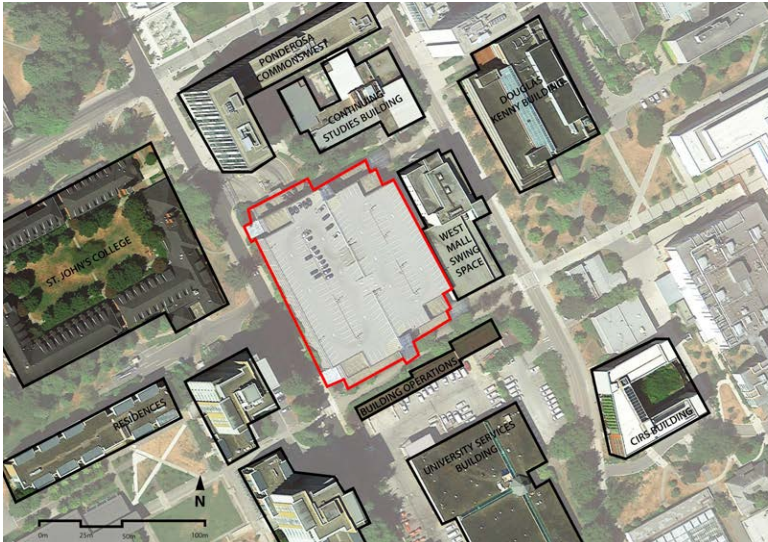

West Parkade, adjacent buildings

West Parkade is located along Lower Mall, between University Boulevard and Agronomy Road. Because of the split level design, the parkade technically has 12 floors. There is no elevator access to this parkade.

This parkade has some unique features that makes it a potential site for social gatherings. Towards the southwest, there are a number of student residences and towards the northeast, it is surrounded by institutional buildings; this guarantees high pedestrian traffic throughout the day. There are views towards the mountain and water at various points on the top floor. The building is also visible from 10 other buildings on campus.

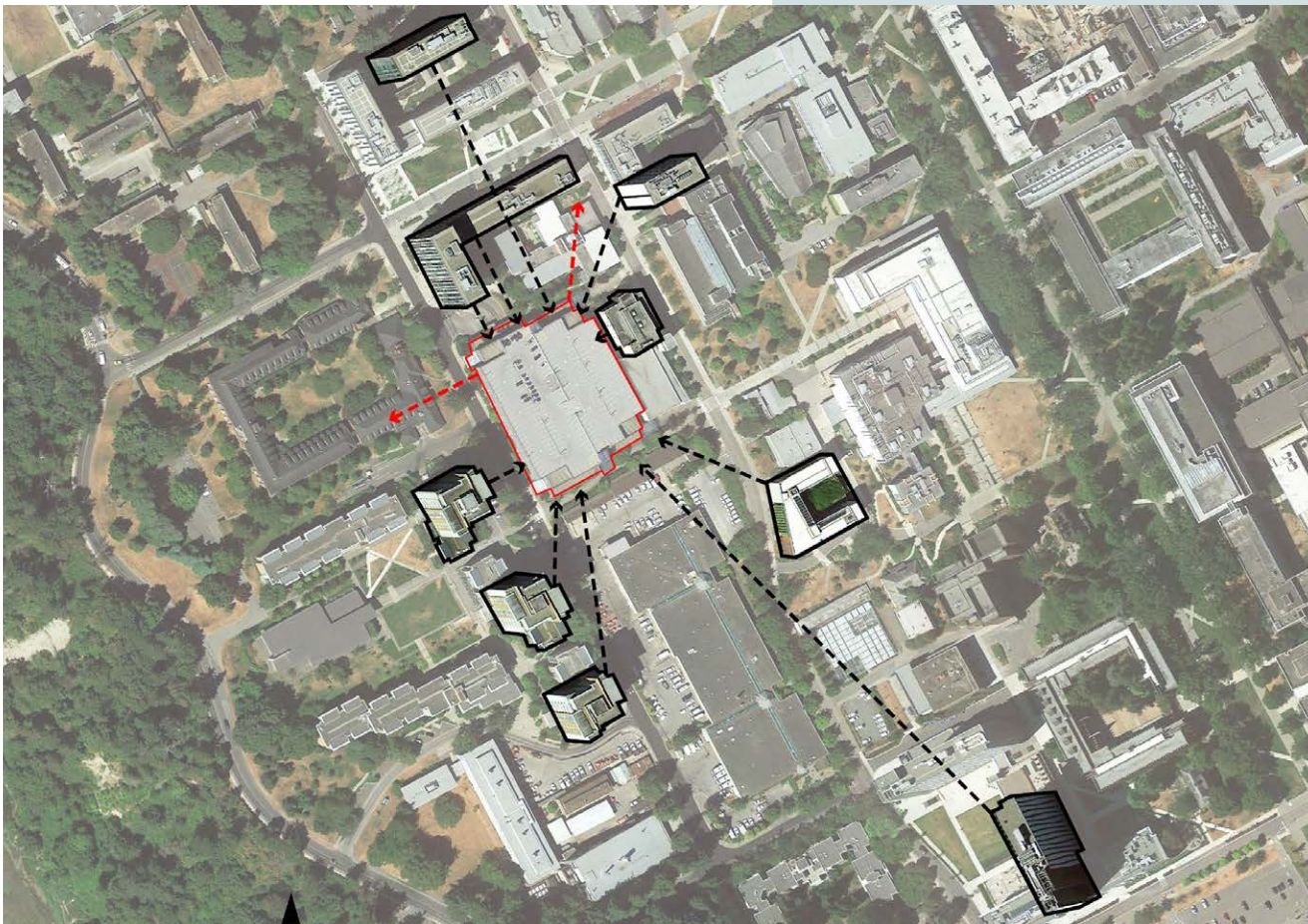

West Parkade, aerial map showing building with views onto the roof



# West Parkade

## Existing Conditions



View towards north



Drain locations



View towards southwest

# West Parkade

## Option 1: Intensive Roof with Cisterns

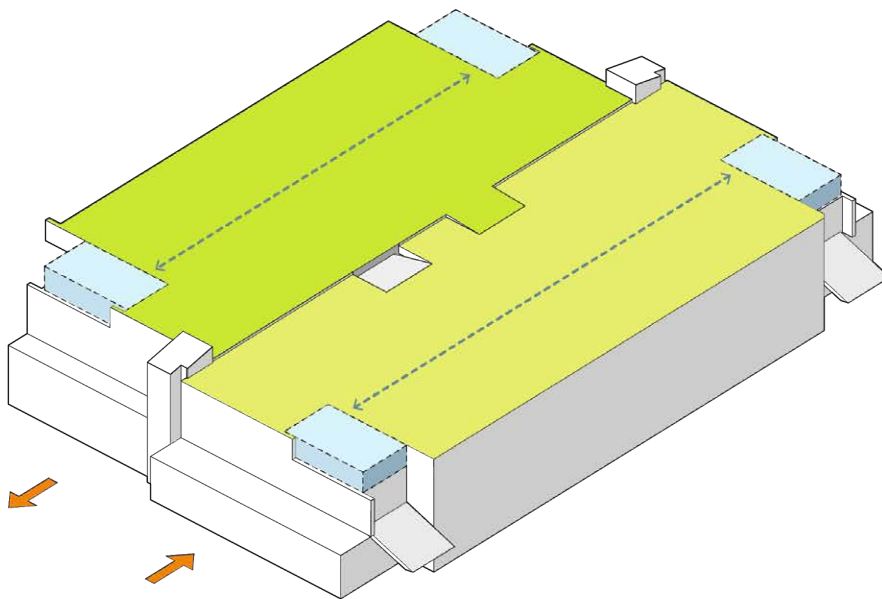

**Total Roof Area:** 4878m<sup>2</sup>

**Total Precipitation:** 1222mm

68% mitigated on roof

32% stored in cisterns

---

= 100% mitigation

\*cisterns replace additional 20 parking spaces

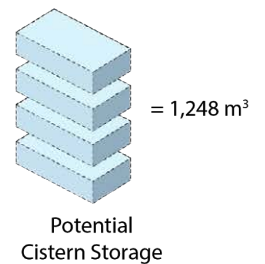
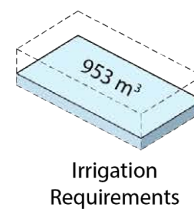
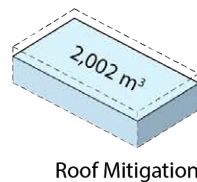
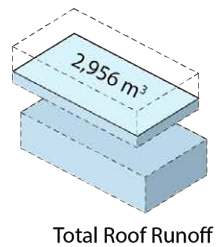
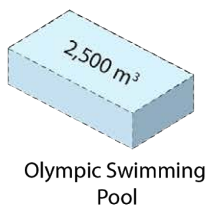

# West Parkade

## Option 2: Intensive Roof

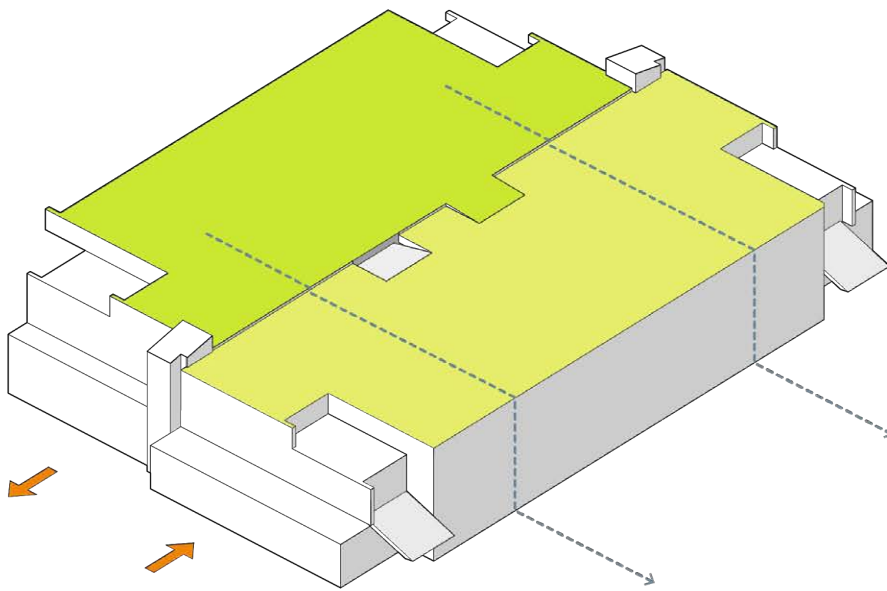

Total Roof Area: 4878m<sup>2</sup>

Total Precipitation: 1222mm

---

68% mitigated on roof

32% piped to storm main

= 68% mitigation

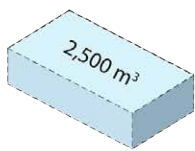

Olympic Swimming Pool

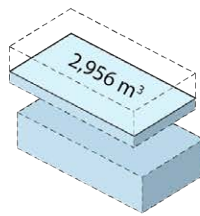

Total Roof Runoff

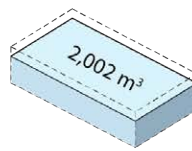

Roof Mitigation

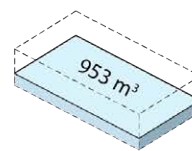

Diverted to City



# West Parkade

## Option 3: Half Intensive Roof

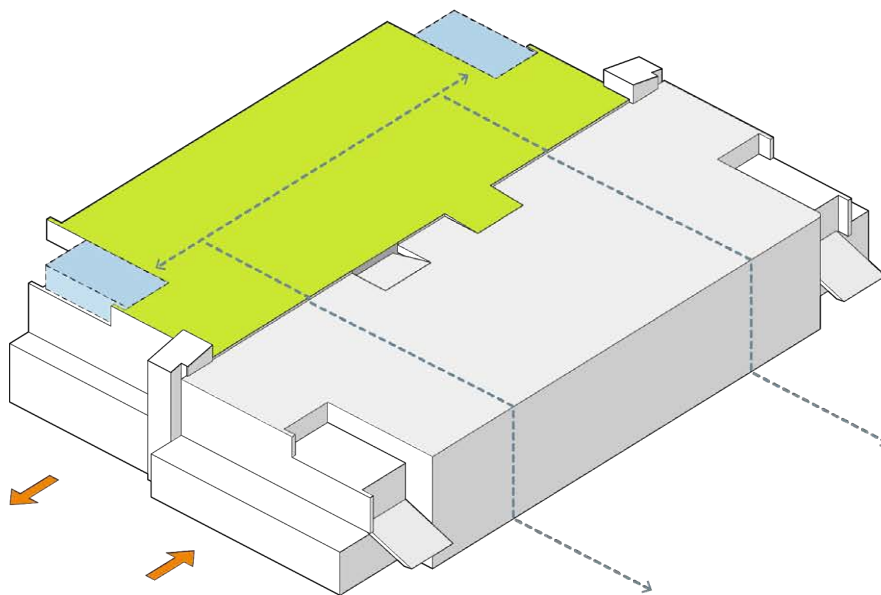

Total Roof Area: 2248m<sup>2</sup>

Total Precipitation: 1222mm

68% mitigated on roof

32% stored in cisterns

= 46% total runoff mitigation

\*cisterns replace additional 10 parking spaces

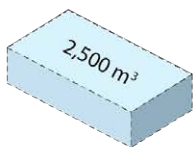

Olympic Swimming Pool

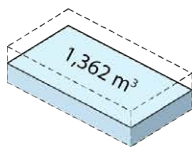

Total Roof Runoff

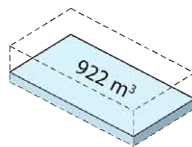

Roof Mitigation

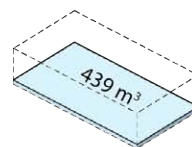

Irrigation Requirements

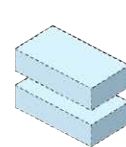

Potential Cistern Storage = 624 m<sup>3</sup>

# West Parkade

## Possible Site Programming

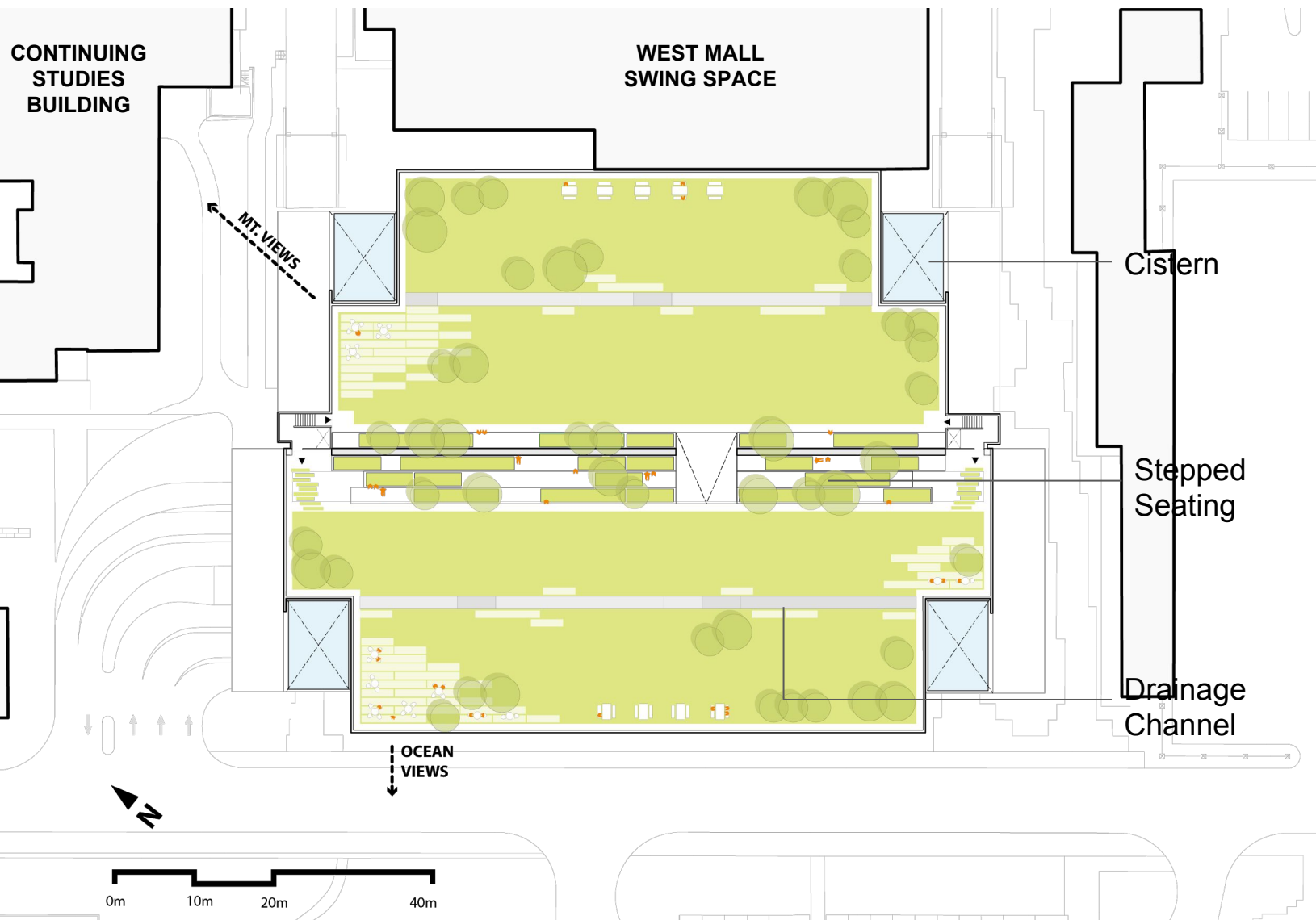

LOWER MALL

# West Parkade

## Section

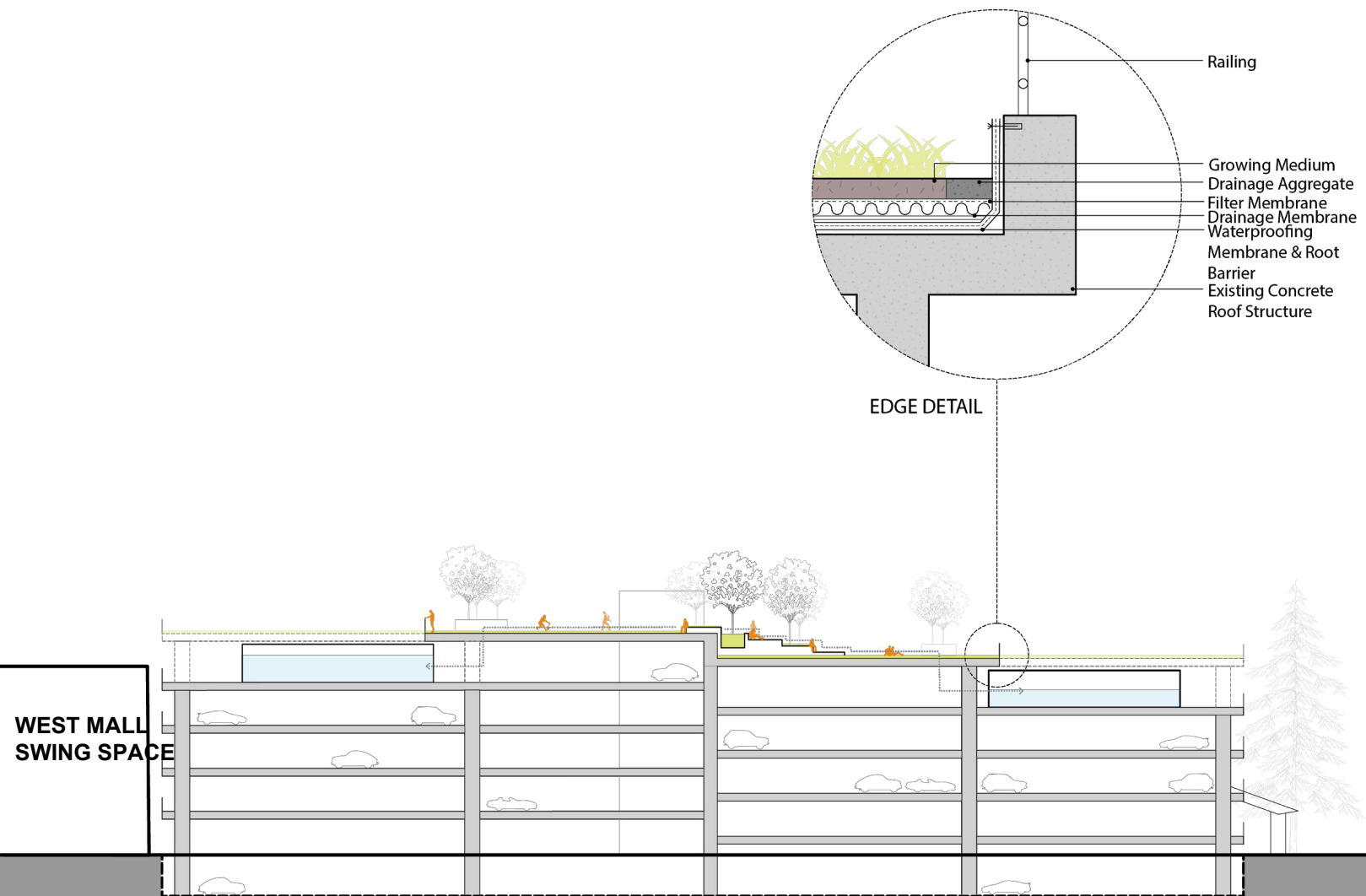

# West Parkade





# NORTH PARKADE

Samaneh Gharehdaghi MLA | Jaldhi Gohil MUD



Fraser Parkade; Built 1980's

North Parkade lies between the Walter Gage road and the Student Union Blvd in the University of British Columbia. North Parkade is surrounded by student residential buildings- Brook commons tallwood house and Walter Gage. It has four floors above ground and one underground. The parkade covers area of 5740 sq mts. The parkade is accessible on all floors by stairs. There is existing green space adjacent to the parkade. For the green roof study, two options were studied. The first option looks at the roof half being converted into extensive and half into intensive green roof and second parts of the roof converted to green roof.



Fraser Parkade aerial map



# North Parkade

## Site Photos



Existing drainage



Terrace of the parkade



Stairs at each floor



Panoramic view showing the surrounding residential buildings



On-ground parking



Green space beside parkade



Surrounding green space

# North Parkade

## Option 1 Converting half of the roof to intensive, half to extensive

Total Roof Area: 5740 m<sup>2</sup>

7.81 % mitigated on roof

14.51 % piped to storm main

---

77.68% mitigated via rain garden

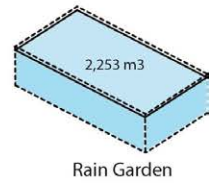
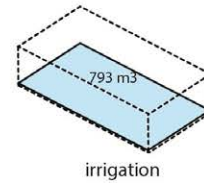
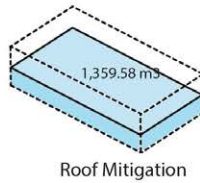
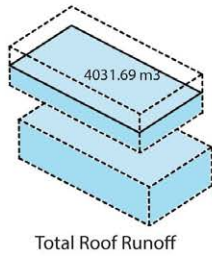
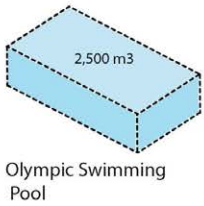
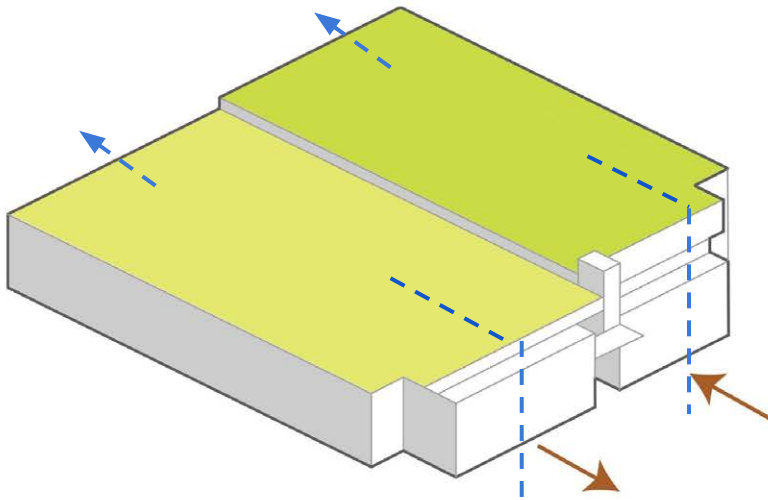

## Option 2 : Converting half of the roof to extensive roof

Total Roof Area: 5740 m<sup>2</sup>

2.93 % mitigated on roof

19.9% piped to storm mains

---

77.17 % mitigated via rain garden

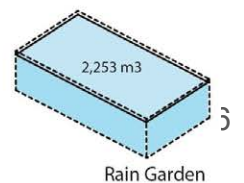
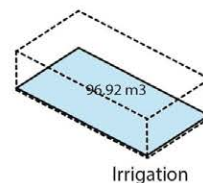
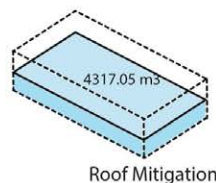
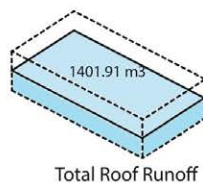
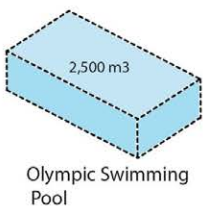
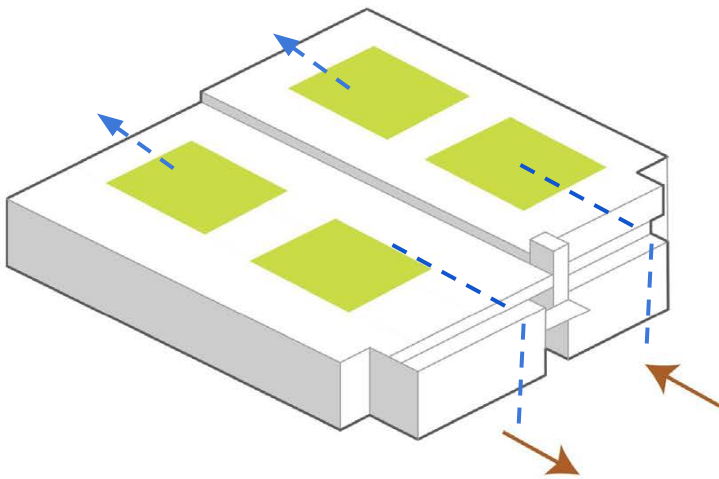

# North Parkade

After looking at both the option, we selected the second to use some of roof as green roof and some as parkade. In near future, turning the whole roof as a green roof could be seen as a proposal as green roof are efficient in reducing the runoff rate.

Using the existing green spaces as rain garden, it would help to mitigate the roof runoff water. The roof is designed with a canal passing in between and providing a seating space for people.

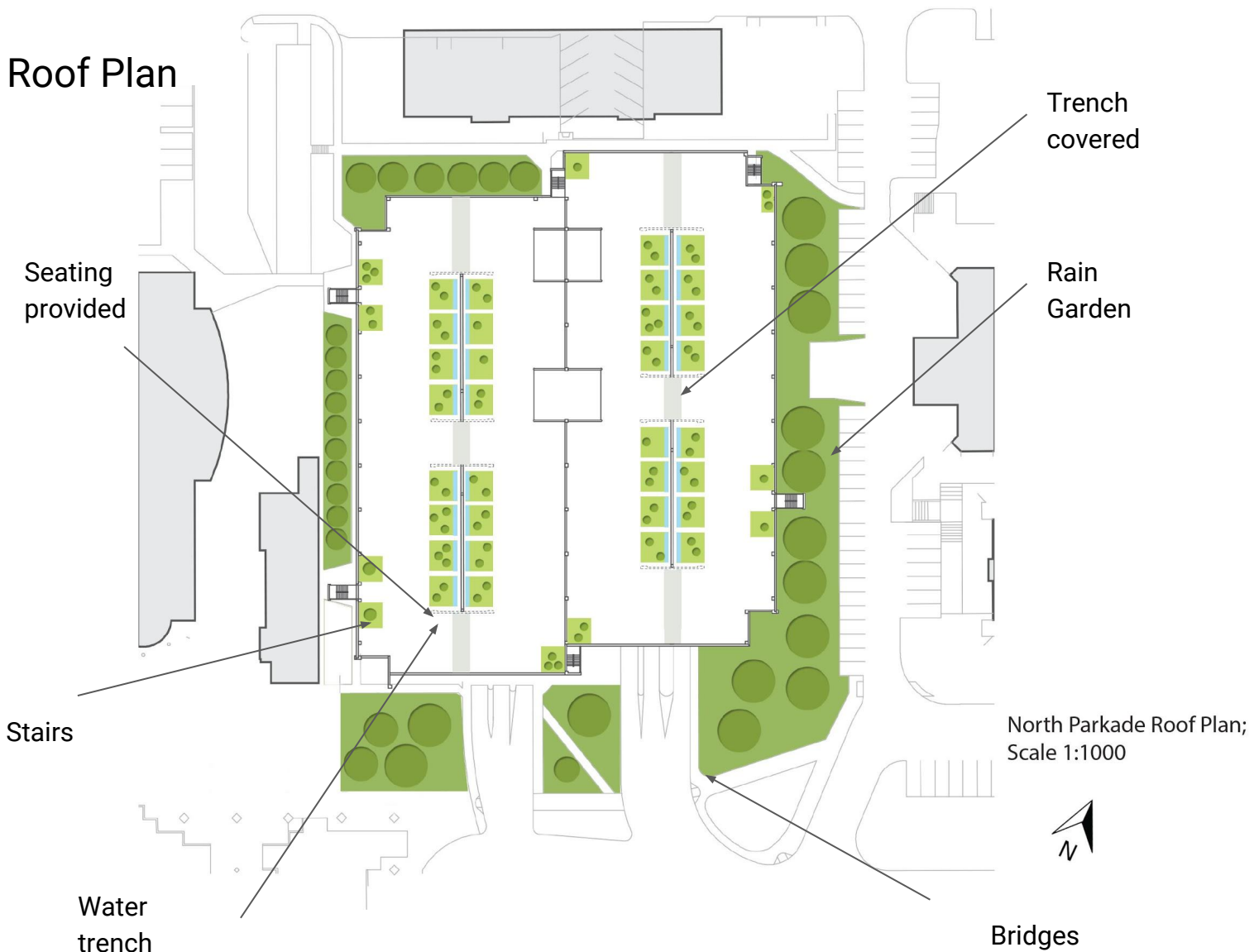



# North Parkade

Plants like Sedum, Sempervium and moss are some of the good choices to be planted on the roof which does not need much maintenance and are helpful to slow down the rate of water flow on the roof.



moss



Sedum



Sempervivum

## Water flow diagram

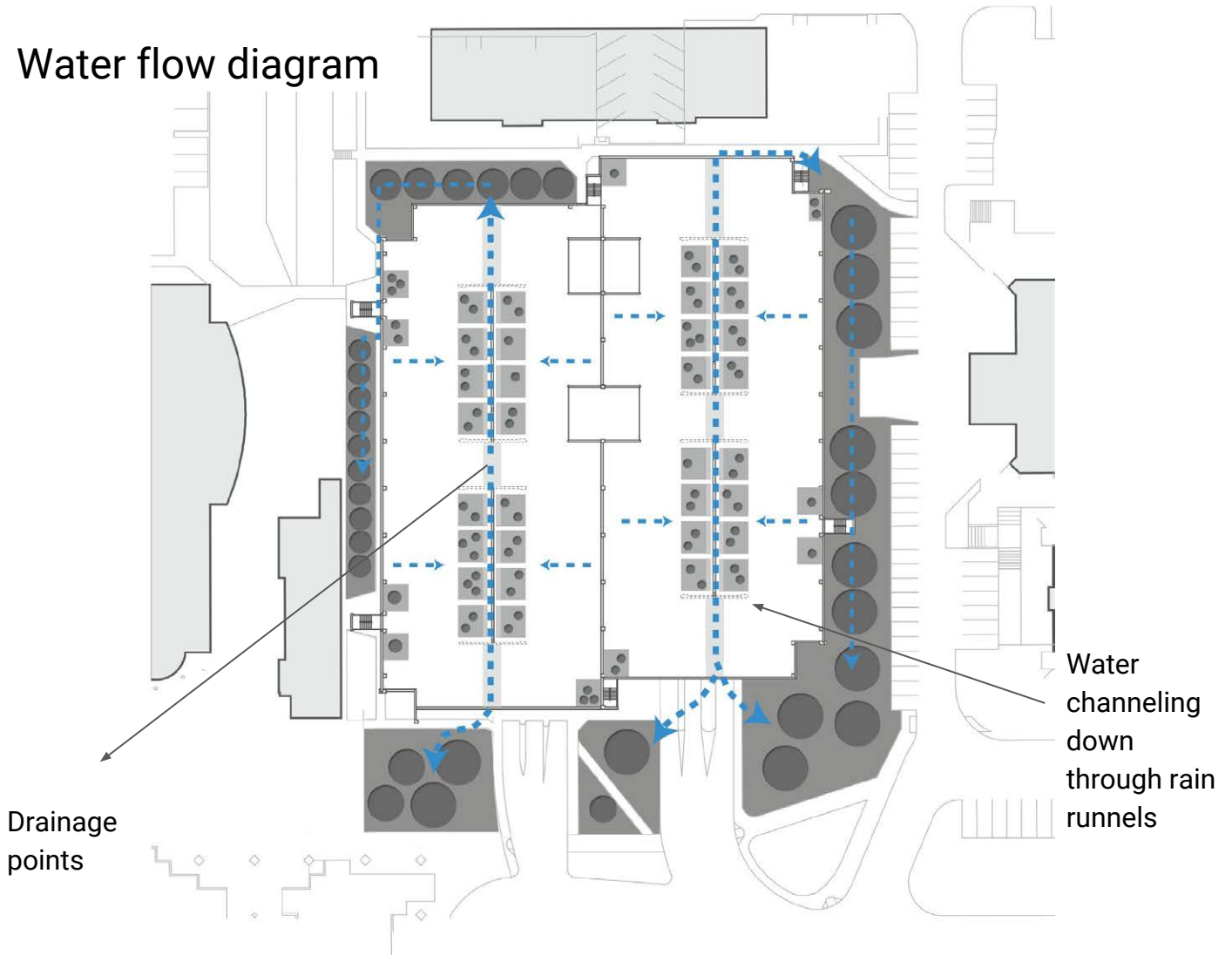

Working with the existing water flow system, the water on the roof would be directed by rain runnels into the rain garden near the parkade. This would be useful to use the extra rain water and water the green spaces nearby.

# North Parkade

## Site Section

Constructing green roof on the parkade, would serve a lot of purposes, such as absorbing the rain water, providing a green space for the residence living nearby, decreasing stress of the people around by providing a more aesthetically pleasing landscape, a place for the biodiversity and many more.

Rain Runnel

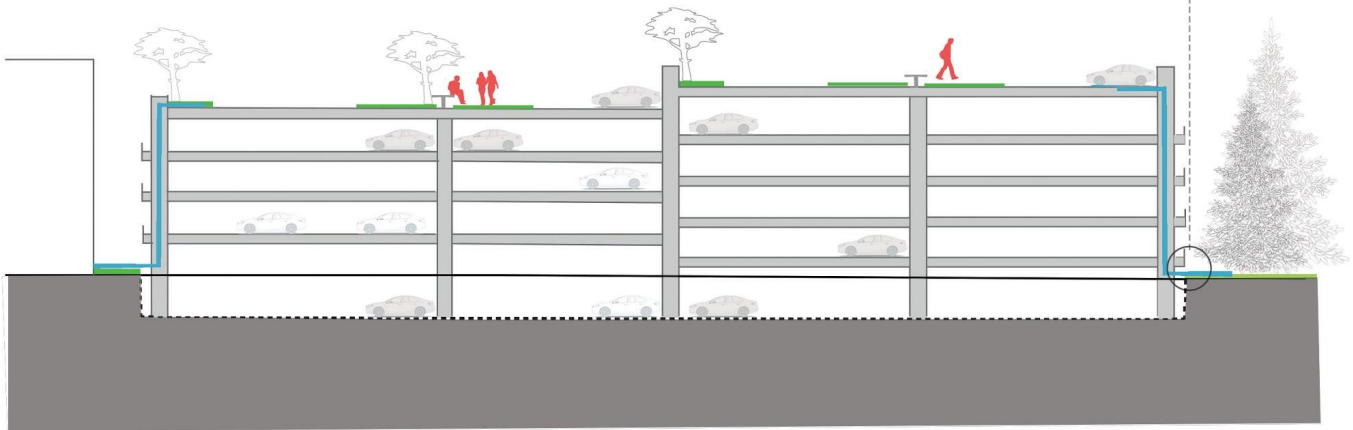
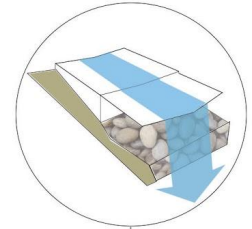



# STADIUM NEIGHBORHOOD

Derek Landon Wong (M.Arch), Jan Louis Rodriguez (M.Arch),  
Elnaz Moftehkhari (M.Arch)

New residential neighbourhood with mixed use buildings near East Mall and 16th Ave

Public consultation launched fall 2017 (no decisions made yet)

Buildings would likely be on the scale of 6-22 stories



Stadium Neighbourhood Aerial Map

# Schematic Options

PFS Studio

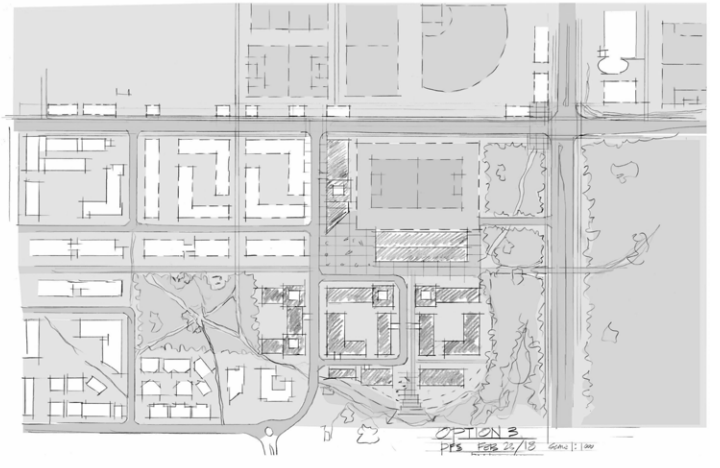
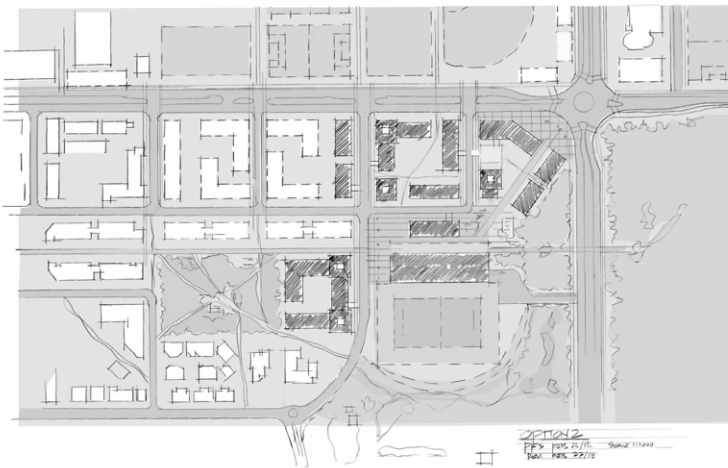
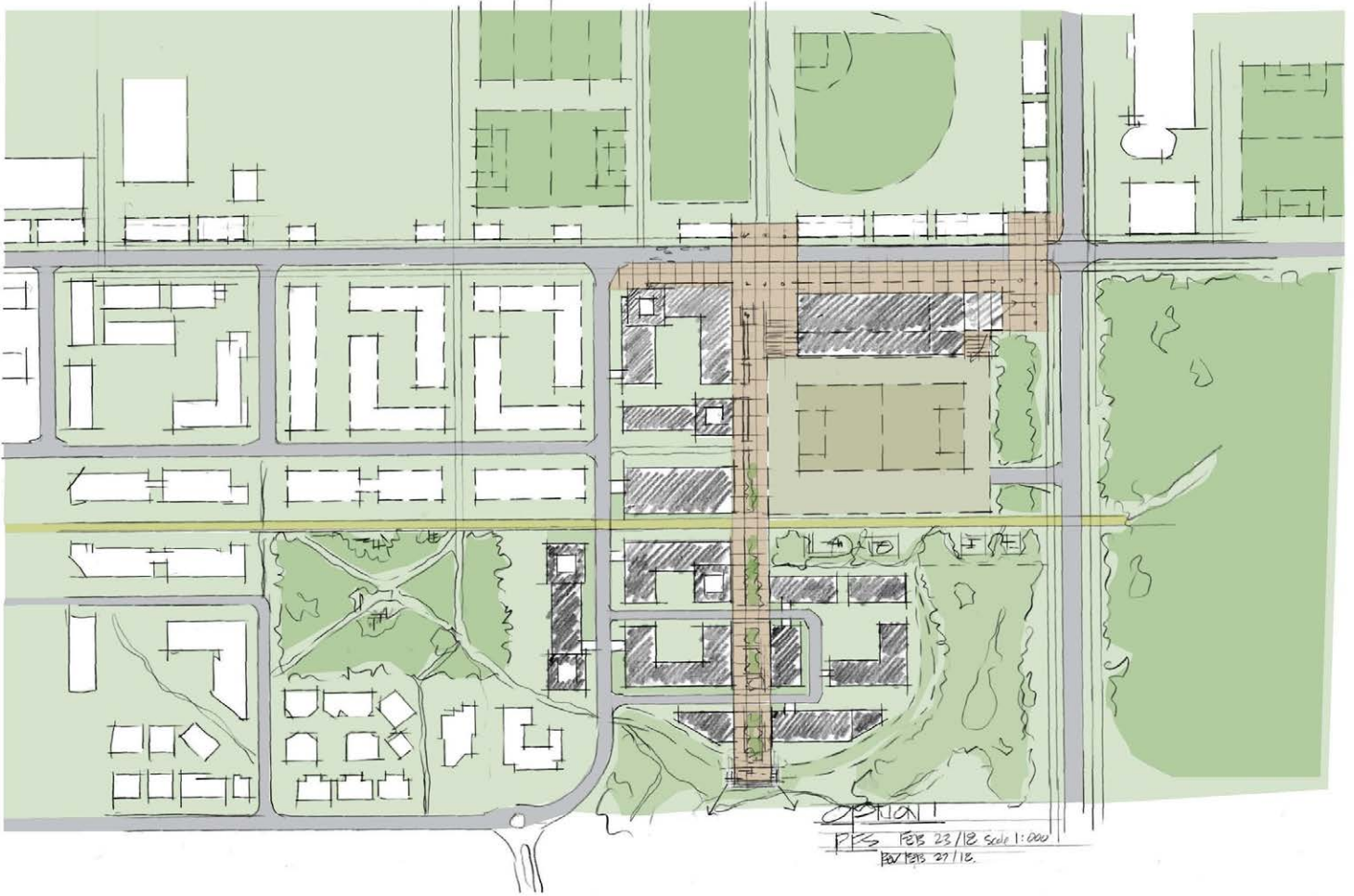





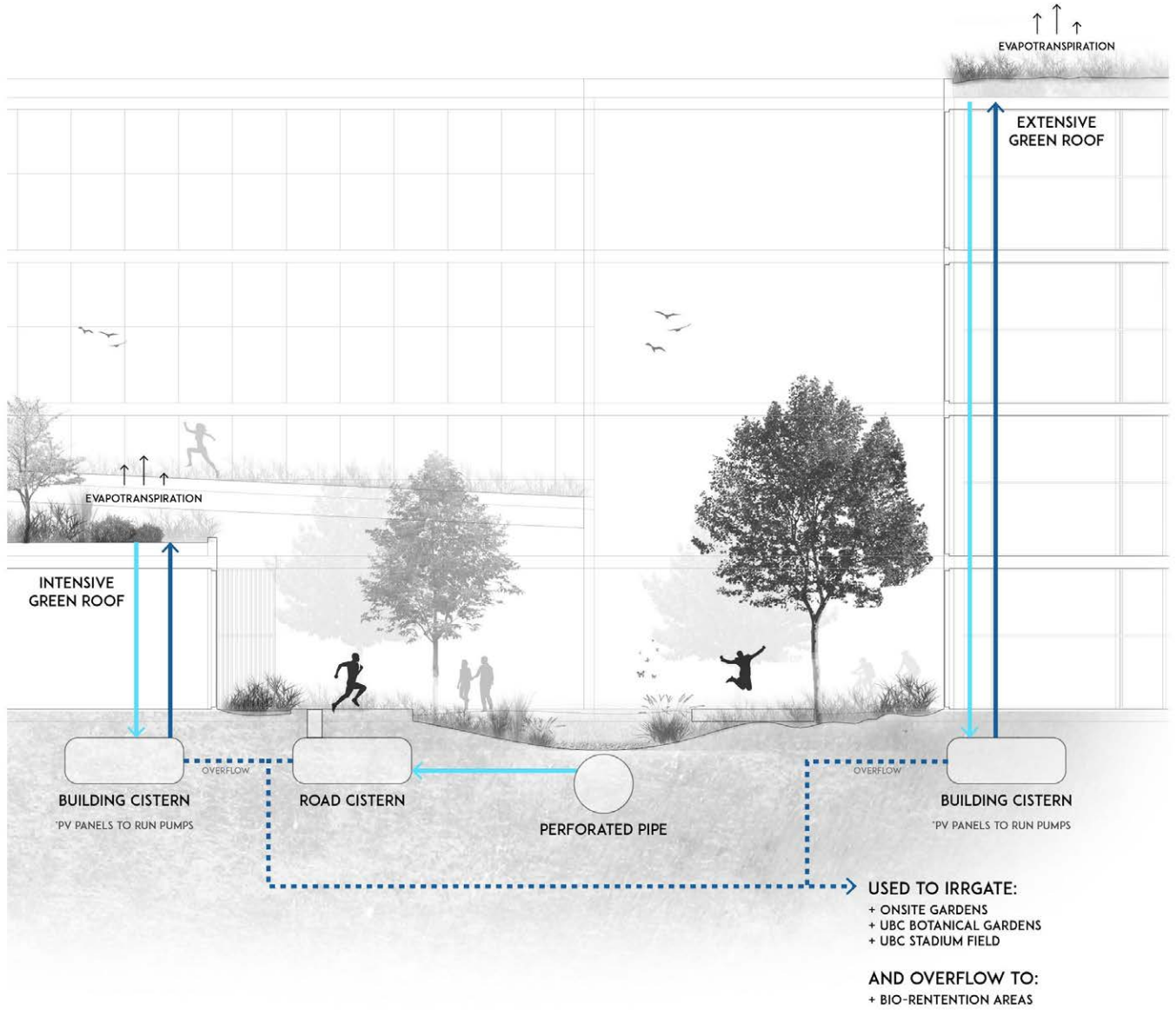



# Business As Usual Scenario

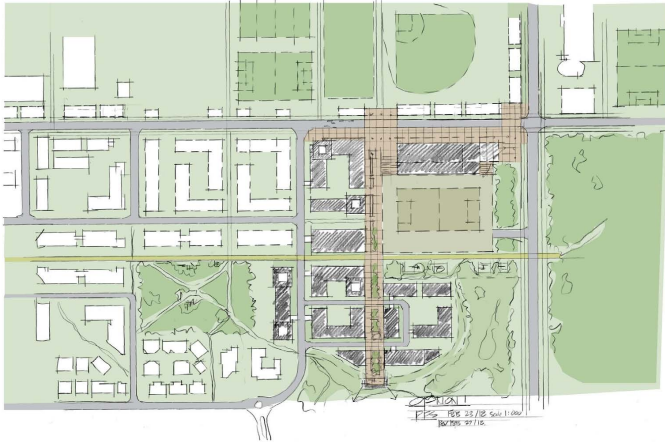

**Area of Roofs:** 23,257 sq m  
**2017 Vancouver Precipitation:** 1,234 mm  
**Potential Rainwater Volume:** 28,700 m<sup>3</sup>

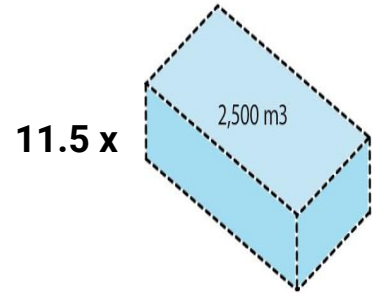

**Olympic Swimming Pool**

**Curve Number Method:** 761.92mm  
**2017 Stormwater Runoff Rate (Q):** 761.92mm  
**Area of Roofs:** 23,257 sq m  
**Stormwater Runoff Volume:** 17,720 m<sup>3</sup>

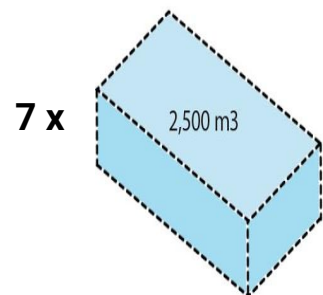

**Olympic Swimming Pool**



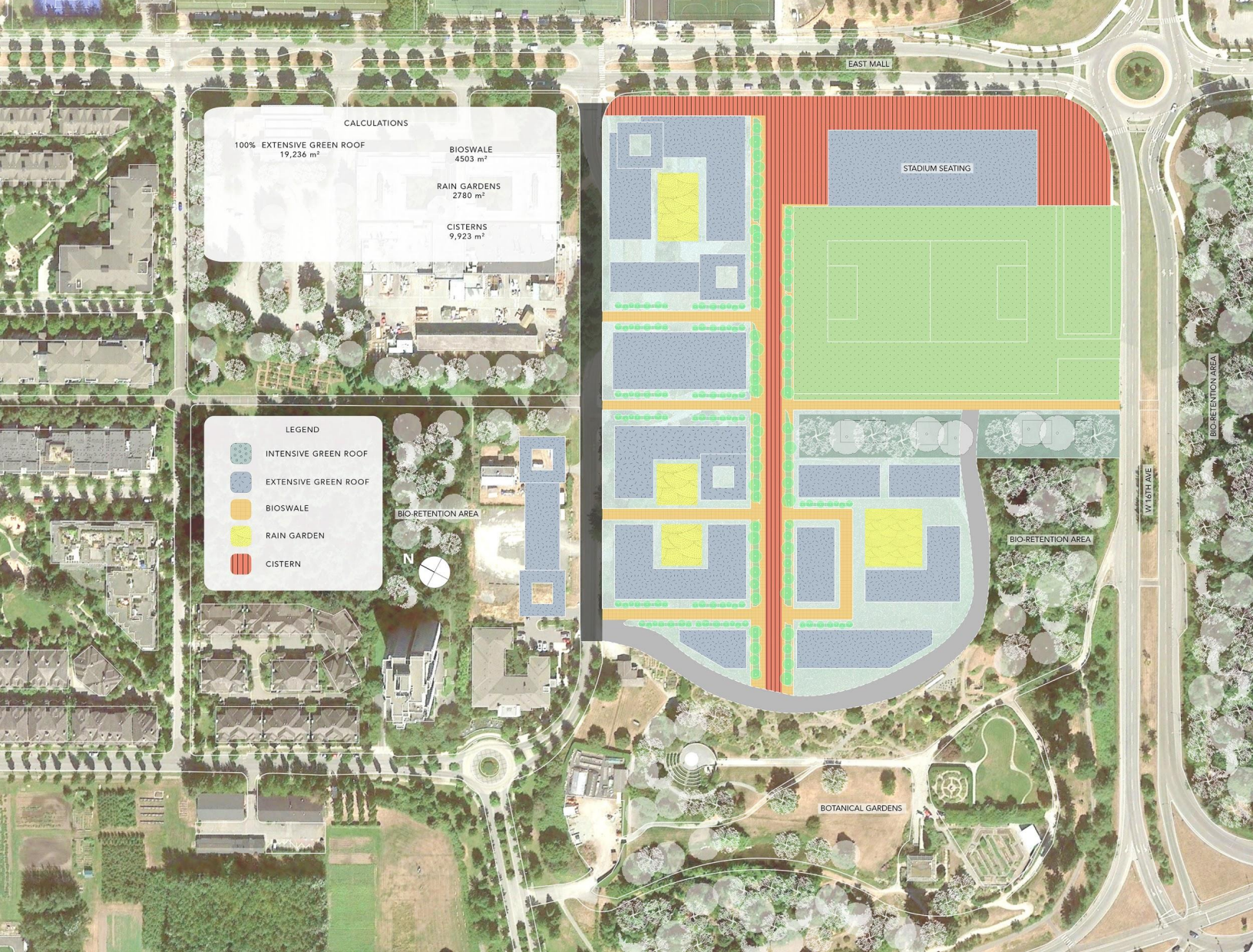

CALCULATIONS

100% EXTENSIVE GREEN ROOF 19,236 m <sup>2</sup>	BIOSWALE 4503 m <sup>2</sup>
	RAIN GARDENS 2780 m <sup>2</sup>
	CISTERNS 9,923 m <sup>2</sup>

LEGEND

	INTENSIVE GREEN ROOF
	EXTENSIVE GREEN ROOF
	BIOSWALE
	RAIN GARDEN
	CISTERN

**Stormwater Mitigated on 100% Extensive Green Roof: 975 m<sup>3</sup> (5.5%) annually**

1,800 m<sup>3</sup> of water to irrigate in summer months if extensive roof plants kept all year round

**Stormwater Mitigated on 50%\* of Site: 62,180 m<sup>3</sup> (90.7% incl green roofs) annually**

Assuming Neighbourhood site = 90,000 sqm, buildings = 23,257 sqm, and field = 19,000 sqm. 50% of 47,740 is 23,870 m<sup>2</sup> + 19,000 m<sup>2</sup> of green ground surfaces.

Note: Area calculations are rough estimates based on preliminary hand sketches



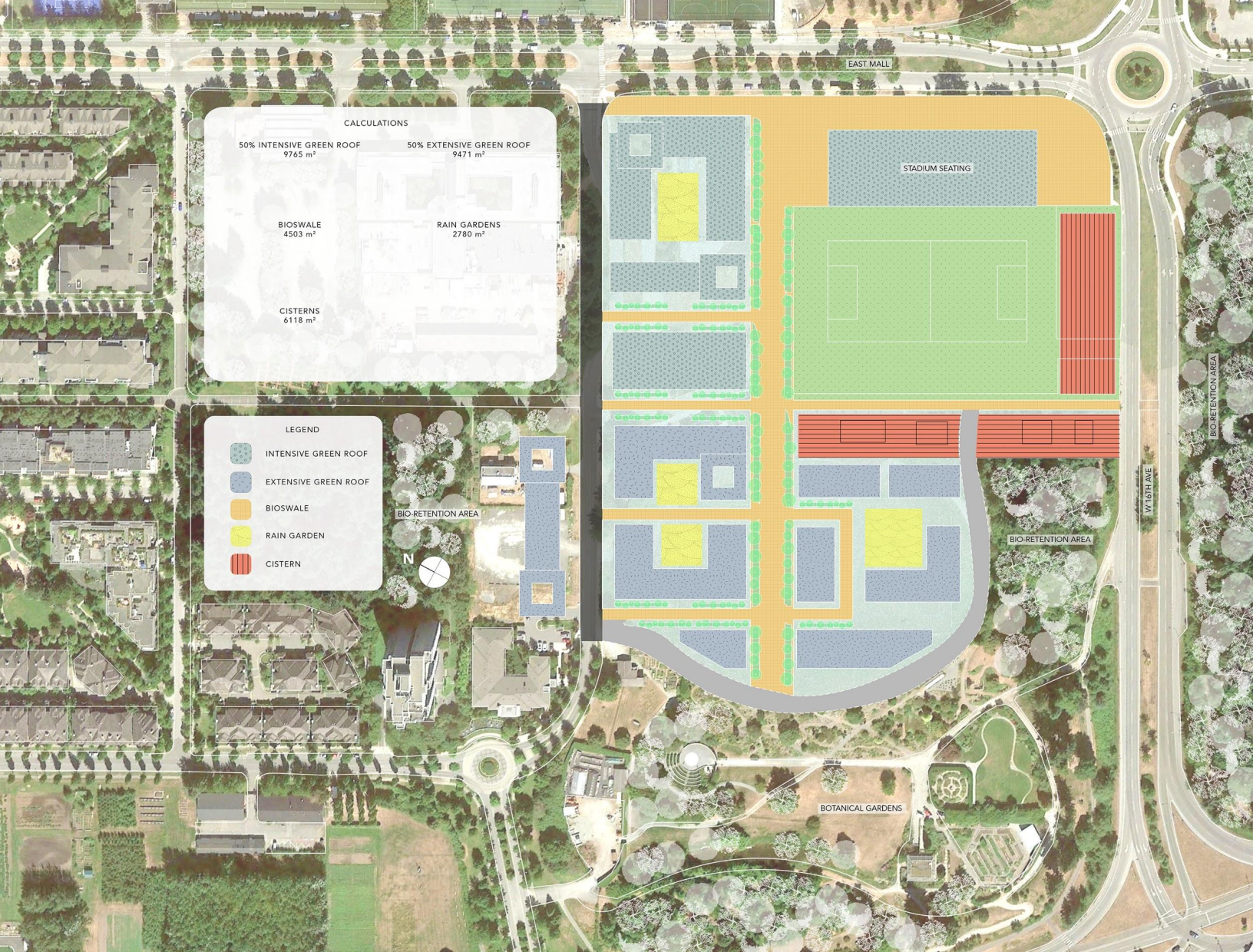

**Stormwater Mitigated on 50% Ext. 50% Int. Green Roof: 1,385 m3 (7.8%) annually**

932 m3 of water to irrigate in summer months if extensive roof plants kept all year round. Intensive roofs would require more.

**Stormwater Mitigated on 75%\* of Site: 65,369m3 (95.3% incl green roofs) annually**

Assuming Neighbourhood site = 90,000 sqm, buildings = 23,257 sqm, and field = 19,000 sqm. 75% of 47,740 is 35,800 m2 + 19,000 m2 of green ground surfaces.

Note: Area calculations are rough estimates based on preliminary hand sketches



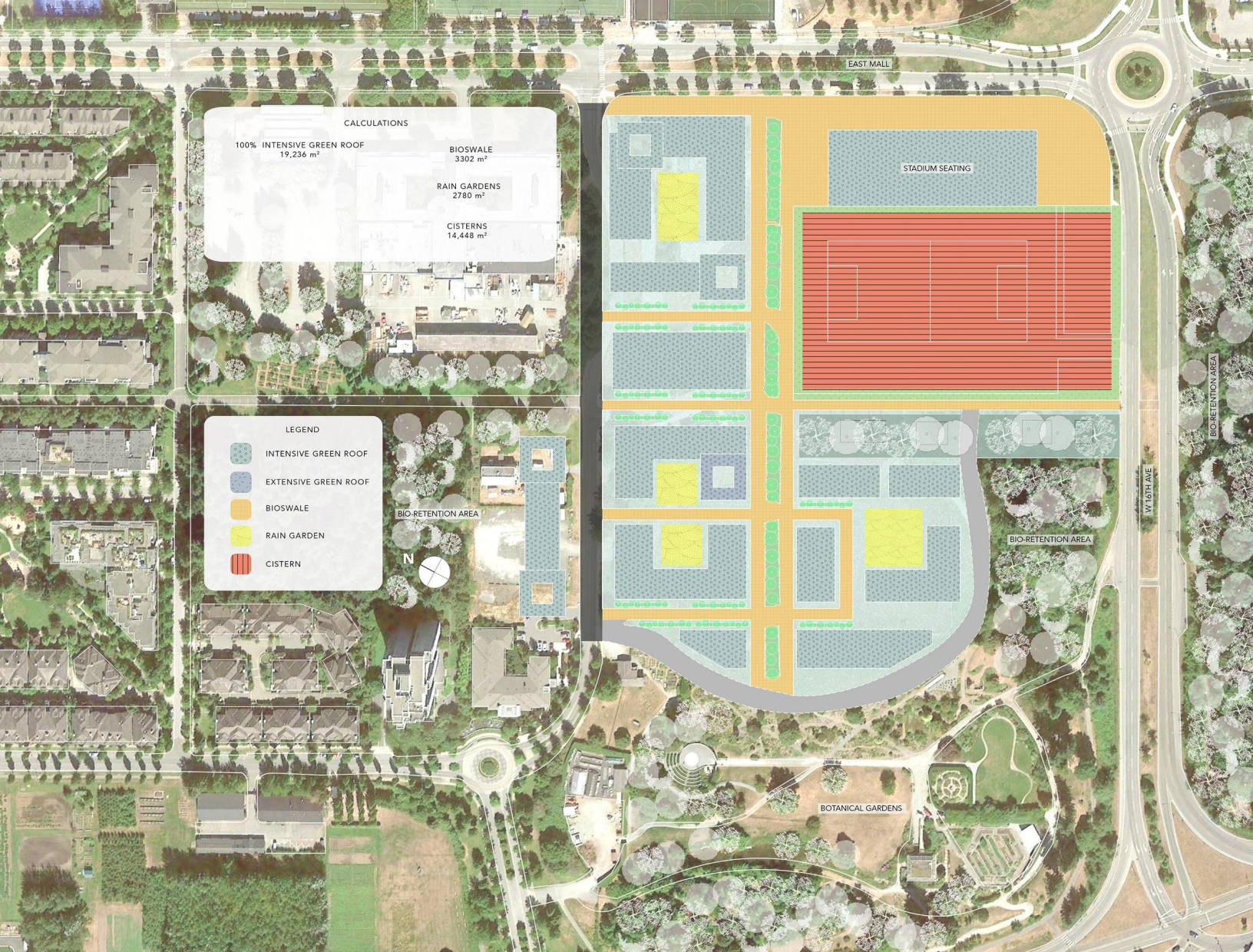

**Stormwater Mitigated on 100% Intensive Green Roof: 1,770 m3 (10%) annually**

Intensive roofs would require irrigation.

**Stormwater Mitigated on 75%\* of Site: 79,930 m3 (95.3% incl green roofs) annually**

Assuming Neighbourhood site = 90,000 sqm, buildings = 23,257 sqm, and field = 19,000 sqm. 75% of 47,740 is 59,250 m2 of green ground surfaces.

Note: Area calculations are rough estimates based on preliminary hand sketches



# Collaborative Network of Stormwater Management

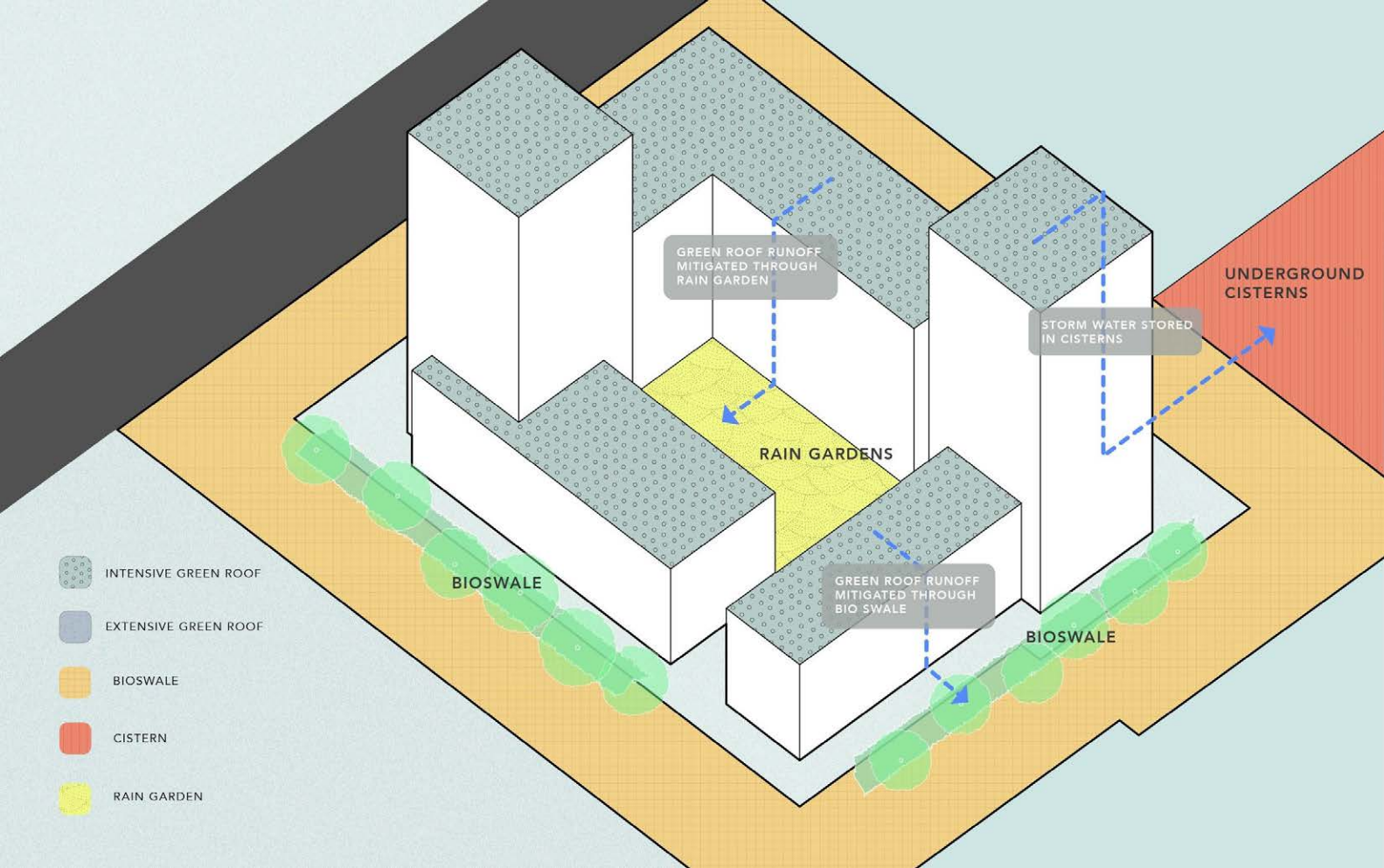

# Armouries Hub

Feng Wu (MLA), Xue Li (MUD), Shiyu Wu (MUD), Wenwen Zhuang (MU)

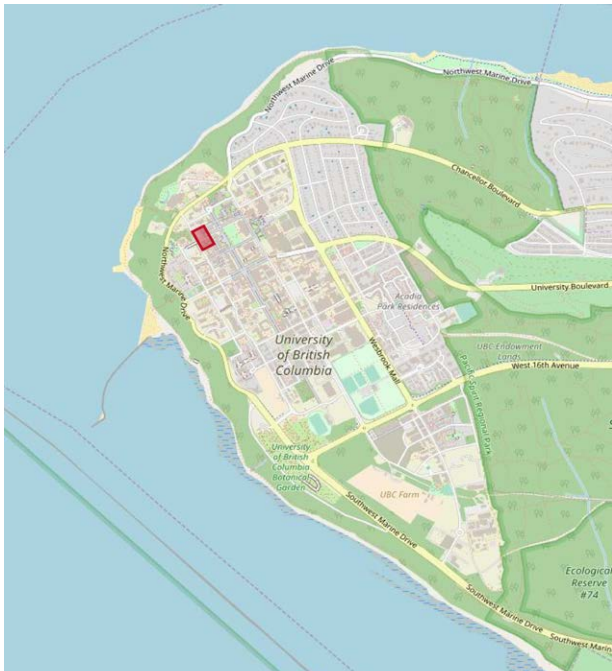

Location Map

Armouries Hub is located in the Northwest area in UBC as shown in the location map above.

In the context map, we can see that the site is cut through by Memorial Road, adjacent to Frederic Wood Theatre, School of Music and Information Technology Building. There are two existing buildings in site with a large area of parking lot. Most of the existing area is impermeable.

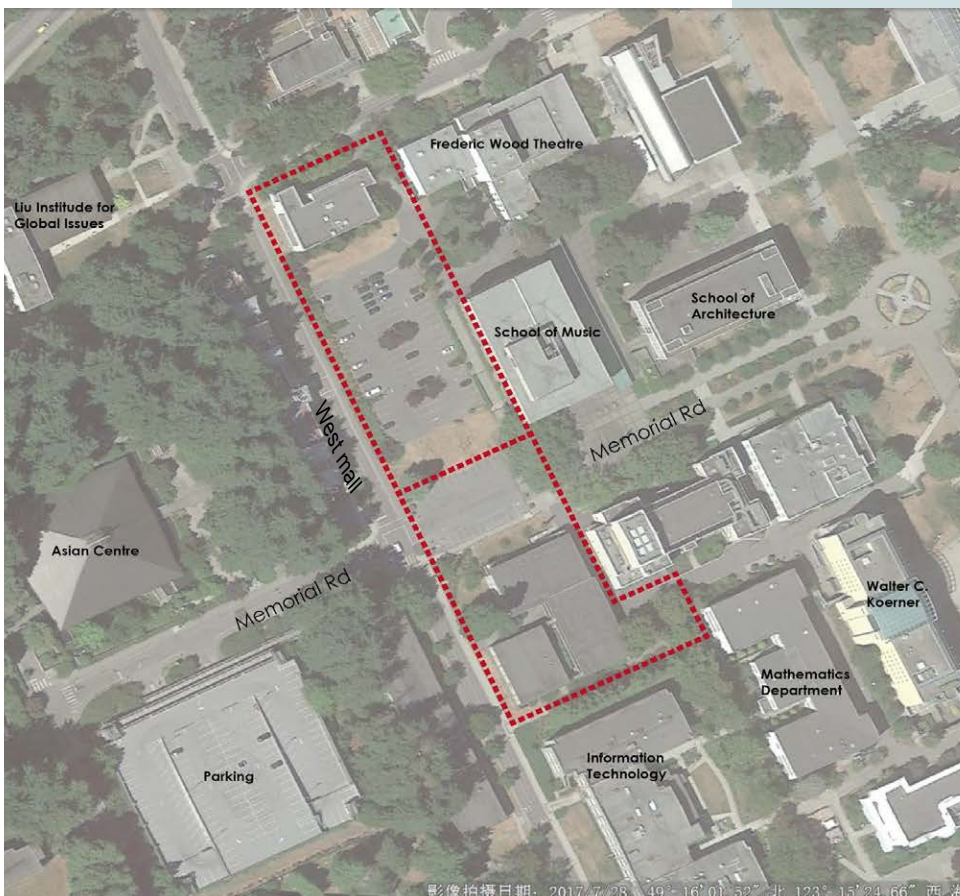

Context Map

影像拍攝日期: 2017/7/25 49° 16' 01.52" 北 123° 15' 24.66" 西 海



# Amouries Hub

## Proposed Building Plan

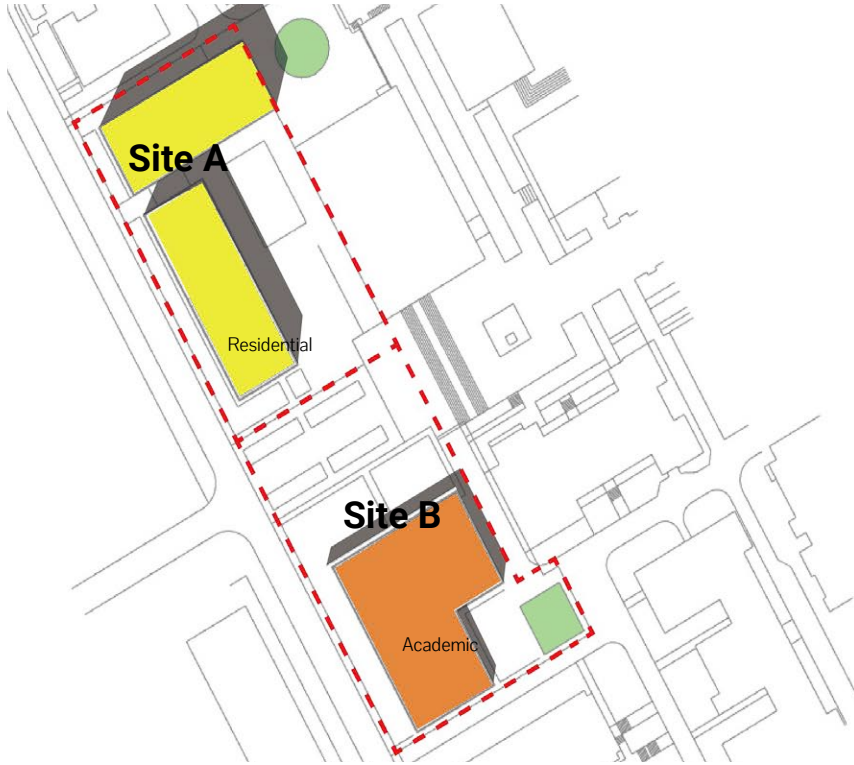

In the Proposed building map, two new residential building will be built in the north part of the site while an academic building will be proposed in the south part.

## LID Strategies Plan



A series of LID (Low Impact Development) strategies including extensive roof, runoff-collecting tank, rain garden and bioswales are suggested for the new buildings and the adjacent space for reducing the runoff from site and a better using experience based on our calculation. With the application of these strategies, runoff in the north part will be reduced by 97.33% and the reduced runoff will be 81.66% in a year.



# Amouries Hub

## Site A Calculation



Gross Site Area: 3800 m<sup>2</sup>  
 Roof Area: 2075 m<sup>2</sup>  
 Green Area: 260 m<sup>2</sup>  
 Grey Area: 1465 m<sup>2</sup>

Gross Site Area: 3800 m<sup>2</sup>  
 Green Roof Area: 1200 m<sup>2</sup>  
 Walkable Roof Area: 875 m<sup>2</sup>  
 Green Area: 1230 m<sup>2</sup>  
 Grey Area: 495 m<sup>2</sup>

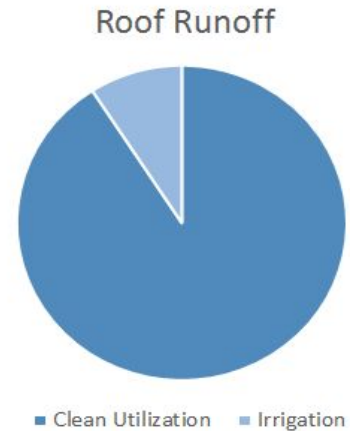

Roof Runoff: 1494.11 m<sup>3</sup>/year  
 (reduced 5.49% by green roof)  
 Irrigation for July, August and September = 165.39 m<sup>3</sup>/year  
 Ground Run of 35m<sup>3</sup>/year  
 (reduced 97.34% by rain garden)

### Analysis of Area of Green Space

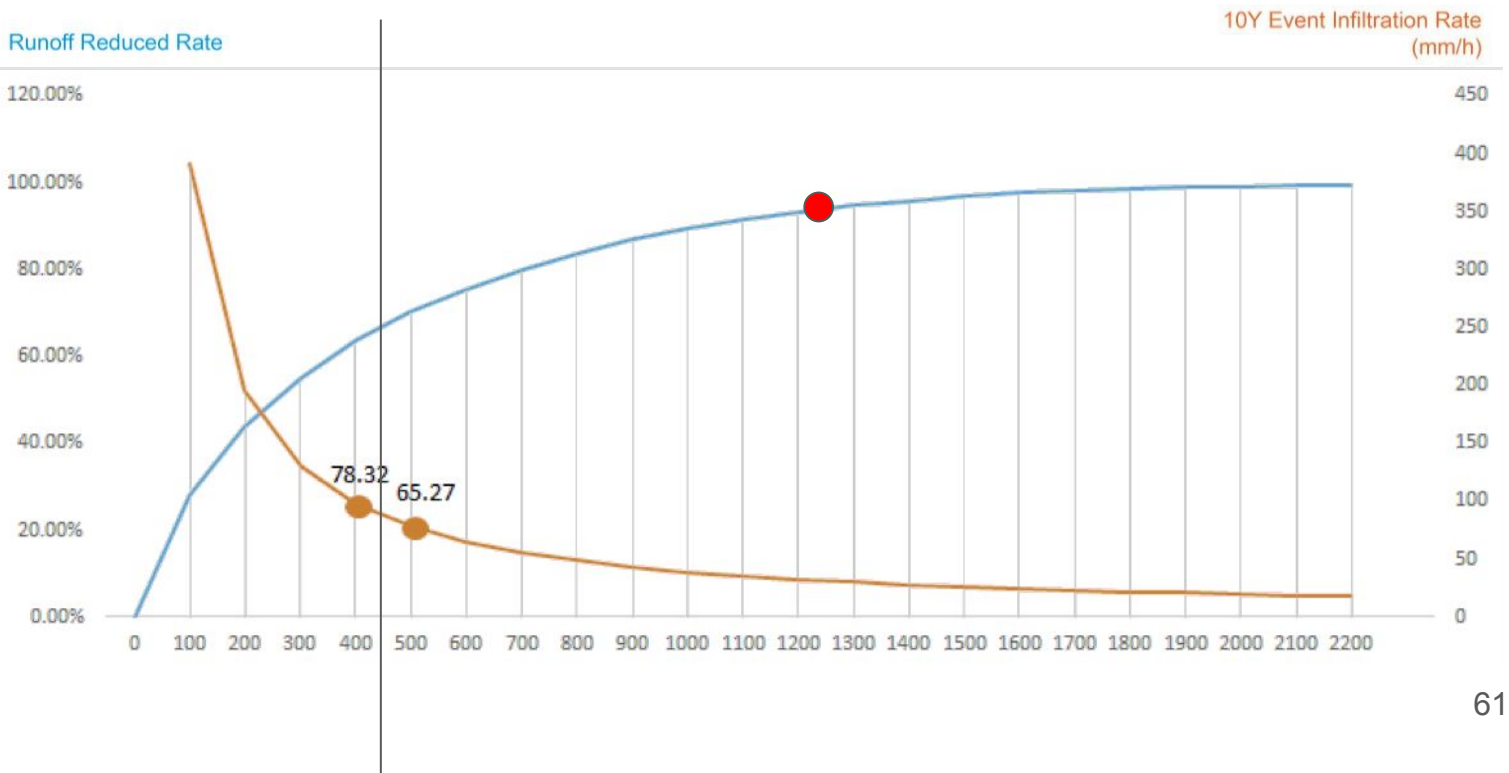

# Amouries Hub

## Site B Calculation



Roof Runoff: 965.80 m<sup>3</sup>/year (reduced 4.26% by green roof)  
 Ground Run of 497.50m<sup>3</sup>/year (reduced 81.66% by rain garden)

Gross Site Area: 3561 m<sup>2</sup>  
 Roof Area: 1324 m<sup>2</sup>  
 Green Area: 770 m<sup>2</sup>  
 Grey Ara: 1467 m<sup>2</sup>

Gross Site Area: 3561 m<sup>2</sup>  
 Green Roof Area: 993 m<sup>2</sup>  
 Walkable Roof Area: 331 m<sup>2</sup>  
 Green Area: 1182 m<sup>2</sup>  
 Grey Ara: 1055 m<sup>2</sup>

Analysis of Area of Green Space

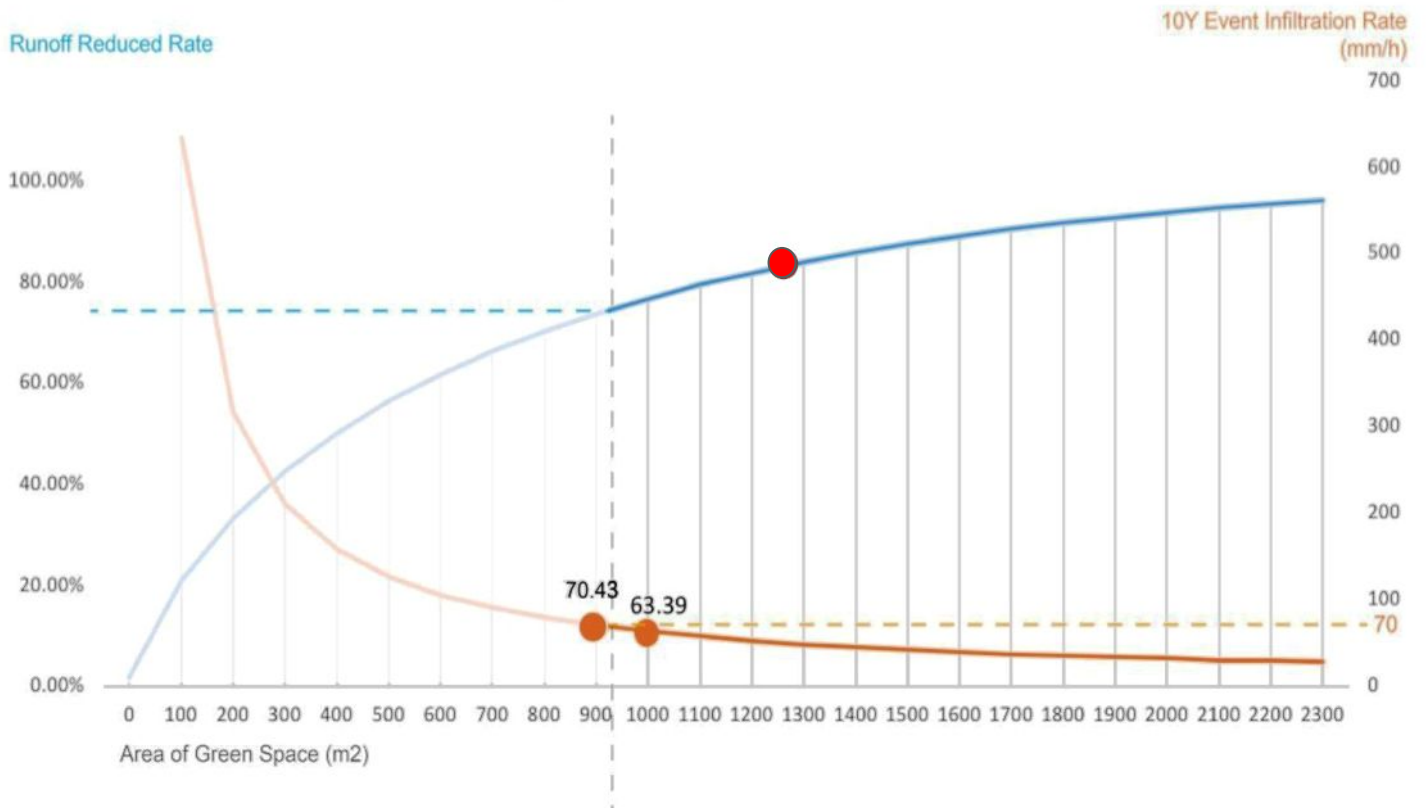

# Amouries Hub

## Site Plan

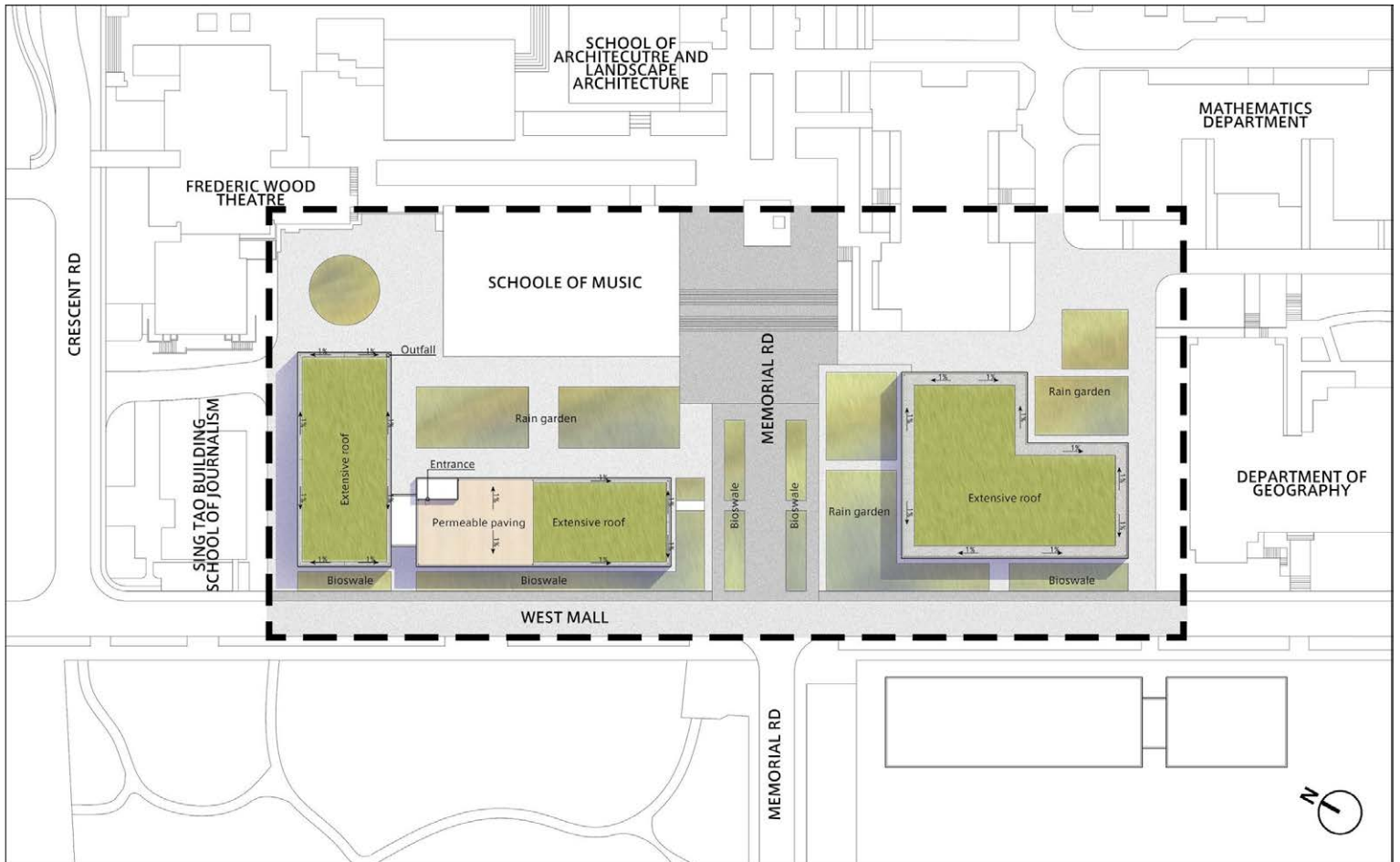

The proposed design is separated to two parts, which are a residential building in the north and an academic building in the south. On the top of the residential building, the design proposes an activity space with permeable pavings to achieve goals of public realms and stormwater management. The academic building is with an extensive living roof. Both living roofs can storage the rainfall and reuse it for irrigation and domestic usages. The rain gardens and bioswales on the ground, absorbing the runoff from the roofs and ground, provide beautiful landscapings for the surrounding faculties.

By between is proposed bioswales on the Memorial Road, which shifts the original parking area to a space with the LID strategy. The bioswale can continue a sense of ceremony on the Memorial Road with sustainable concerns.



# Amouries Hub System

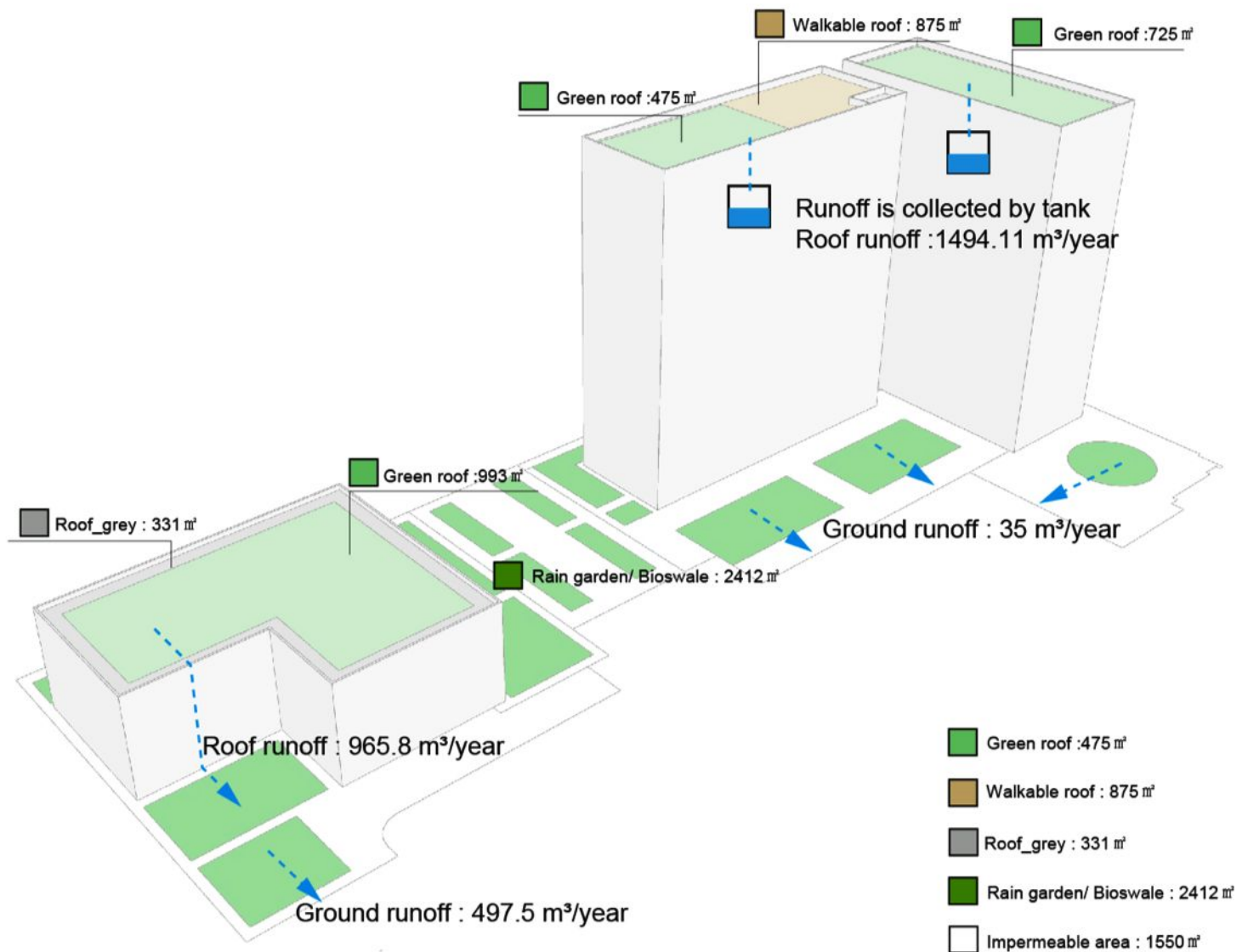

The total area of site A is 3800 square metre, including 2075 square metre of the roof, 260 square metre of the green area, and 1465 square metre of the paving area. Every year the roof can collect 1411.5 square metre of rainwater runoff, and the bioswales and rain garden on the ground can collect 33.18 square metre of runoff. Rainwater runoff will be collected by a tank and be used for the toilet usage and irrigation for plants.

The total area of site B is the same as site A includes 1200 square metre of the roof, 875 square metre of the walkable roof top garden, 1230 square metre of the green area, and 495 square metre of the paving area.

# Amouries Hub

## Sections

### Edge Detail

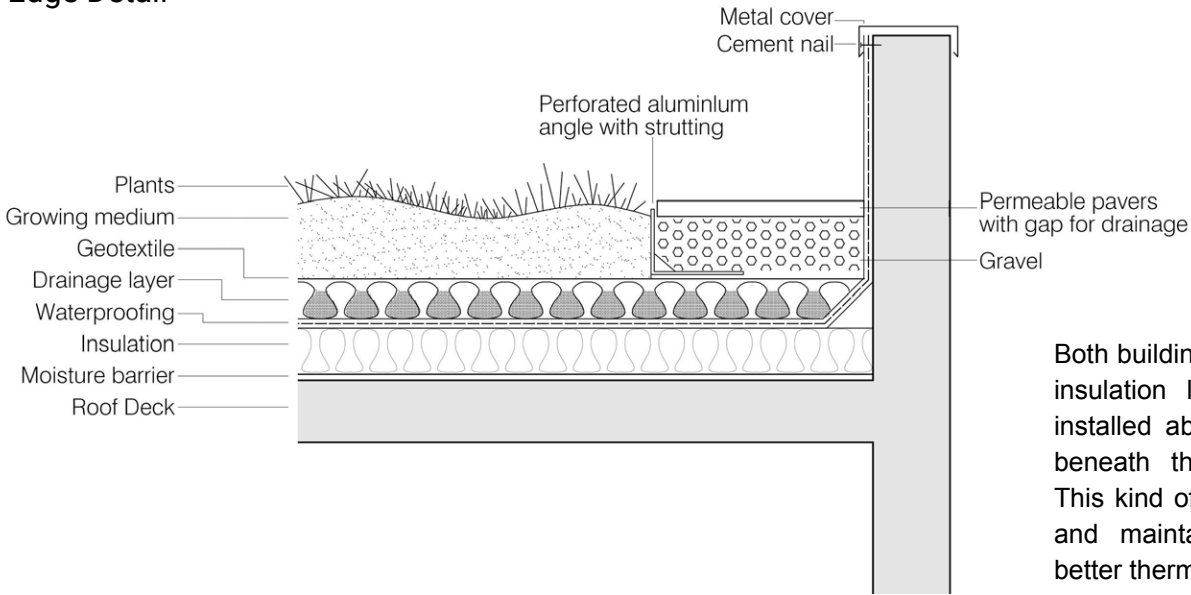

Both buildings use warm roofs. The insulation layer in warm roof is installed above the roof deck and beneath the waterproofing layer. This kind of roof is easier to install and maintain as well as offers better thermal performance.

### Outfall Detail

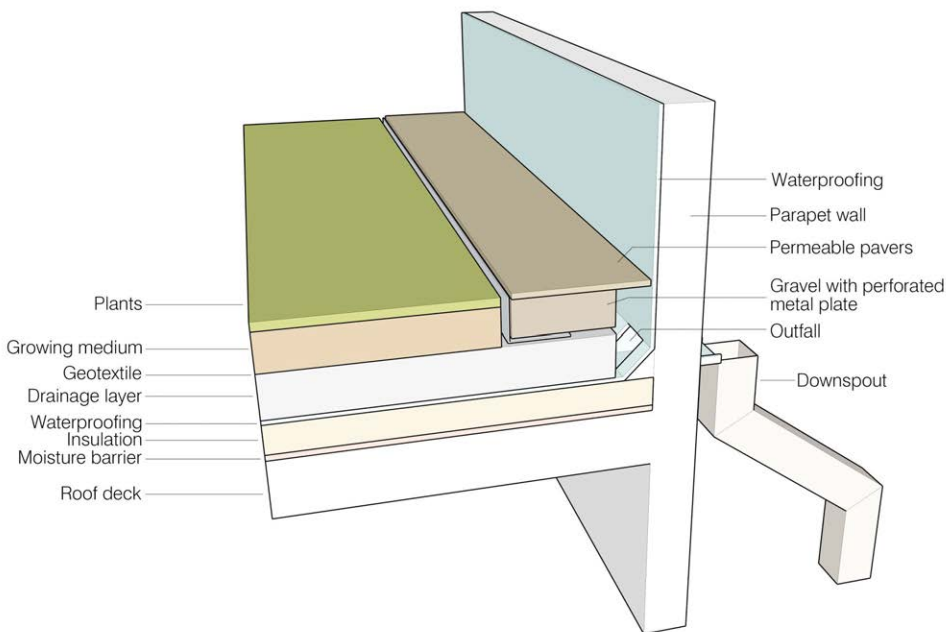







The section shows the detail of the junction between green roof and surrounding maintenance passageway. The passageway uses permeable pavers with gap for drainage. Gravel was placed under the pavers to keep the tile and the green space at the same height. The roof, parapet and outfall are covered with waterproofing layer.

# Amouries Hub

## Plants



### Green roof

Common name	Latin name	Type
-------------	------------	------

<b>Goldmoss stonecrop</b>		<i>Sedum acre</i>	Sedum
<b>Cliff Stonecrop</b>		<i>Sedum cauticola</i>	Sedum
<b>Jenny's stonecrop</b>		<i>Sedum reflexum</i>	Sedum
<b>Yarrow</b>		<i>Achillea millefolium</i>	Perennials-Sun
<b>Sea pink</b>		<i>Armeria maritima</i>	Perennials-Sun
<b>Pacific anemone</b>		<i>Anemone multifida</i>	Perennials-Sun
<b>Bluebell bellflower</b>		<i>Campanula rotundifolia</i>	Perennials-Sun

### Bioswales/ rain garden

Common name	Latin name	Type
-------------	------------	------

<b>Red osier dogwood</b>		<i>Cornus sericea 'kelseyi'</i>	Shurbs/ Sun
<b>Siberian iris</b>		<i>Iris sibirica</i>	Perennials-Sun
<b>Lakeshore sedge</b>		<i>Carex Kelloggii</i>	Perennials-Sun
<b>Rose spirea</b>		<i>Spiraea douglasii</i>	Shurbs/ partial shade
<b>Salal</b>		<i>Gaultheria shallon</i>	Shurbs-Sun/ partial shade
<b>Slough Sedge</b>		<i>Carex obnupta</i>	Perennials-Sun/ partial shade
<b>Lady fern</b>		<i>Athyrium filix-femina</i>	Fern-Shade/ partial shade

### Plans in bioswales/ rain garden

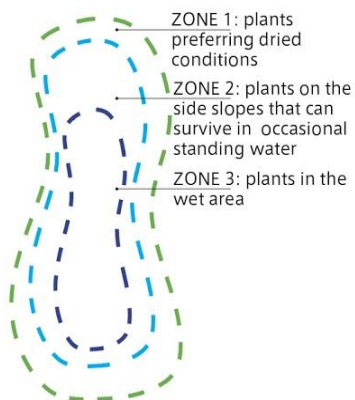

### Plans in green roof

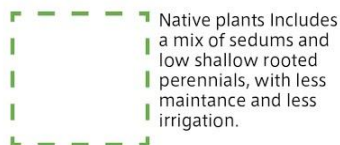



# LIVING ROOF CASE STUDY: KENSINGTON PLACE

LARC 582E SUMMARY REPORT

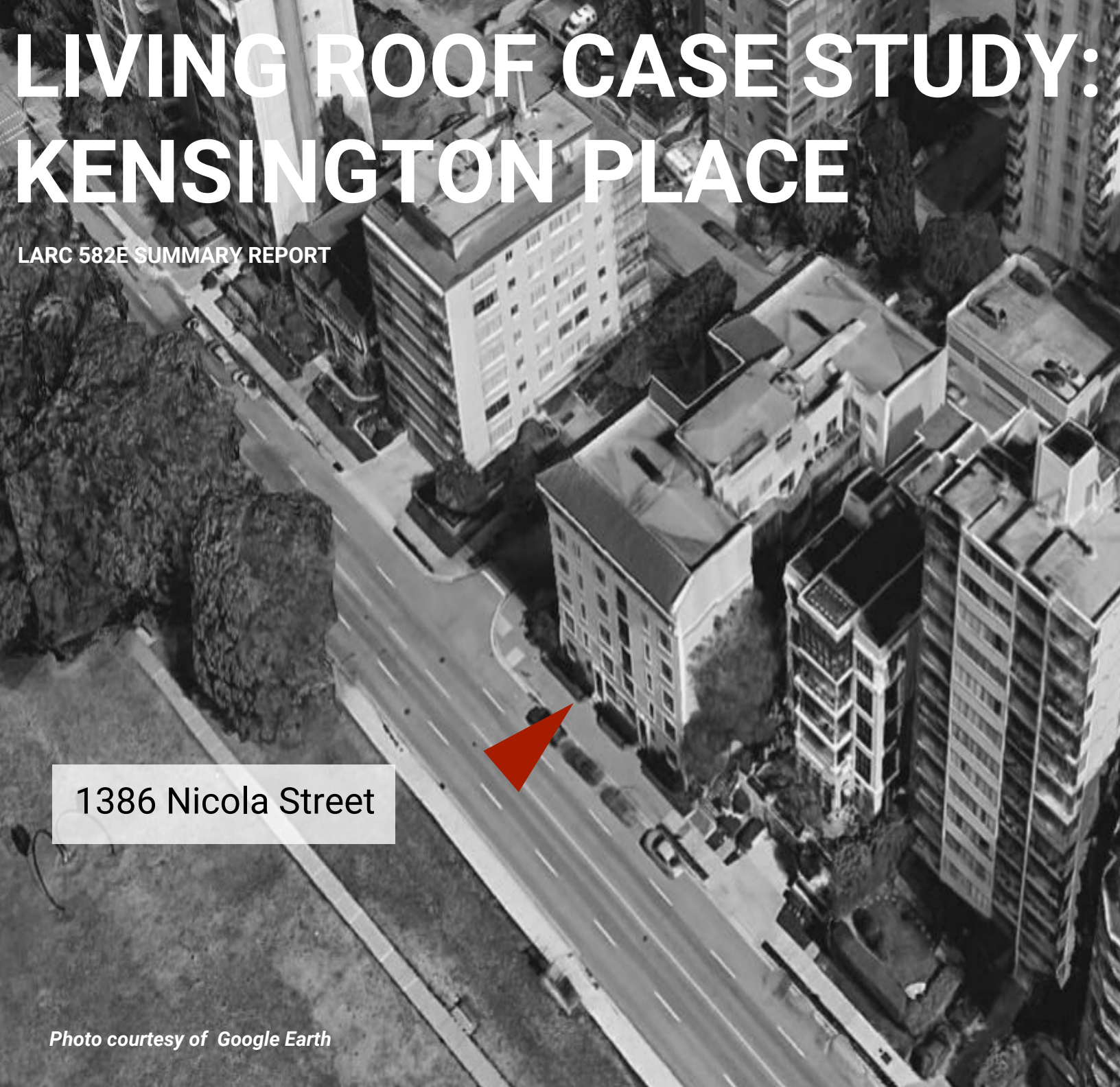
An aerial photograph of a city street, likely in Vancouver, showing several multi-story buildings. A red arrow points to a specific building on the right side of the street. The street is lined with trees and has a sidewalk. The overall scene is in black and white, except for the red arrow.

1386 Nicola Street

*Photo courtesy of Google Earth*

Kensington place, a building retrofit project, allowed the class to explore the breadth of living roof projects within the context of Vancouver.

**KARIANNE HOWARTH & REBECCA ANDERSON**

# INTRODUCTION

## Context Summary



- Located at the corner of Nicola St. and Beach Avenue
- A Residential Heritage Property
- Built in 1912 by Architect Phillip Julien (“List of Heritage Buildings in Vancouver”)
- Ecological network potential (adjacent to Seawall, less than 1.5 km to Stanley Park)
- 88% of Vancouver’s downtown is grey (stress on stormwater system)(*Living Roofs in Integrated Urban Water Systems*)

- Located in a vibrant neighbourhood close to Sunset Beach and Davie Street.
- Ocean View
- The integration of social space is an important part of program

# EXISTING CONDITIONS

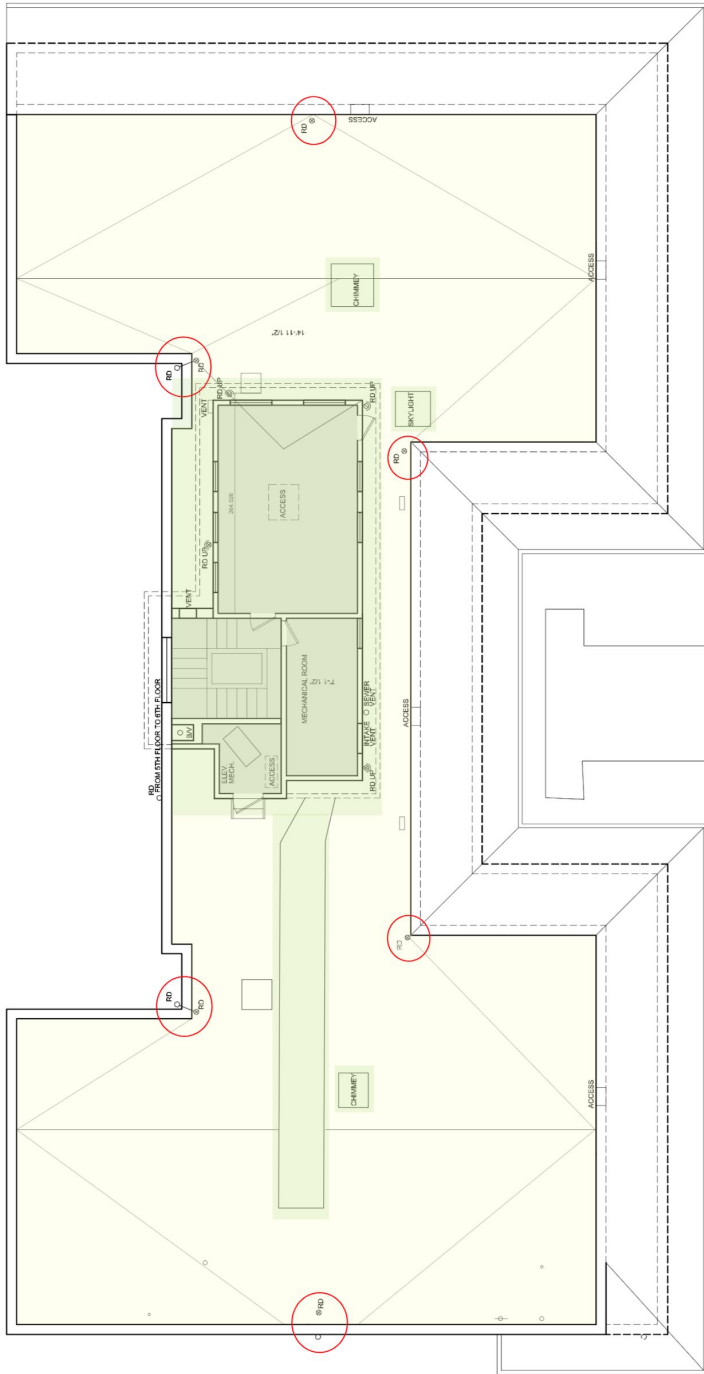

1:100

Kensington Place Roof Plan

Building Plan from Structural Engineer

The roof of this 106 year old building is has approximately 465 m<sup>2</sup> of surface area which needs to be drained (yellow area).

It is currently well equipped with 6 drainage points (red circles), 3 that flow through the building structure (top and left), and three that connect horizontally through the parapet (bottom and right) to downspouts located on the exterior of the building. All are currently connected to the city sewer system. There have been past issues with roof membrane leakage around drain penetrations, it is currently difficult to access the interior of the drain for cleaning, and the age of the pipes are such that corrosion and detreous may have built up blockages especially in the horizontal connectors.

The roof is host to a number of unique features including a sky light, a large metal fire ventilation shaft, 2 working chimneys and a small indoor office space with attached mechanical rooms and stair access to the floor below (green highlight).

Perhaps the greatest defining feature of this roof is the variability and severity of the roof's slope which is nearly 20% in some areas (crease lines show convex and concave angles)

The site has strong solar access, which will create bright, hot and dry conditions at the height of summer, with little shade or protection from wind.

The current roof membrane is approx. 25 years old and is due for replacement.



# LIMITATIONS

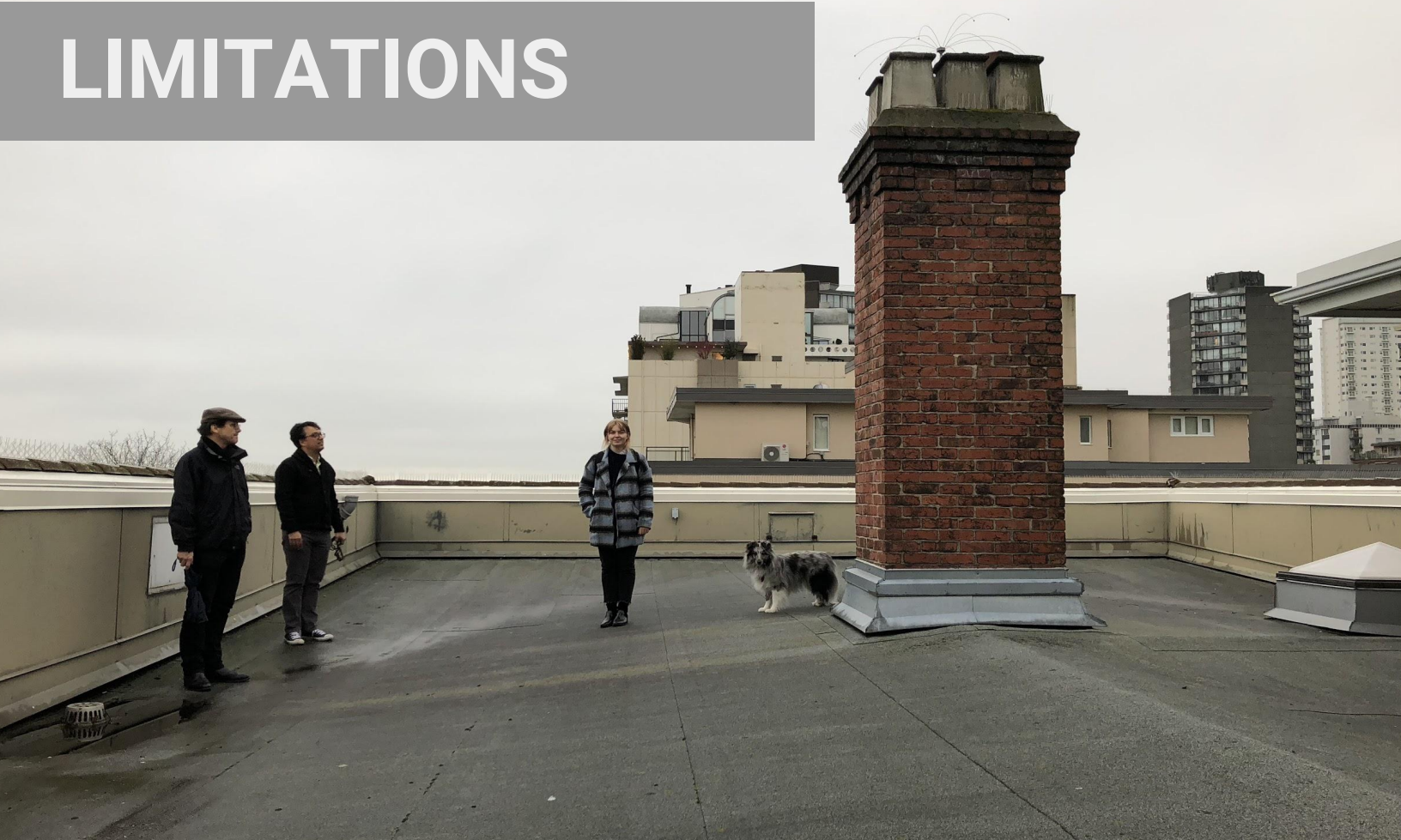

The location and character of Kensington Place presents a number of opportunities as well as significant challenges. As previously mentioned, this property is a protected heritage building, and thus the character and structure of this property cannot be significantly altered. Any proposed interventions would have to be approved by the City of Vancouver as well as the site's structural engineer.

The building's roof has slopes of up to 20% in certain areas, which presents a challenge to the construction of any proposed social infrastructure (such as decking or seating areas), and the max weight allowance due to its age and build, limits opportunities for heavy materials or deep soils.

Plant selection will be limited due to Vancouver's extremely variable climate (summer drought and excess winter moisture), along with the strong solar aspect, high heat and wind conditions of this exposed site.

\*Two safety issues must be taken into consideration: the building's low parapet at the apex of the roof slope could be a falling hazard if roof deck is elevated, and proximity to the ocean may produce high winds and air turbulence which could easily dislodge and eject fixtures, potentially injuring people or damaging property in the vicinity.

# STORMWATER RUNOFF: BUSINESS AS USUAL

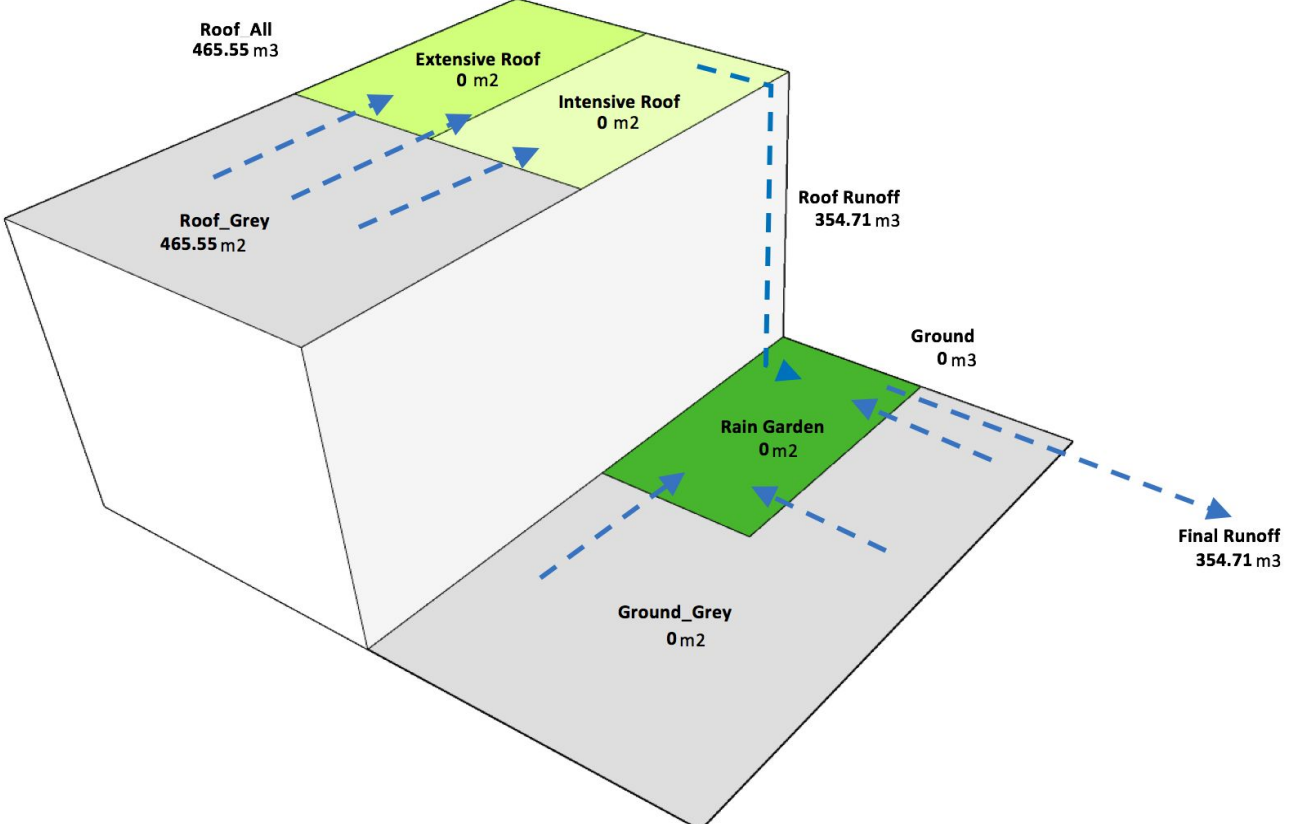

The current runoff from the building's roof top area has been calculated to be 335.73 m<sup>3</sup>, which is about the volume equivalent to 5 large size shipping containers.

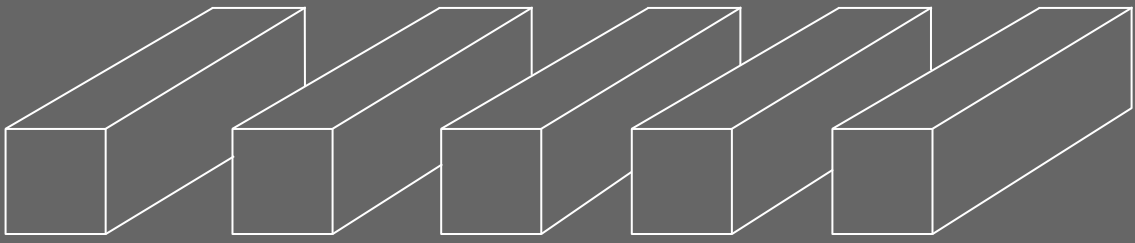

Current Status= 335.73 m<sup>3</sup> runoff per year

# STORMWATER RUNOFF REDUCTION POTENTIAL

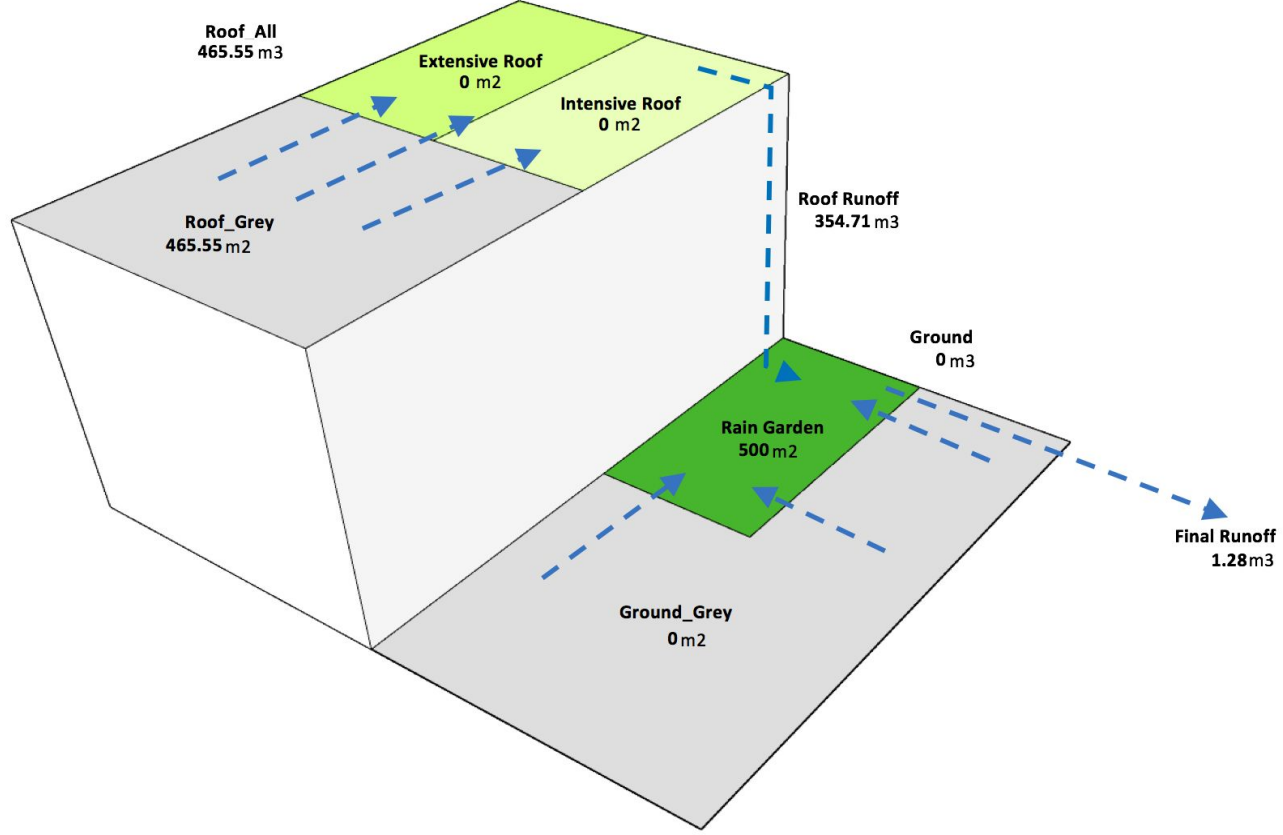

The study revealed that an extensive living roof (a single shallow layered system that spans the majority of the roof's area) at Kensington Place would result in a 5.49% reduction in annual stormwater runoff (Roehr and Fassman-Beck). Given the relatively low percentage of reduction, it was determined that additional stormwater control measures (such as a bioswale or rain garden) would be necessary in order to achieve a stormwater retention rate of 100%. Further calculations determined that a rain garden of 500 m squared would need to be constructed. However, a rain garden is not advisable at the moment, due to the disruption it would cause to the existing mature landscape and lack of available groundspace. Due to weight restrictions and the challenges associated with installing planting infrastructure on this roof, an intensive living roof (a multilayered system that requires a soil depth greater than 6") is not advisable (Roehr and Fassman-Beck). Despite nearly negligible reductions of stormwater runoff, the application of an extensive living roof would be an effective measure in reducing peak flow during an extreme rain event, improve the social and ecological functions of this space, increase the longevity of the roof membrane, reduce thermal loss (potentially resulting in reduced energy costs) and increase insulation (*Living roofs in Integrated Urban Water Systems*).

**Full Green Roof= 5.49% Reduction**  
**Full Green Roof + 500 sq m rain garden = 99.5% Reduction**



# DESIGN CONSIDERATIONS

- **MODULAR:** A modular design will allow for the greatest adaptability, installation and ease of maintenance. Both of our design recommendations include lightweight custom planting beds and decking, which can be assembled and easily craned up to the roof, avoiding potential interior access issues and damages.
- **INSTALLATION/SAFETY:** All infrastructure (such as planting beds and decking) must be fixed to the roof to avoid wind uplift and blow off. Fixing points must be correctly installed, ensuring that the integrity of the roof's waterproofing membrane is not compromised. Detailed example is included for reference
- **DRAINAGE:** The existing surface level drainage points are adequate and need not be relocated, but new drains and leaf guards should definitely be installed when the roof is replaced. Correct installation of drain housing is detailed to prevent leakage, and a unit with easy access for cleaning is included for reference. \*\*We recommend that the drainpipe itself, and especially the horizontal connectors be inspected when the roof membrane is replaced to ensure that the drains free of buildup and are draining properly.
- **AESTHETIC:** Simple clean modern lines have been chosen to keep the decking and planting supports minimal, easy to clean, and to allow for the plants to be the main attraction. They should appear to float above the slopes of the roof allowing the character of the original roofline to be appreciated.

# PLANTS

Selecting a variety of hardy wind, drought and moisture tolerant plant species will be essential to the success of this project. Other considerations, such as the aesthetic and ecological value of the species selected, are also important. The weight and flammability of the growing medium and selected plants should also be considered (Vogt). Plant species that can spread seeds freely and germinate on the roof should also be avoided (“Native Plants for Green Roofs”). As the primary objective of this seminar is to produce recommendations for low impact development, it is preferable to select species that require no additional irrigation (although irrigation is feasible in this location). Sedums typically have the highest survival rate given the extremely variable climate in Vancouver, and require little maintenance and no additional water (Roehr and Fassman-beck). On the next two pages we have proposed a variety of lightweight, and aesthetically appealing planting palettes that would thrive at Kensington Place. All of the recommended plant species can be locally sourced at nurseries such as [Nat’s Nursery](#). We recommend planting modular systems that are grown to 95% at the nursery prior to installation. This is the most cost effective and low maintenance option.

*The Vancouver Convention Centre. Photo courtesy of The Daily Hive*



# SUGGESTED PLANT PALETTES

Designing for the character of the building and its tenants, we suggest the palette to the right (calming), which consists of an elegant selection of blue toned sedums, with pale pink tones in both the leaves and flowers, and a touch of yellow to add and element of surprise and interest.

## CALMING ---->

With the great distance between areas at this site, there is an opportunity to choose different palettes to create a variety of moods.

## UPLIFTING---->



**Sedum cauticola** ,  
Cauticola Stonecrop



**Sedum reflexum**,  
Reflexum Stonecrop



**Sedum spurium**  
'Tricolor', Tricolor  
Stonecrop



**Sedum 'Vera Jameson'**  
, Vera Jameson **Sedum**

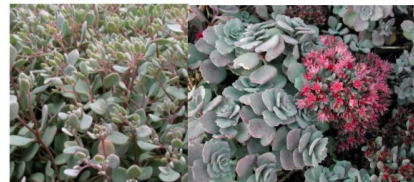

**Sedum cauticola**  
'Lidakense', Lidakense  
Stonecrop



**Sedum pachyclados**,  
Pachyclados Stonecrop



**Sedum album 'Murale'**,  
Murale Stonecrop



**Sedum reflexum Blue**  
Spruce, Blue Spruce  
Stonecrop



**Sedum rupestre**  
Angelina , Angelina  
Stonecrop



**Sedum kamschaticum**  
'Variegatum',  
Variegated Stonecrop



**Sedum kamschaticum**,  
Green Stonecrop



**Sedum sichotense**,  
Sichotense Stonecrop



**Sedum stenopetalum**,  
Worm-leaved  
Stonecrop



**Sedum floriferum**  
'Weihenstephaner  
Gold',  
Weihenstephaner Gold  
Stonecrop



**Sedum oreganum** ,  
Oregon Stonecrop

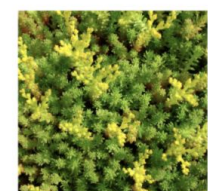

**Sedum sexangulare**,  
Tasteless Stonecrop



# SUGGESTED PLANT PALETTES

Other options to choose from as an overall theme, or perhaps for a quadrant of the roof to enjoy a variety of texture and colour

**GENTLE----**>



**Sedum album,**  
Stonecrop



**Sedum spurium 'Album Superbum',**



**Sedum reflexum Green Spruce, Green Spruce Stonecrop**



**Sedum album 'Chloroticum', Chloroticum Stonecrop**



**Sedum reflexum Blue Spruce, Blue Spruce Stonecrop**



**Sedum spurium 'Dragons Blood', Two-Row Stonecrop**



**Sedum spathulifolium, Broad-leaved Stonecrop**



**Sedum spurium 'Fuldaglut', Fuldaglut Stonecrop**



**Sedum purpureum 'Autumn Joy', Purple Stonecrop**



**Sedum album,**  
Stonecrop



**Sedum album 'Murale', Murale Stonecrop**

**WARMING----**>

# LIVEROOF

Nat's Nursery works exclusively with the LiveRoof module system for their green roof installations. The plants are grown in the modules at the nursery, and a specialized "soil elevator" allows for a lush, seamless green roof the day of installation (*LiveRoof® « NATS Nursery Ltd.*).

The LiveRoof system is designed to ensure the success of your green roof project and do so at the lowest possible total system cost. This takes into account more than just the acquisition cost, but also addresses maturation costs, maintenance costs, and life cycle costs of owning a living roof system. By working to reduce these costs LiveRoof has created the best value available.

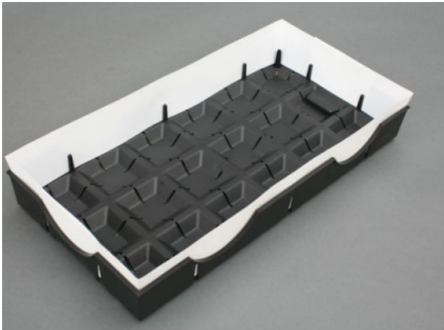

STEP 1

*The Licensed Grower inserts the LiveRoof® Soil Elevator™ into the module.*



STEP 2

*LiveRoof® module is filled to the top of Soil Elevator™ with LiveRoof engineered growing medium.*



STEP 3

*LiveRoof® plants are grown to maturity approximately 1 inch above the LiveRoof module.*



STEP 4

*Certified Installer sets LiveRoof® modules tightly in place on the roof within RoofEdge® aluminum edge restraint.*



STEP 5

*LiveRoof® Soil Elevator™ is removed for a beautiful, seamless instantly mature green roof.*



STEP 6

*Water thoroughly to settle any loose growing medium and to get your green roof off to a great start.*

# LIVEROOF

There are 2 soil depth options that are suitable for Kensington place, the "lite" version with a soil depth of 2", and the "standard" system at 4" of soil. Consultation with an engineer will determine which version is recommended based on roof weight limitations of Kensington Place.

The standard system would be a good design choice as it would support larger plants with a greater ability to withstand drought, especially due to the open bottom nature of the frame system, where air will circulate and dry the soil more rapidly.

## LiveRoof STANDARD SYSTEM

Over Conventional Roofing Assembly

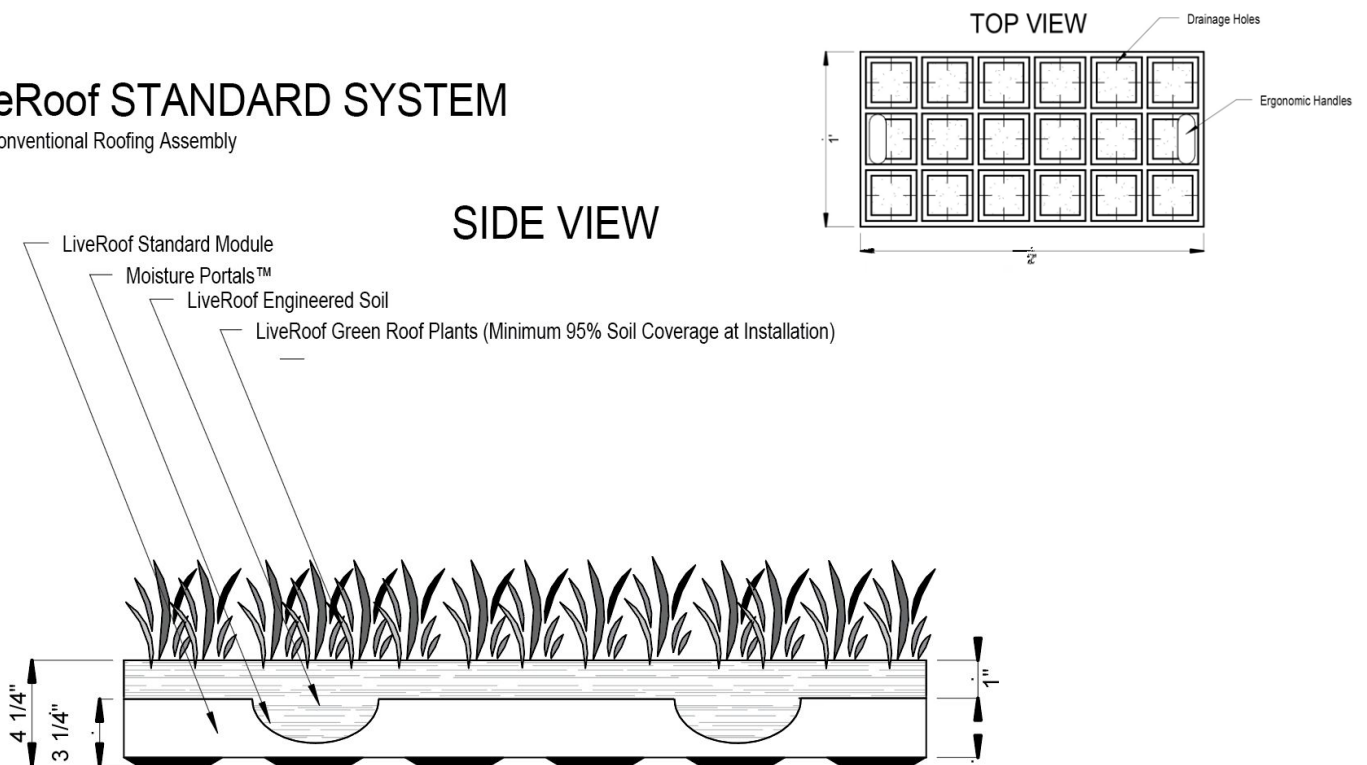

### STANDARD

LiveRoof System Saturated Weight: 27-29 lbs / sf

### LITE

LiveRoof System Saturated Weight: 15-17 lbs / sf



# FIRST STEPS

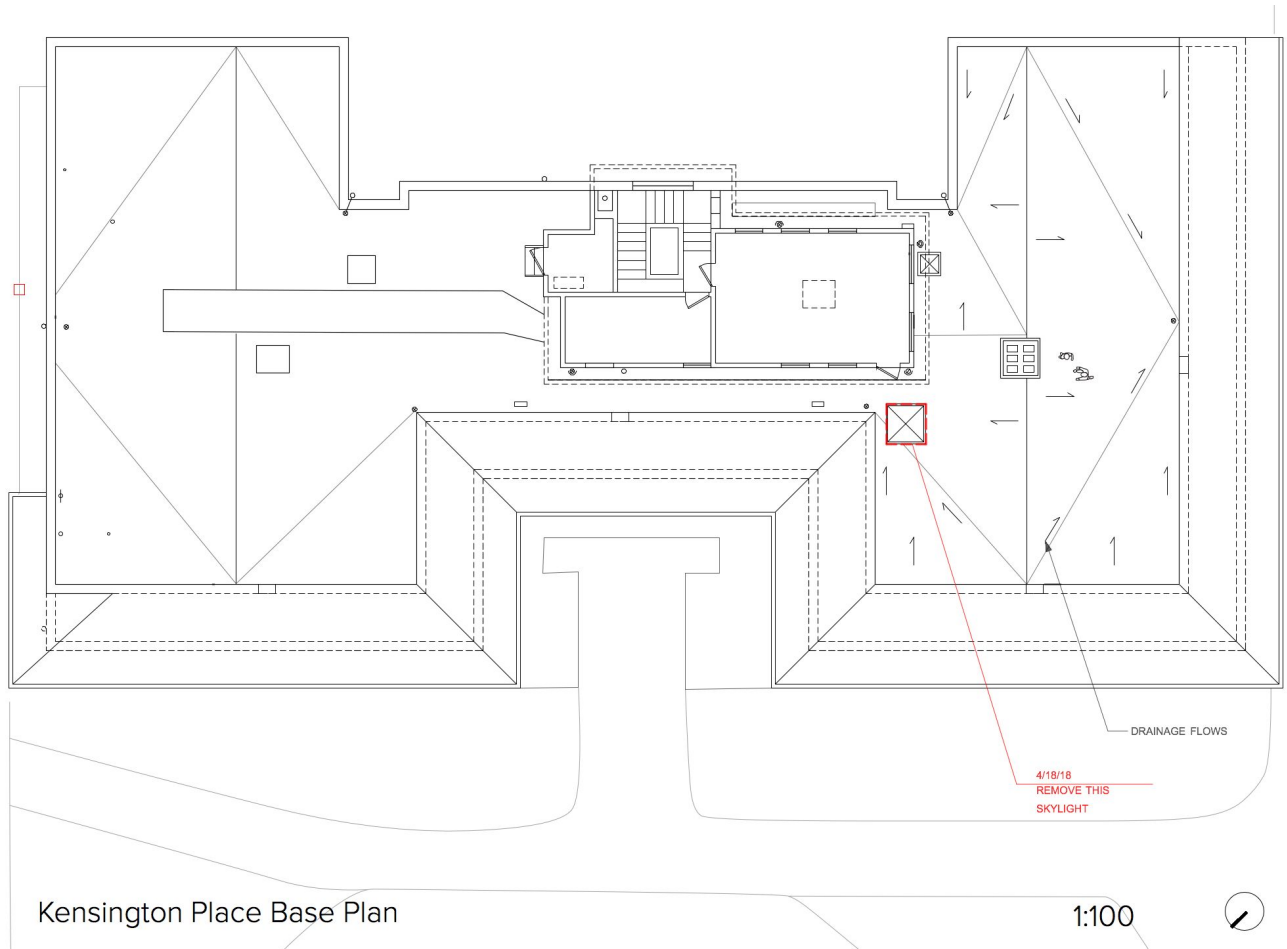

We recommend that the skylight (location indicated on the base plan) is removed during the roof replacement stage to allow for easier and safer access to the new decking area.

Custom elevated deck and live roof frames are proposed to facilitate the creation of level surfaces within the peaks and valleys of the original roof design. Existing drainage pathways are maintained along with drainage points.

# MODULAR PLANTING AND DECKING

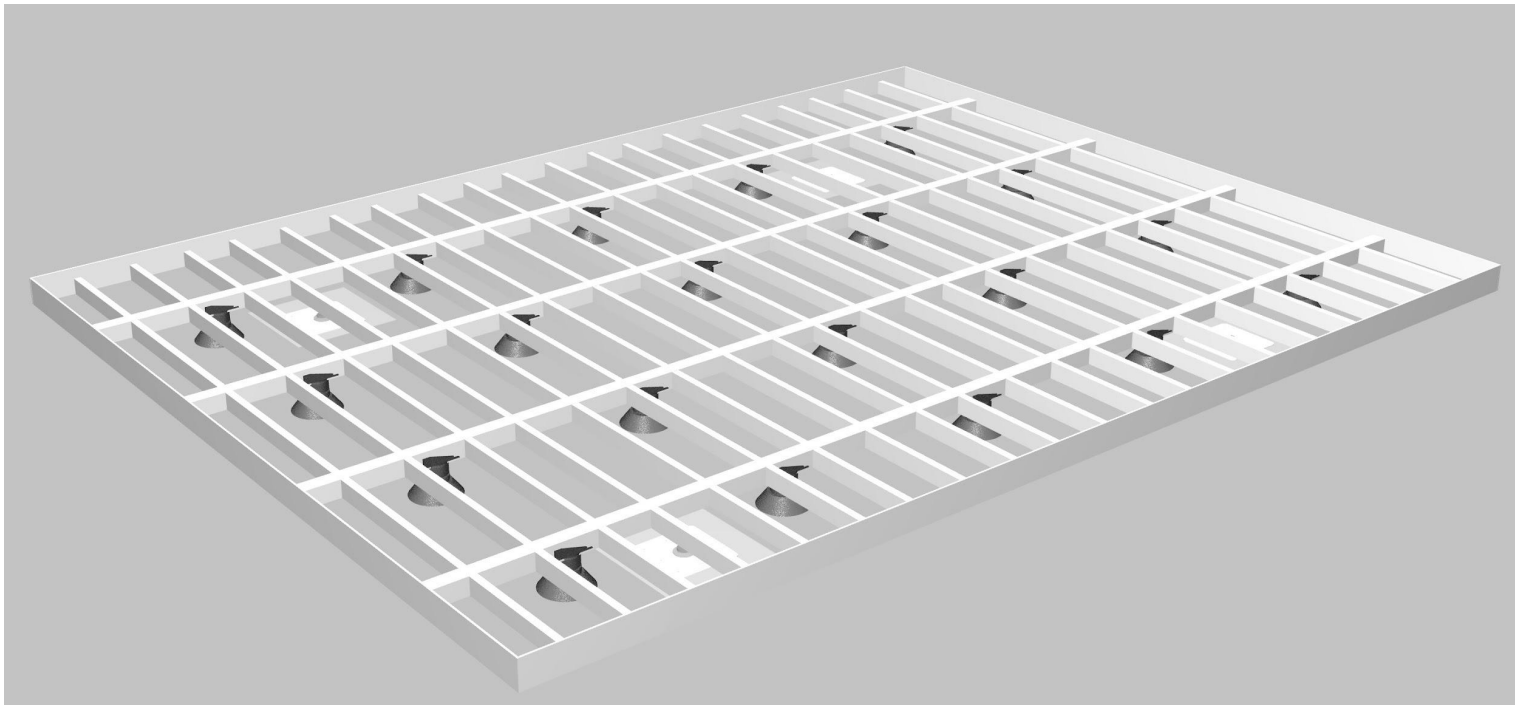

The proposed decking and planting system is modular and completely customizable.

The scale of the LiveRoof modules (1' x 2') is used to determine the proportions of the frames.

The design of the frames is essentially the same in each case (decking or live roof), and only the surface treatment changes.

We suggest aluminium as a framing material for its strength, durability, and most importantly, for its lightweight. It can be assembled on site or craned in fully assembled.

*Deck:* untreated cedar boards set on edge, tension spaced and fastened to frame with wood screws underneath, keeping topside unmarked.

*Beds:* Aluminium beams are arranged to fit to the shape of LiveRoof system modules. Wind Disk inserts help to keep modules together in high winds, and a small lip on aluminium edging adds another level of wind uplift protection.

## WindDisc™

The WindDisc is a simple way to secure LiveRoof modules together to improve wind uplift resistance. The WindDisc technology allows for any size LiveRoof modules or RoofStone pavers to connect together across a green roof installation. Please contact us for more information.



# MODULAR PLANTING AND DECKING

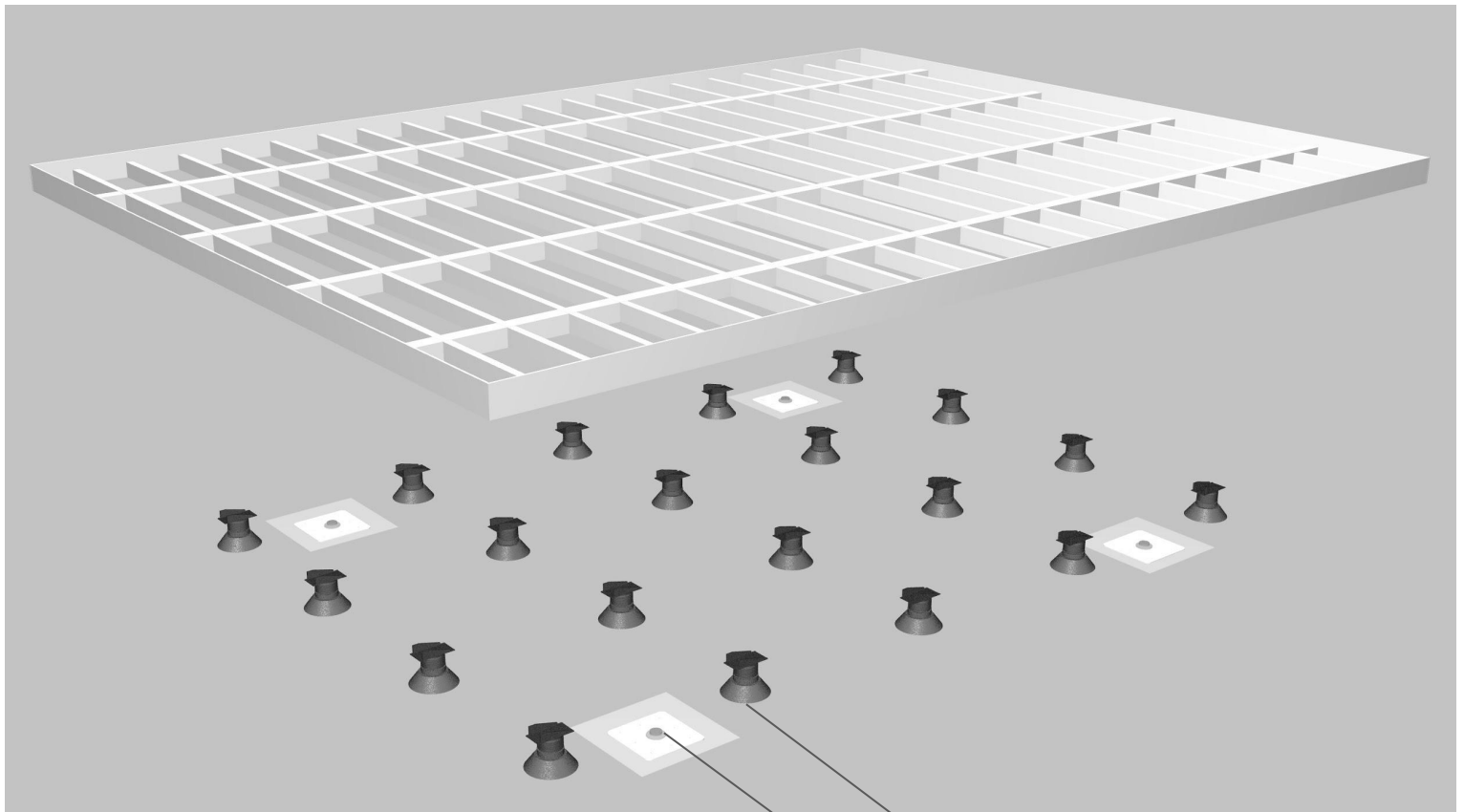

Footings

Anchor Point

Options for frame support are available either ready-made (such as the plastic version shown in the image to the left) or a custom aluminium footing could be designed and manufactured to specification. Both should be self levelling and will serve as support, but will not be attached to the roof due to the difficulty in properly sealing penetrations through the roofing membrane.

As mentioned previously, for safety reasons, the frames must be fastened to the roof to prevent movement in high winds. A custom anchoring system (see following slide) has been devised which allows for a secure attachment to the roof structure while properly sealing all penetrations, and avoiding wear and tear by not receiving direct pressure from the frame (movement from people walking, moving furniture, ...dancing?)



# MODULAR PLANTING AND DECKING: ANCHOR

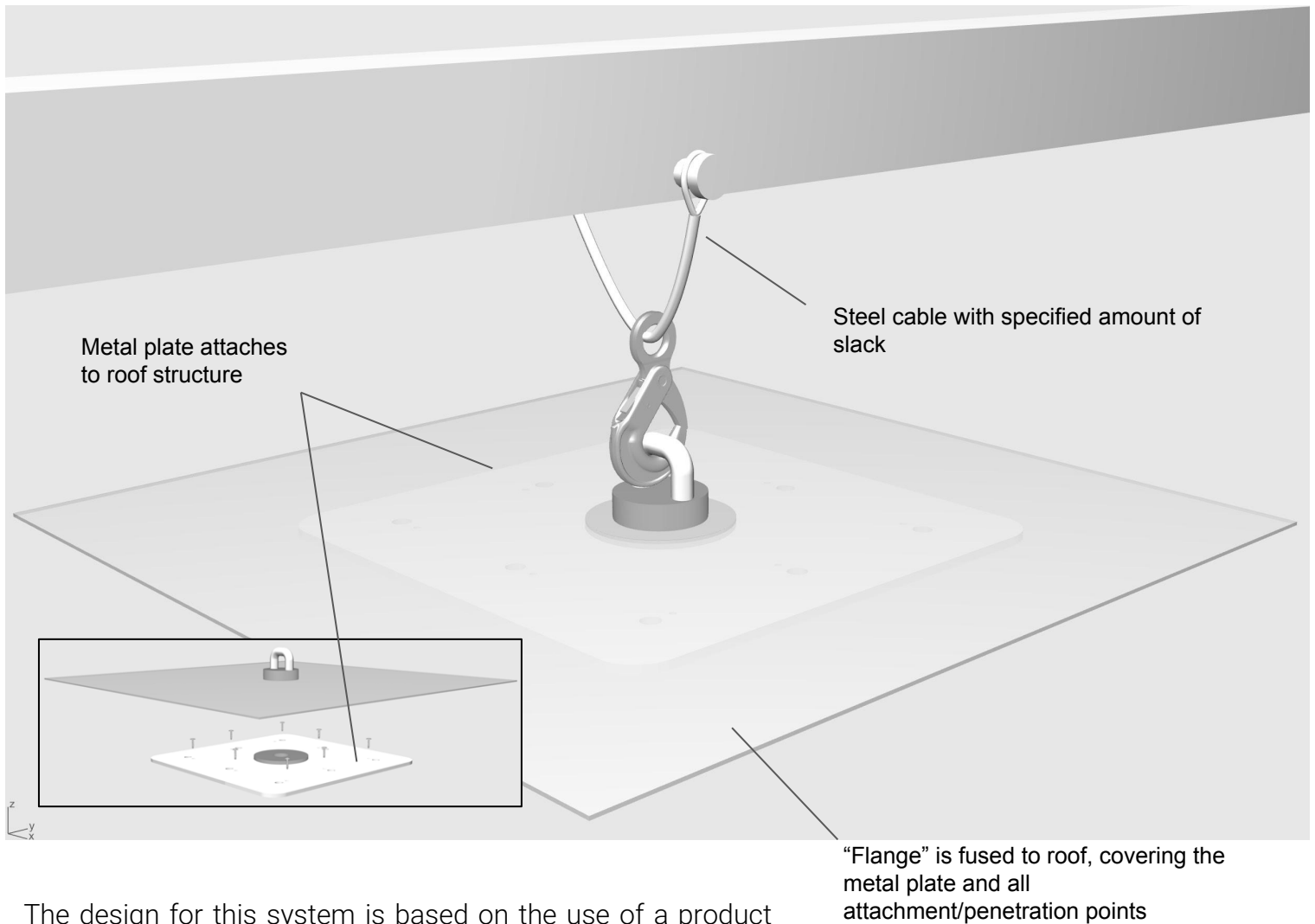

The design for this system is based on the use of a product built by NICHOLSON roof products, called ROOFTRAK™).

As per their product specs:

*-It is supplied as a factory assembled unit pre-fitted with the correct membrane enabling full integration with the roof system it is being installed on.*

*-It provides a universal fixing offering two M10 x 20 female threaded anchor points for supporting and securing most types of rails and bars. Multiple fixings can be made directly to the roofing structure providing excellent pull out values into most substrates.*

*-All the fixings are sealed under the flange of the IFP against water ingress..."*

Please visit their website for more details:

<https://www.nicholsonsts.com/products/rooftrak>

# CUSTOMIZING SPACE: 65 m2

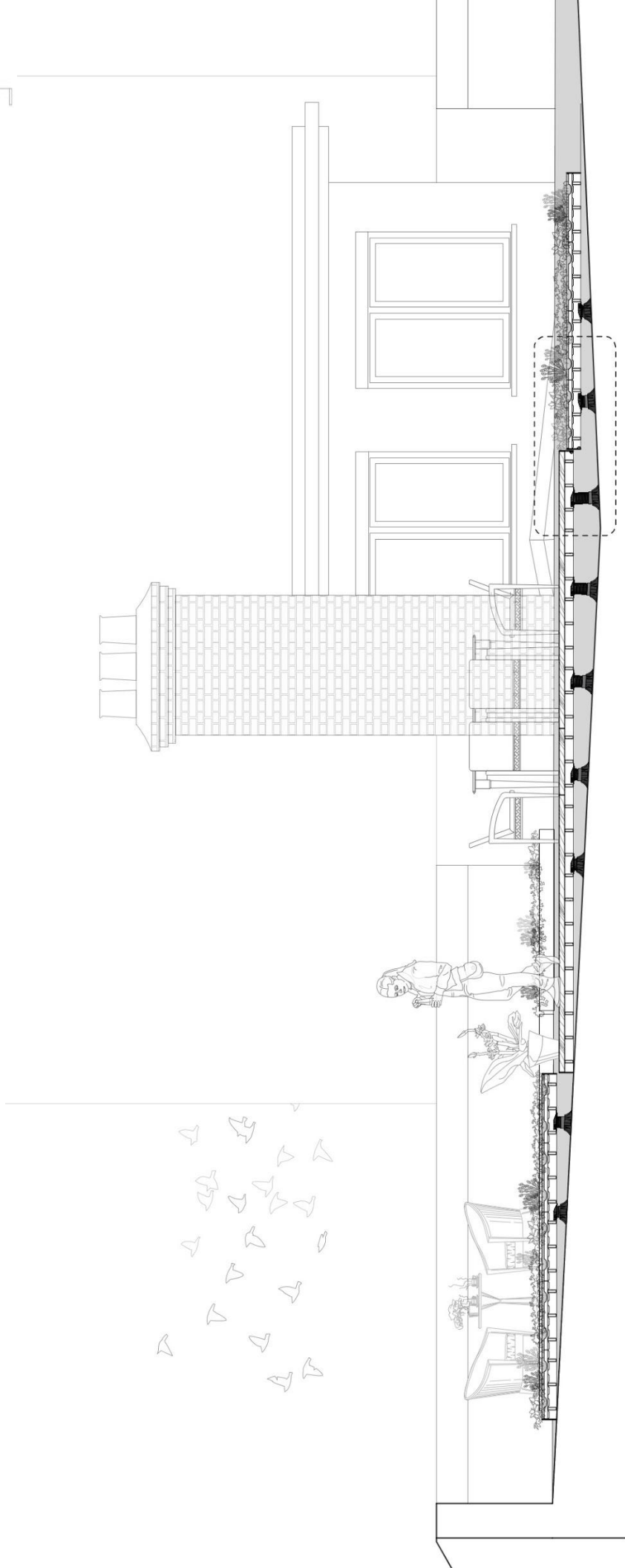
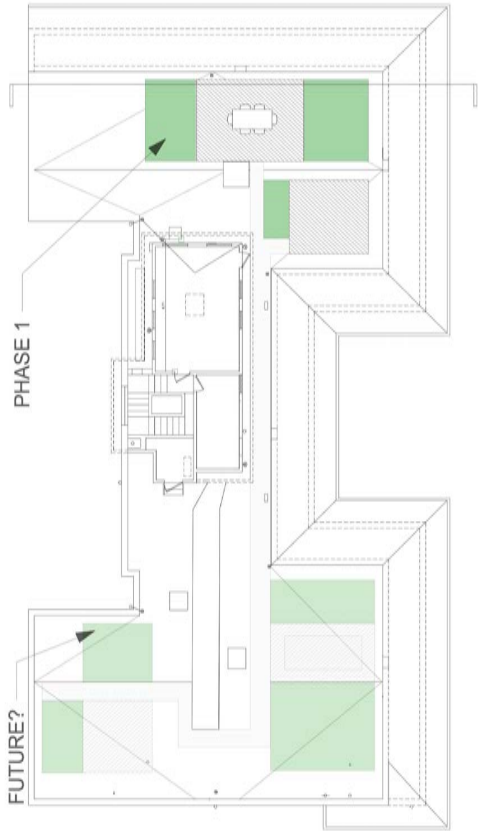

# DESIGN DETAIL

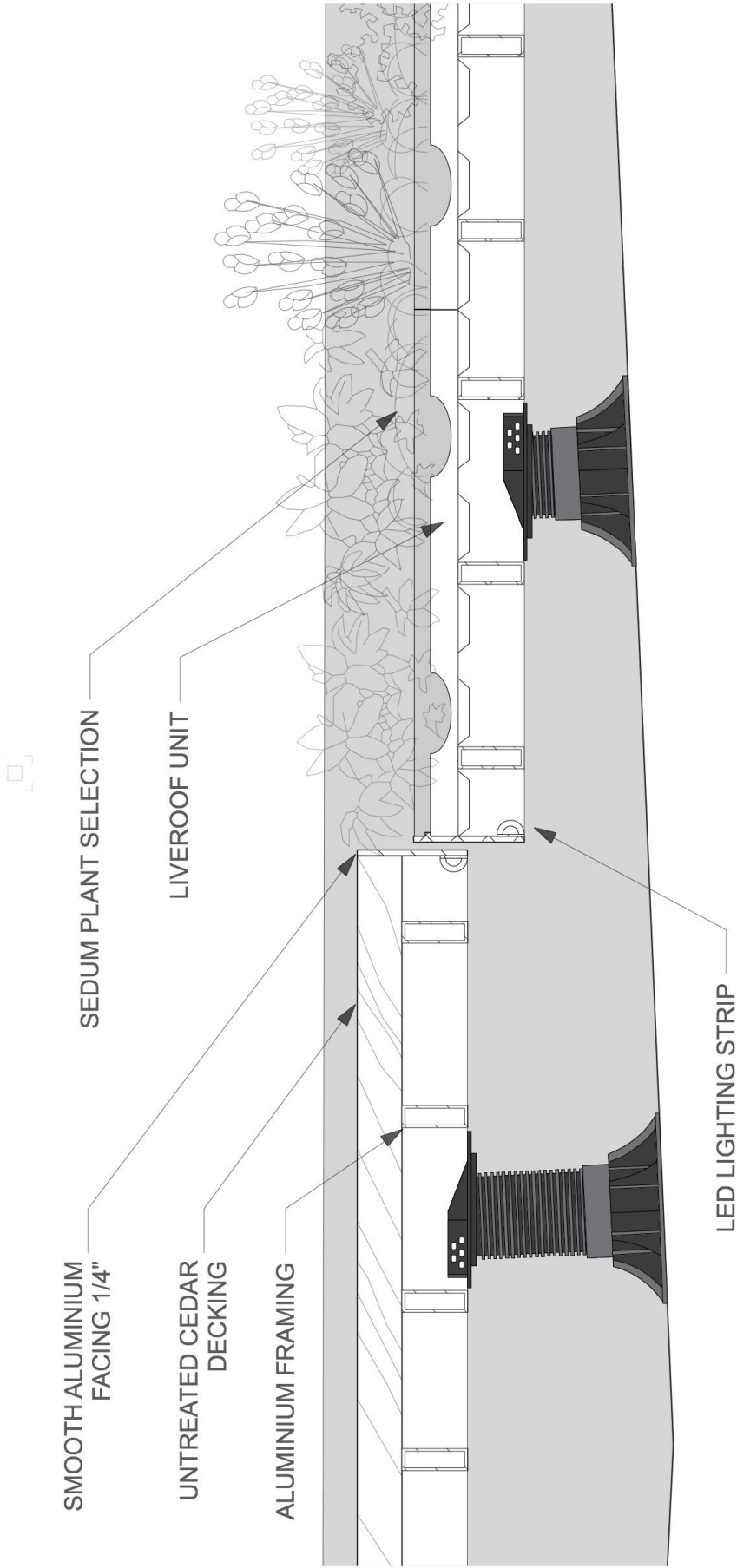



# CUSTOMIZING SPACE: 80 m2

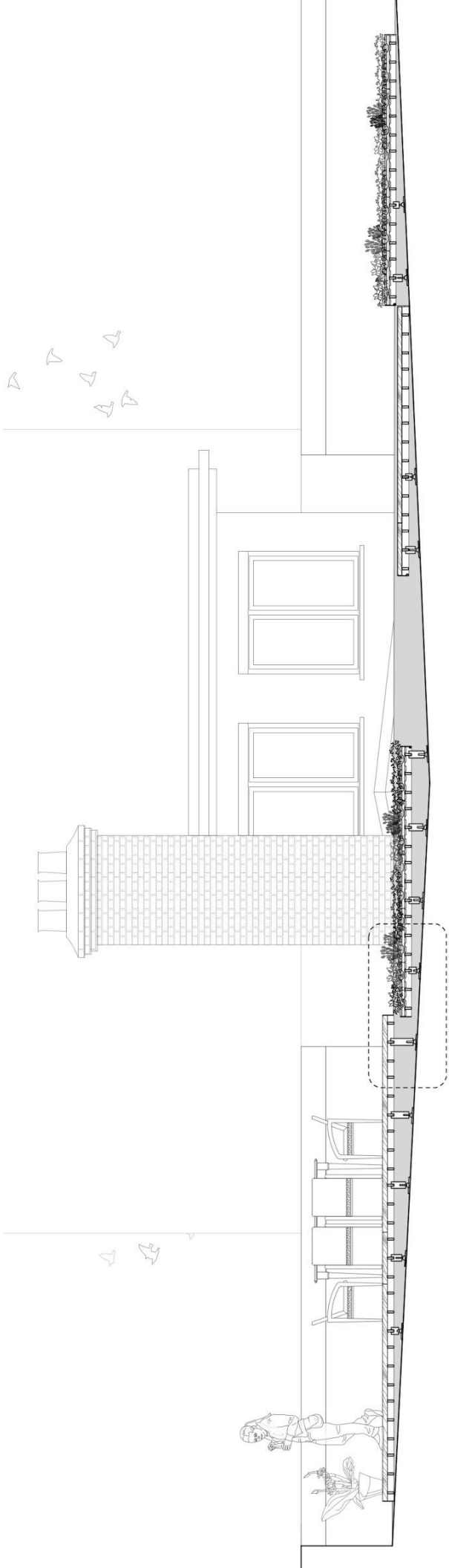
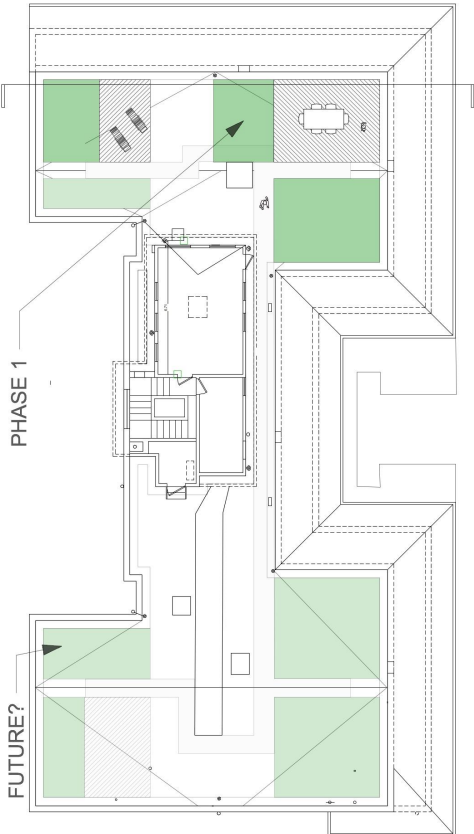

# DESIGN DETAIL

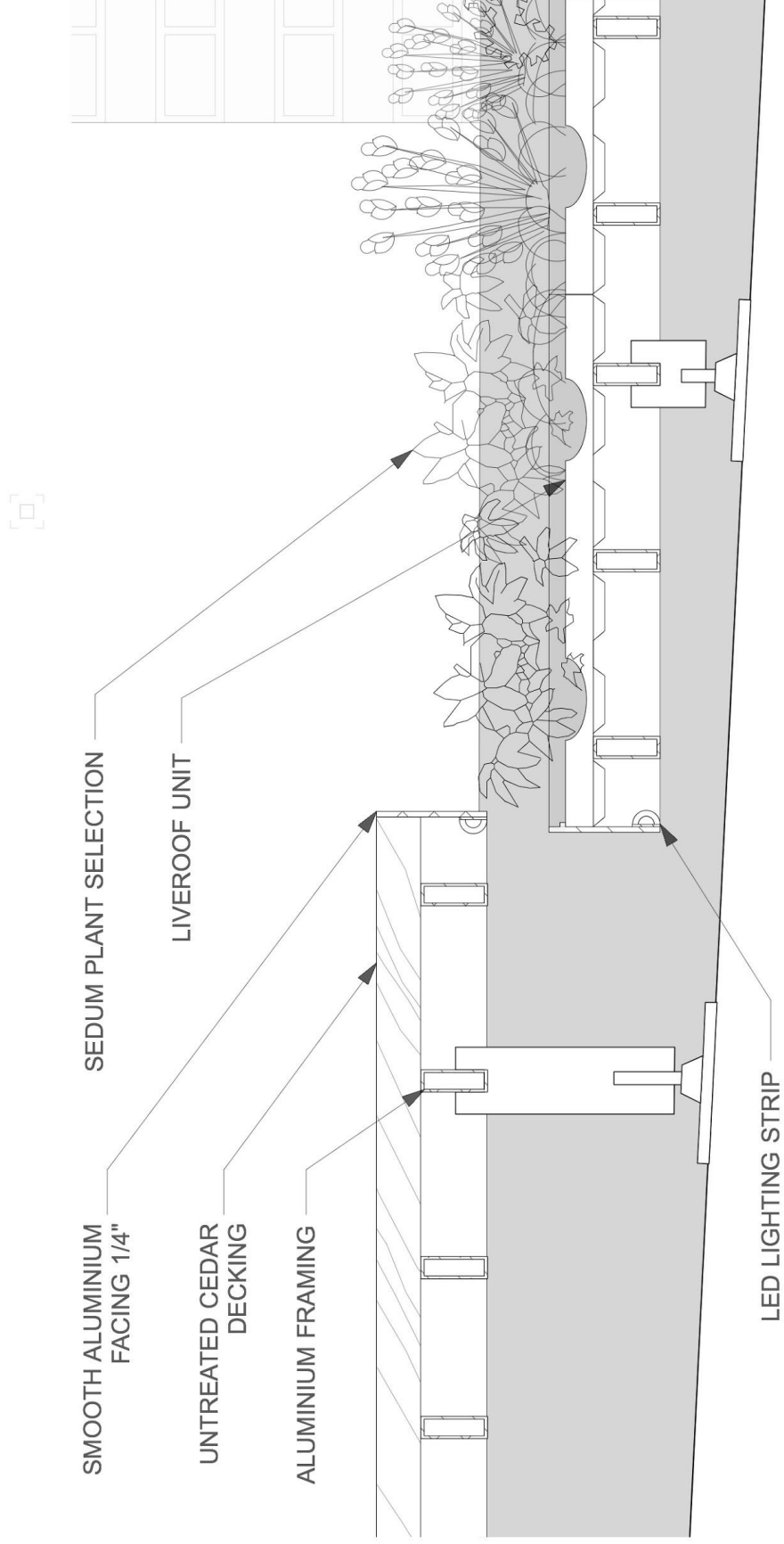

Custom aluminium footing is more costly, but lighter, longer lasting, and aesthetically customizable. After further research it was determined that a good brand of high quality plastic self levelling pedestals would be a better choice for ease of use, procurement, replacement and cost efficiency in the short term.

# FURTHER RECOMMENDATIONS: RAIN GARDEN

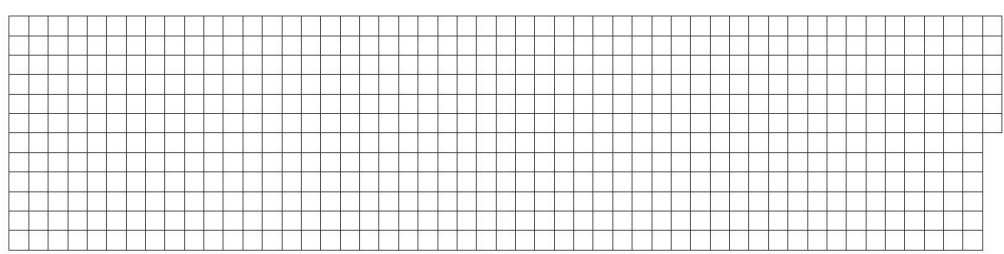
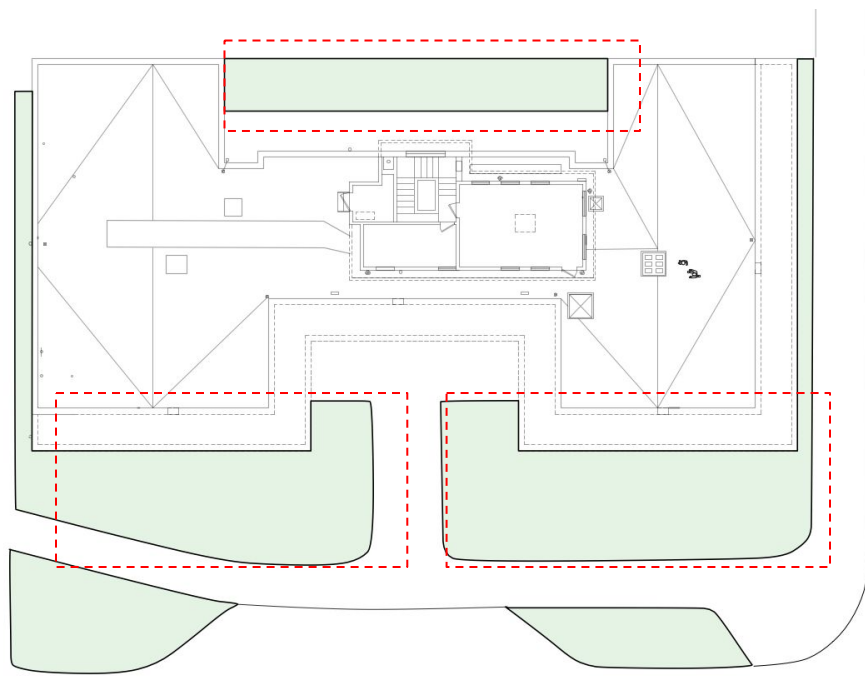

500 m<sup>3</sup>

A comparative illustration of available green space around Kensington Place, with 500 m<sup>3</sup>. All green space is currently mature landscaping (pervious). Rain gardens should be considered in the future if foundation repairs necessitate removal of current plantings. Exterior downspouts would allow for easy redirection of water. Although a full reduction of stormwater runoff would be difficult due to lack of available space on the property, we have calculated that by using 300 m<sup>3</sup> (roughly outlined in red), along with an extensive green roof installed to the preceding design guidelines (phase 1 AND future), an 85% runoff reduction could be achieved. This is equivalent to 4 large shipping containers of water cleansed and redirected into the soil, per year.

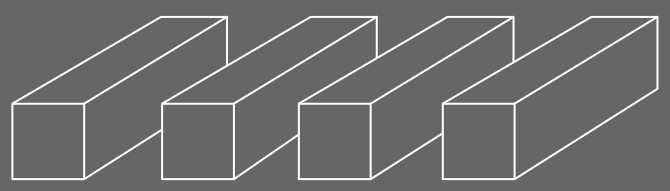



# FURTHER RECOMMENDATIONS: ROOF

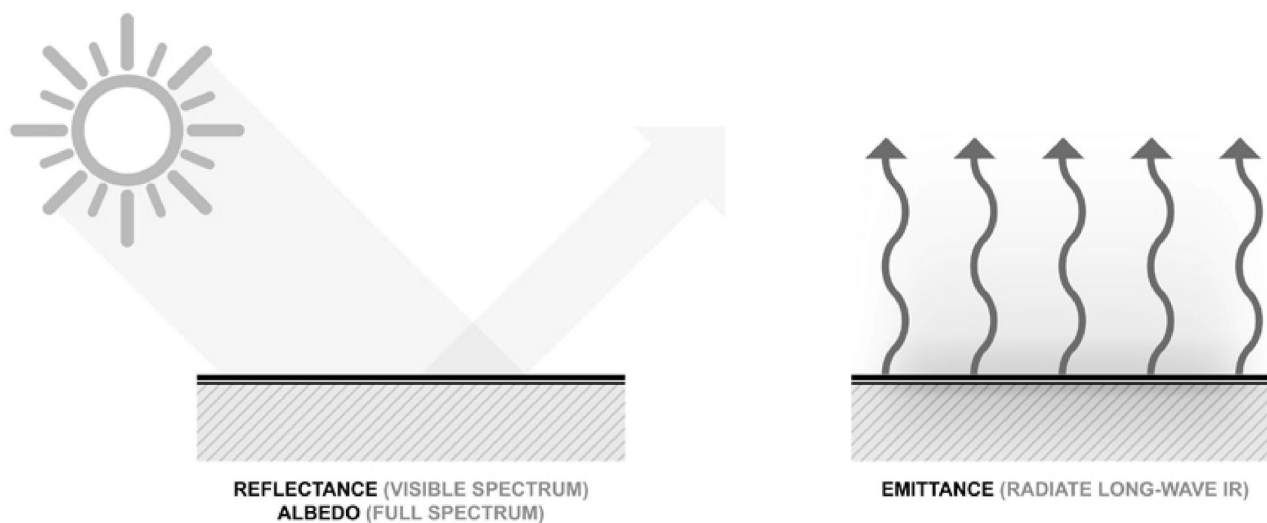

As the roof at Kensington Place is at the end of its lifespan, and will be replaced before installation of decking and gardens, there are a few details that are important to consider.

New Roofing: In order for the roof deck experience to be most enjoyable for users during the warm summer months, it will be important to consider the heat absorption and emittance of the roofing surface layer. White would be the coolest both outdoors and within the building, but may be uncomfortably bright to the eyes and for the plants. A dark surface is very heat absorptive and the remittance will create uncomfortable pockets of high heat, also drying out the air and the soil of the planters.

As the roof will not be covered completely by decking or gardens, (at least not right away) and will still be used for access, make sure to choose a neutral (beige/tan) or medium gray tone to balance light reflectivity and heat absorption/emittance.

Slip resistance is also an important factor to consider, both for the safety of users, and to allow for the footing to achieve a solid grip on the steeper slopes.

# FURTHER RECOMMENDATIONS: DRAIN AND ROOF

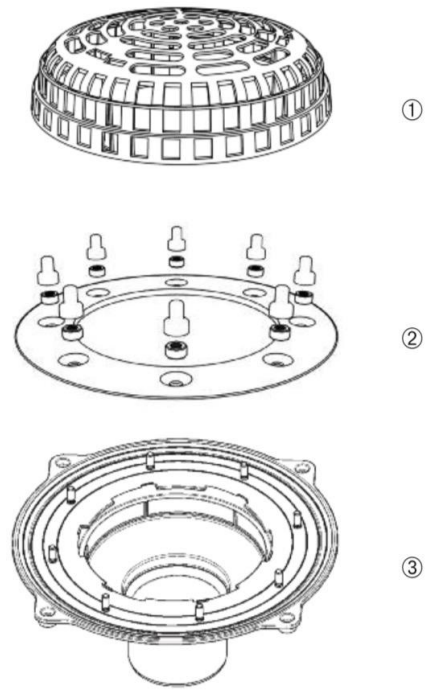

Choosing the right roof drains and overseeing their correct installation is key to avoiding expensive drainage problems like clogging, standing water and leakage.

The Ecoguss System 200 roof drain from the German brand KESSEL is a high quality flat roof drainage system which has been chosen as an example of good design. This model is customizable with modular attachments to adapt to various roofing configurations. The image to the far left demonstrates the drain coupled with an extension collar to accommodate a warm roof setup where the insulation is on the exterior of the roof.

Attachments such as the leaf trap should be included in all roof drains at Kensington Place, and the "Multistop", which prevents passage of rodents, insects and odours, is recommended for drains in close proximity to social areas.



# FURTHER RECOMMENDATIONS: DRAINS

## Installation instructions

Installation sketch:

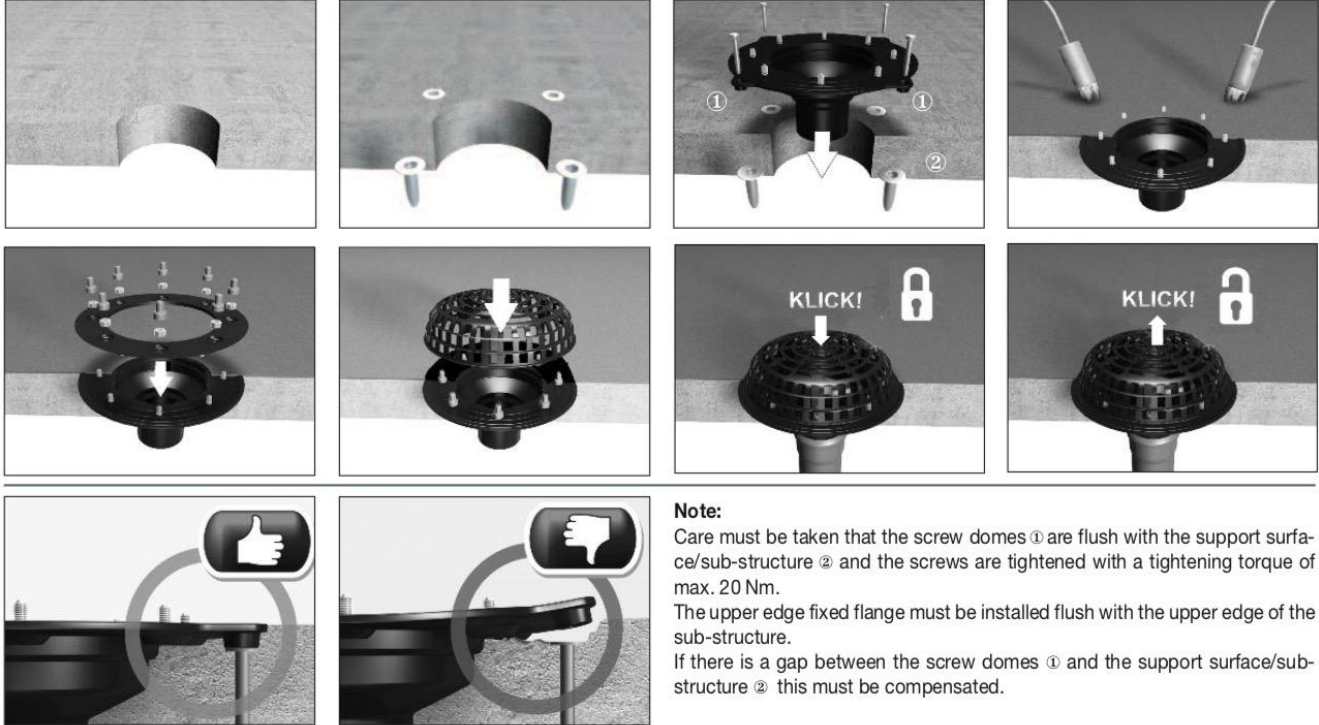

Proper installation procedures are illustrated above and must be followed exactly to ensure 100% proper functioning.

Benefits of this system:

- Easy installation
- Lightweight, corrosion free and sound dampening material
- Full selection of accessories
- Lock and lift system: no tools required for cleaning/maintenance access
- High flow performance

Visit the KESSEL website for further information:  
<http://www.kessel.com/>



4

conclusion.

# RECOMMENDATIONS

Moving forward UBC should not only consider the benefits to reduced water loads on its stormwater management systems from LID, but also the ecological benefits. Water research should continue to be an area of study for the UBC campus given its relationship to the Pacific Ocean and an eroding cliff side. Particular attention should be paid to the benefits living green roofs offer on parkades. With the opportunity to provide more public space, reduce the heat island effect, mitigate water off the ground plane and ultimately reduce waterloads on stormwater management systems this strategy is positively impacting multiple problems urban areas deal with.

Next steps would include initial documentation of parkade rooftop usage to understand car loading conditions. Identify areas of opportunity and begin implementation of one living green roof. This roof can be used for research purposes to further understand water mitigation potential while also benefiting from it. These spaces also hold the potential to become public amenities, giving the campus more than just new green space but active green space, such as venues for movies or plays or even a beer gardens for beautiful spring and summer afternoons.

# CONCLUSION

In conclusion Low Impact Design systems can be proven to work mathematically by using local weather data and established a set of variables. The UBC campus is a prime location to implement and explore this area of water mitigation and continue research around the topic. Without taking the first leap however the campus may never know the benefits that could potentially be reaped.

While green roofs have proven to be impactful in many areas water mitigation is still a new subject and is constantly being explored. The more we understand plants, soil and other aspects of our natural environment the better we can understand how to work with those systems and positively contribute to them. Low Impact Design is the first step to achieving these goals.



# GLOSSARY

**Definitions:** from : Living Roofs in Integrated Urban Water System by Daniel Roehr and Elizabeth Fassman-Beck

**Curve Number (CN):** a factor used in the Technical Release (TR)-55 method (colloquially known as the CN method) to determine runoff flow characteristics. The CN is a quantitative representation of the relationship between land use, soil type and conditions as they relate to water movement, and the resultant potential for runoff to be generated from a given magnitude of rainfall. The CN method is used in water resource planning and in stormwater management manuals by numerous jurisdictions throughout North America and Oceania.

**Evapotranspiration (ET):** the simultaneous release of water from plants and evaporation of moisture from soil or growing medium. On a living roof, ET is the process by which the assembly dries, or “empties” stored water (retained rainfall), thereby enabling the system to capture the next rainfall event. ET influences the extent to which consecutive storm events may be retained, or partially retained by a living roof system, as well as the overall appearance and health of the plant community. Potential ET is the theoretical rate at which water loss should occur if water were readily available, and is often determined using models derived from agricultural applications. In a living roof environment, the rate of actual ET is strongly influenced by the amount of (usually limited) water present in the growing media at any given time.

**Field capacity:** the maximum amount of water that a soil or growing medium can store against gravity drainage. It is usually determined as moisture content per unit depth of media.

**Crop Coefficient (Kc):** The single crop coefficient approach is used to express both plant transpiration and soil evaporation combined into a single crop coefficient. (Farg et al.)

**Living roof, extensive:** a single or multilayered living roof system (drainage, growing media and plants) designed individually or as a composite, manufactured system. The growing media depth may be 25–150mm, while the surface may be either level or graded with low topographic features. Extensive living roofs are vegetated with typically low-growing plants.

**Living roof, intensive:** a multi-layered system (drainage, growing media and plants) designed individually or as a composite, manufactured system. The substrate depth is 150mm or more, either levelled or with variable topographic features. Although they are vegetated, they may also incorporate hard landscape features like paving and structures like pergolas. Vegetation allows and includes the whole palette of plants from herbaceous plants, to shrubs and trees.

# GLOSSARY

**Definitions:** from : Living Roofs in Integrated Urban Water System by Daniel Roehr and Elizabeth Fassman-Beck

**Living roof, intensive:** a multi-layered system (drainage, growing media and plants) designed individually or as a composite, manufactured system. The sub-strate depth is usually 150mm, either levelled or with variable topographic features. Although they are vegetated, they may also incorporate hard landscape features like paving and structures like pergolas. Vegetation allows and includes the whole palette of plants from herbaceous plants, to shrubs and trees.

**Living roof, inverted assembly:** the living roof assembly type in which the insulation is installed above the waterproofing membrane. Water drains through the growing medium. A portion of the water then runs above the insulation to the drainage points. The remaining water drains vertically through the gaps between the insulation layer boards, and then runs above the waterproof membrane to drain locations.

**Living roof, warm assembly:** the living roof assembly type in which the insulation layer is below the waterproofing membrane. Water drains through the growing medium and runs along the drainage layer that sits on the waterproofing membrane to the roof drain locations.

**Low impact development (LID):** a land (re-)development approach that works with nature to minimize impacts on or improve receiving environments by managing stormwater as close to the source as possible. LID incorporates a combination of land use planning and engineered SCMs, with a preference for green infrastructure over grey infrastructure. Technically and quantitatively, LID (and GSI) seeks to maintain or restore the pre-development hydrologic cycle and minimize pollutant discharges.

**Peak flow:** the maximum stormwater runoff flow rate for a given storm event.

**Stormwater runoff:** in urban environments, precipitation that is not soaked (infiltrated) into the ground, evaporated from surfaces, transpired by plants, or harvested for reuse becomes stormwater runoff.

# REFERENCES

- References page 14 City of Vancouver. 2007. Vancouver Food Charter. Retrieved from [http://vancouver.ca/files/cov/Van\\_Food\\_Charter.pdf](http://vancouver.ca/files/cov/Van_Food_Charter.pdf) City of Vancouver. 2009.
- Urban Agriculture Design Guidelines for the Private Realm. Retrieved from <http://vancouver.ca/files/cov/urban-agriculture-guidelines.pdf> City of Vancouver. 2010.
- Rezoning Policy for Sustainable Large Developments. Retrieved from <http://bylaws.vancouver.ca/bulletin/R019.pdf> City of Vancouver. 2011.
- Greenest City Action Plan. Retrieved from <http://vancouver.ca/files/cov/Greenest-city-action-plan.pdf> City of Vancouver. 2013.
- Vancouver Food Strategy. Retrieved from <http://vancouver.ca/files/cov/vancouver-food-strategy-final.PDF> City of Vancouver. 2014.
- A Healthy City for All. Retrieved from <http://vancouver.ca/files/cov/Healthy-City-Strategy-Phase-2-Action-Plan-2015-2018.pdf> City of Vancouver. 2016.
- Urban Agriculture Policy for Parks. Retrieved from <http://vancouver.ca/people-programs/urban-agriculture-policy.aspx>.
- Fox, Jim. 2013. *How to Buy the Right Plants, Tools, and Garden Supplies*. Portland: Timber Press.
- Gorgolewski, M., J. Komisar, and J. Nasr. 2011. *Carrot City: Creating Places for Urban Agriculture*. New York: Random House.
- Hager, M. and J. Lee. 2013. Explosive growth of Vancouver's urban gardens prompts confrontations. Retrieved from <http://www.vancouver.sun.com/life/explosive+growth+vancouver+urban+gardens+prompts+confrontations/8755855/story.html>.
- McClintock, N.. 2010. Why farm the city? Theorizing urban agriculture through a lens of metabolic rift.
- Regions, Economy and Society. 3:191-207. Metro Vancouver. 2011. Regional Food Systems Strategy. Retrieved from <http://www.metrovancouver.org/services/regional-planning/PlanningPublications/RegionalFoodSystemStrategy.pdf> Metro Vancouver. 2016.
- Regional Food Systems Action Plan. Retrieved from <http://www.metrovancouver.org/services/reg>
- Daniel Roehr. *Living Roofs in Integrated Urban Water Systems*. Lecture, UBC.
- Daniel Roehr, and Elizabeth Fassman-Beck. *Living Roofs in Intergrated Urban Water Systems*. Routledge, 2015.
- Farg, E., et al. "Estimation of Evapotranspiration ETc and Crop Coefficient Kc of Wheat, in South Nile Delta of Egypt Using Integrated FAO-56 Approach and Remote Sensing Data." *The Egyptian Journal of Remote Sensing and Space Science*, vol. 15, no. 1, June 2012, pp. 83–89. *ScienceDirect*, doi:10.1016/j.ejrs.2012.02.001.
- "List of Heritage Buildings in Vancouver." *Wikipedia*, 30 Dec. 2017. *Wikipedia*, [https://en.wikipedia.org/w/index.php?title=List\\_of\\_heritage\\_buildings\\_in\\_Vancouver&oldid=817790459](https://en.wikipedia.org/w/index.php?title=List_of_heritage_buildings_in_Vancouver&oldid=817790459).
- LiveRoof® « NATS Nursery Ltd. <http://natsnursery.com/live-roof/>. Accessed 18 Apr. 2018.
- Monica Vogt. "Green Roofs in North America: Selecting Suitable Plants for the North American Climate." *Spacing Magazine*, 2015. <http://spacing.ca/vancouver/2015/12/14/green-roofs-the-north-american-context/>.
- "Native Plants for Green Roofs." *Farm Management Canada*, 7 Feb. 2012, <https://fmc-gac.com/health-environment/native-plants-for-green-roofs/>.
- Neal La Montagne. *Living Roofs at UBC LARC 582E*. Client Lecture, UBC.
- *Urban Hydrology for Small Watersheds TR-55*. USDA, 1986.