

**Power Factor Improvement**

**Nazanin Houshmand**

**University of British Columbia**

**EECE 496**

**May 13, 2013**

*Disclaimer: "UBC SEEDS provides students with the opportunity to share the findings of their studies, as well as their opinions, conclusions and recommendations with the UBC community. The reader should bear in mind that this is a student project/report and is not an official document of UBC. Furthermore readers should bear in mind that these reports may not reflect the current status of activities at UBC. We urge you to contact the research persons mentioned in a report or the SEEDS Coordinator about the current status of the subject matter of a project/report".*

THE UNIVERSITY OF BRITISH COLUMBIA  
Department of Electrical and Computer Engineering



# **Power Factor Improvement**

By: Nazanin Houshmand

Student number: XXXXXXXXXX

Supervisor: Dr. Andre Ivanov and Dr. Paul Lusina

## **ABSTRACT**

This project investigates power factor improving equipment for the following buildings on UBC campus: Life Science, Biology West, Chemistry Physics, Forest Science and Michael Smith. My objective throughout this project was to write a Microsoft Excel program that would be able to calculate the capacitor values needed to improve the power factor, and increase the life span of the transformer due to the addition of the equipment. Additionally, the program enables users to calculate the amount of yearly savings, based on the installation of the capacitors and the savings resulting by the reduction of greenhouse gas emissions, given the real power as well as the power factor. This report will discuss the different aspects of the project, such as the equipment and methodology, and the calculations and results. In the end, I was able to complete my goal of creating a Microsoft Excel file that will calculate all the necessary information for future projects as well as recommending corrective equipment for each building. The Microsoft Excel program can easily be extended to include calculations of value of money and the possible repair cost.

## TABLE OF CONTENTS

Abstract.....	ii
List of Tables.....	iv
List of Figures.....	v
List of Equations.....	vi
Glossary.....	vii
1.0 Introduction.....	1
2.0 Equipment and methodology.....	3
3.0 Designs and Experiments.....	4
3.1 Harmonics.....	4
3.2 Capacitor Location.....	5
3.3 Financial Savings.....	6
3.4 Equipment Life Cycle Impact.....	7
4.0 Results.....	10
4.1 Closest capacitor.....	10
4.2 Filter and breakers.....	11
4.3 Savings.....	12
4.4 Break Even Point.....	13
4.5 Life Improvement.....	13
5.0 Conclusion.....	15
References.....	16
Appendix.....	17

**LIST OF TABLES**

Table 1: Summary of advantages/disadvantages of different combination of capacitors.....5

Table 2: BC hydro electrical charges.....7

## LIST OF FIGURES

Figure 1: Capacitor location on motor circuit.....	6
Figure 2: Loss characteristics for electrical core-steel materials over a range of magnetic induction.....	8
Figure 3: Closest Capacitor Value.....	10
Figure 4: Switched harmonic filter and breaker (\$).....	11
Figure 5: Yearly savings (\$) of addition of capacitors.....	12
Figure 6: Breakeven point in number of months.....	13
Figure 6: Life of the transformer after the addition of the capacitors.....	14

## List of Equations

Equation 1: Relationship between Apparent power and power factor.....	4
Equation 2: Harmonics equation.....	5
Equation 3: Power rating ratio.....	8
Equation 4: Equation known as per unit life .....	9

## GLOSSARY

Microsoft office Excel	Microsoft program used usually for accounting to calculate formulas for large data
Real Power	The power that is used to do work on the load in units of Watts.
Reactive Power	Power merely absorbed and returned in load due to its reactive prosperities in units of VAR
Apparent Power	The power supplied to the system in units of VA
Power factor	The ratio of the real power flowing through the load to the apparent power in the circuit
GHG	Green House Gas emissions are any of the atmospheric gases that contribute to the greenhouse effect by absorbing infrared radiation produced by solar warming of the Earth's surface. They include carbon dioxide (CO <sub>2</sub> ), methane (CH <sub>4</sub> ), nitrous oxide (NO <sub>2</sub> ), and water vapor.



## 1.0 INTRODUCTION

This project investigates the possibility of saving both energy and capital by adding corrective capacitors. Furthermore, this project has all the calculations formulated so that it can be easily accessed for future projects, and generate the required information by only changing the initial data.

My objective during this project is to evaluate possible equipment that can be used to reduce reactive power usage by improving power factor, while being cost efficient. In order to discover the installation cost, I used Microsoft Excel to calculate the capacitor value needed to improve the power factor to 90%, 95%, and 100%. I then found the breakeven point by means of the total electrical and GHG emission savings.

BC Hydro charges UBC for the amount of reactive power used by the transformers located at each building. The electricity bill can be reduced by decreasing the reactive power used by the transformers; this is the direct result of the transformer's power factor improvement. Motor productivity and life span of the transformers will also increase due to the addition of capacitors to the circuit and the raised voltage level. Additionally, this project will help UBC's sustainability team in accomplishing their goal of reducing campus's greenhouse gas (GHG) energy emissions.

This project involves great knowledge of Microsoft Excel as well as energy flow in the system. I had to learn various functions in Microsoft Excel to ensure the calculations can be easily used for future projects. I also had to learn about power ratings and per unit life in order to be able to calculate the life expectancy improvement of the transformers from the addition of the bulk of

capacitors. I also learned about the importance of harmonics in selecting capacitor types for individual buildings.

I was able to accomplish all my objectives including calculating capacitor value, corrective equipment analysis, and financial gain from the installation of such equipment. Furthermore, I investigated the life expectancy enhancement using the thermal temperature reduction due to the increase in power factor. Given the short period of time, I was not able to account for the change in value of money and increase in the electricity charges that may occur in the future. However with the knowledge of net future value, and net present value, it can be easily formulated into Microsoft Excel during future projects.

This report divides into the following primary sections: Equipment and Methodology, Designs and experiments, Results, and Conclusion.

## **2.0 EQUIPMENT AND METHODOLOGY**

Upon discussing the purpose and objective of the project with Dr. Paul Lusina, we decided to use Microsoft Excel for all the calculations needed throughout this project. The decision was mainly due to Microsoft Excel's calculation flexibility for large amounts of data as well as the program being future user friendly due to formulated cell sheets.

I approached this project with the idea of comparing the present transformer usages to the values of the ones found after the addition of capacitors. During the term, Dr. Lusina and I have had weekly meetings to discuss the essential information needed to select a capacitor, as well as to estimate the total annual savings due to the addition of the equipment. In order to find the capacitor values and the savings as a result of the addition of capacitors we have concluded that the following information is necessary: active power, reactive power, apparent power, and present power factor, coldest and hottest temperature of the system, thermal resistance, the core material's dimension, and electricity charges.

Given that two of the buildings in this project have more than one transformer, life science having three, and forest science having two transformers, it would be difficult to show all the information on one page. In order to make the comparison easier, each transformer has its individual work sheet, one with the information regarding capacitor values and life expectancy, and another for savings.

### 3.0 DESIGNS AND EXPERIMENTS

In order to attain the capacitor value, I first calculated the existing apparent power used by the systems via the real power and power factor measurements found from UBC Ion website.[Appendix 1] The following formula illustrates how the calculations were computed. [1]

$$\text{Apparant power} = \frac{\text{Real Power}}{\text{Power Factor}}$$

Equation 1: Relationship between Apparent power and power factor [1]

I then used the table of desired power factors in percentage to find the ratio multiplier for capacity; I used desired power factor of 90%, 95% and 100% in comparison to the original power factor. [Appendix 2] Multiplying the ratio found using the desired power factor table by the real power of the system, I was able to calculate the value of a capacitor in kVAR Since the exact capacitor value for the correction is not always commercially available, I investigated the installation charges for the closest value of capacitance to the average of the calculated values over two days of measured data.

#### **3.1 Harmonics**

Another factor that was taken into account while choosing the appropriate capacitor was the presence of third harmonics. Due to the interaction of the capacitor with the service transformer, harmonic voltages and currents are significantly magnified which is referred to as harmonic resonance. By adding on to the existing kVAR, we are increasing the likelihood of amplifying the harmonics. It is important to avoid having system harmonics, because it can result in blown fuses or fuses not working properly, as well as reduction in motor life span. The harmonics of the system was found using the formula shown on the next page. The circuit resonance will increase

enormously if the  $h$  calculated is close to the major harmonics created by the nonlinear device i.e. 1, 3, 5, etc.[2]

$$h = \sqrt{\frac{kVA_{sys}}{kVAR}}$$

$kVA_{sys}$  = Short-Circuit Capacity of the System  
 $kVAR$  = Amount of Capacitor kVAR on the Line  
 $h$  = The Harmonic Number referred to a 60 Hz Base

Equation 2: Harmonics equation [2]

### 3.2 Capacitor Location

It is not only important what value of capacitor is used, but also the type and location of installation are just as important. Table 2 indicates the advantages and disadvantages of different combinations of capacitor methods. During the project, I chose to compare the most cost efficient methods i.e. fixed banks and switched banks. [3]

Method	Advantages	Disadvantages
Individual capacitors	Most technically efficient, most flexible	Higher installation and maintenance cost
Fixed bank	Most economical, fewer installations	Less flexible, requires switches and/or circuit breakers
Automatic bank	Best for variable loads, prevents overvoltages, low installation cost	Higher equipment cost
Combination	Most practical for larger numbers of motors	Least flexible

Table 1: Summary of advantages/disadvantages of different combinations of capacitors [3]

There are four different location options for the installation of the capacitors. The four options that are shown on figure 1: directly at the single speed induction motor terminals (on the secondary of the overload relay), between the contactor and the overload relay, location A, between the upstream circuit breaker and the contactor, location B, and at the main distribution bus, location C. However the first two locations mentioned would only provide the option of installing individual capacitors. The individual capacitors are an efficient method for power

factor correction; however a high installation and maintenance cost is associated with them. Therefore, making the option of installation at either location, whether that be directly at the single speed induction motor terminals, or between the contactor and the overload relay, seem unreasonable. Additionally, having the bank of capacitors at the main distribution line, will result in possibility of overcorrection under lightly loaded conditions as well as a requirement for separate disconnect switch, and over current protection method. Concluding, the best location for the installation of the corrective equipment would be between the upstream circuit breaker and the contactor. The only disadvantage for the selected location of installation is the possibility of overcorrection occurring if all motors are not running. [4]

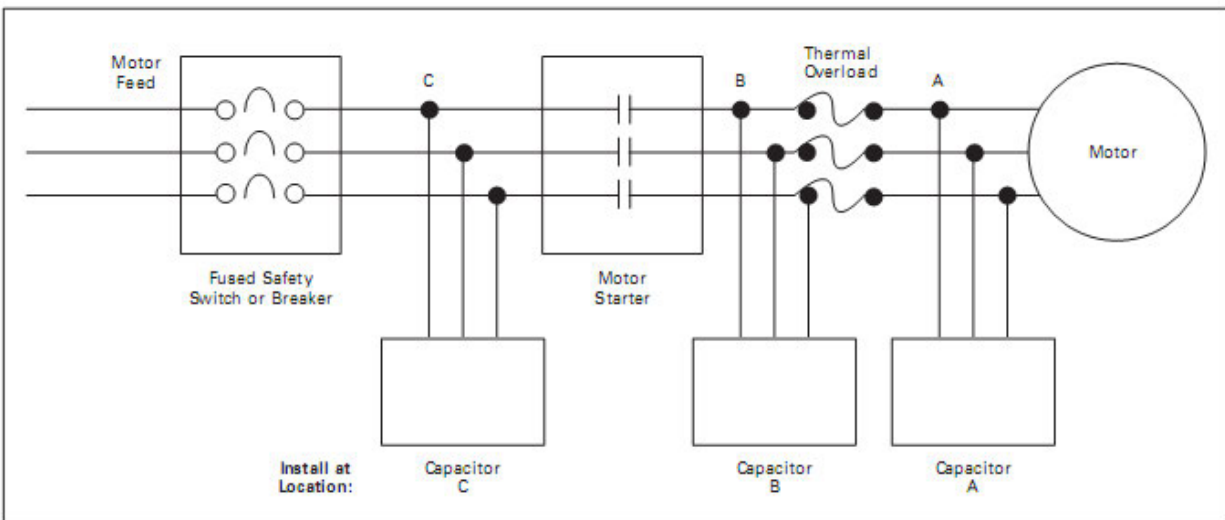

Figure 1: Capacitor location on motor circuit [4]

### **3.3 Financial Savings**

To explore the total savings as a result of the addition of the new equipment to the circuit, I had to inspect the original electrical charges of the system. UBC’s Ion system indicates the measured data in 15 minutes intervals. After finding the kVAR of the system and integrating it over 15 minutes for the month of February, I was able to calculate the month’s electrical charges using

the information given in table 2. The electrical charge is the multiplication of the total integration of kVAR of the system by the energy charges, added to the multiplication of the peak value of the integration of kVAR by the demand charges. The rate rider and tax is then added to the charges from the previous step.

<b>Electric Rate Schedule</b>	<b>Charges</b>
Energy (\$/kWh)	\$0.03814
Demand (\$/kVA, monthly)	\$6.507
Applicable Taxes (7.40 % for PST & ICE fund levy + 1.65% for GST)	9.05%
Rate Rider	5.20%

Table 2: BC Hydro electrical charges

Using the new kVAR due to the new power factor, the electrical charges for the new system can be easily calculated. UBC is also responsible for the Green House Gas emission of electricity which has the electric rate of \$625/GWh. By calculating the difference of the total bill for the original system and the improved system, and adding the GHG savings enabled me to estimate the total monthly and yearly savings. Knowing the installation costs, the breakeven point can be projected to be the installation cost divided by the total daily savings.

### **3.4 Equipment Life Cycle Impact**

In addition to the corrective equipment value and the financial savings as a result of the installation of the equipment, I also investigated the life expectancy improvement of the transformers. The most important calculation in finding the improvement of the life of the transformer is the calculation of the hottest temperature of the system after the addition of the capacitors. To accomplish the goal of finding the hottest temperature, I took advantage of the formula for the power rating of the system, which is the maximum power used within the system.

The amount of heat that can be dissipated by the transformer,  $P_{D,max}$ , is directly proportional to the amount of losses within the system; the losses of the system is simply efficiency subtracted from one. Efficiency of the system is the ratio of output energy to input energy, or the output energy plus the losses of the system. To find the losses of the system I used figure 2. The core material of the transformers used at the buildings in question are 0.3mm and are constructed from high quality, cold rolled, grain orientated, stress relieved silicon steel laminations, insulated on one side and working at a flux density not exceeding 1.73 Tesla. Therefore, the power loss in watts/kg is about 1 W/Kg and multiplying this value with the transformer's weight will result in total losses of 3800 watts. [5]

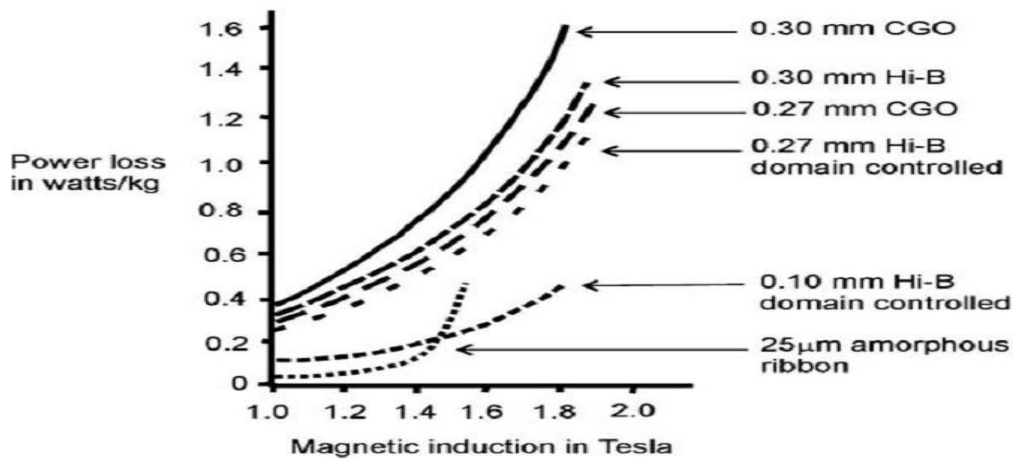

Figure 2: Loss characteristics for electrical core-steel materials over a range of magnetic induction [5]

Knowing the maximum safe operating temperature,  $T_{D,max}$ , and the ambient temperature,  $T_A$ , to be 165 and 40 respectively, and having  $P_{D,max}$  already calculated using the following information, the thermal resistance,  $\theta_{DA}$ , of the system can be found in units of  $m^2K/W$ . [6]

$$P_{D,max} = \frac{T_{D,max} - T_A}{\theta_{DA}}$$

Equation 3: Power rating ratio



The maximum temperature after the addition of the corrective capacitor was determined using the thermal resistance, and the new efficiency of the system. The life cycle of the current transformers can be assumed to be 40 years at 50% loading (ideal situation) and 25 years at 80% loading. By using per unit life formula, using the new hottest temperature calculated,  $\theta_H$ , and having constant  $B$  to be 1500, I was able to determine constant  $A$  and consequently the improvement to the life span using the new hottest temperature of the system.

$$\text{per unit life} = Ae^{\left[\frac{B}{\theta_H + 273}\right]}$$

Equation 4: Equation known as per unit life

## 4.0 RESULTS

This section presents the summary of the results for each transformer of the selected buildings on campus. I have summarized all the findings of the project into the following four tables: capacitor values and information, capacitor installation costs, financial savings and life expectancy improvements.

### 4.1 Closest Capacitor

The amount of KVA to be added in order to improve the power factor depends on the measured power factor as well as the measured real power. As it can be seen from figure 3, the better the desired power factor, the higher the added kVA of the capacitor must be. The capacitor value for Michael Smith is larger than the other buildings, because the real power consumption average of 616 kW is much greater compared to average consumption of 260 kW for the other buildings.

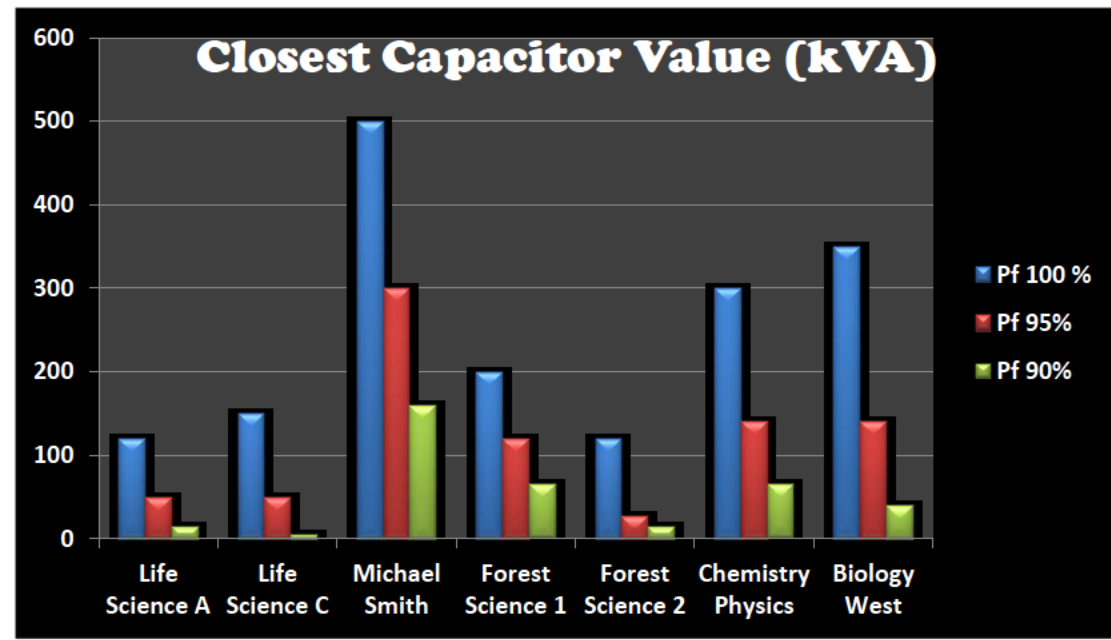

Figure 3: Closest Capacitor Value

## 4.2 Filters and Breakers

In this project I investigated four different possible capacitors that can be installed in the building's system: fixed harmonic filter and breaker, switched harmonic filter and breaker, fixed capacitor and breaker, and switched capacitor and breaker. Having the fixed capacitors would be less expensive; however, due to the fact that the capacitor is not switched with the motors, overcorrection may occur. Furthermore, the addition of a capacitor results in harmonic resonance close to the major harmonics created by nonlinear device at power factors of 95% and 100% for some of the buildings.[Appendix 2] Therefore a simple capacitor bank cannot be installed and instead we must use a harmonic filter. The cost of the switched harmonic filter and breaker is shown in Figure 4. The cost of the installation of the breaker is directly proportional to the kVA value of the capacitors being installed. The transformer for Forest Science 2 has the least cost since the capacitor value needed to improve the power factor is also less than the other buildings.

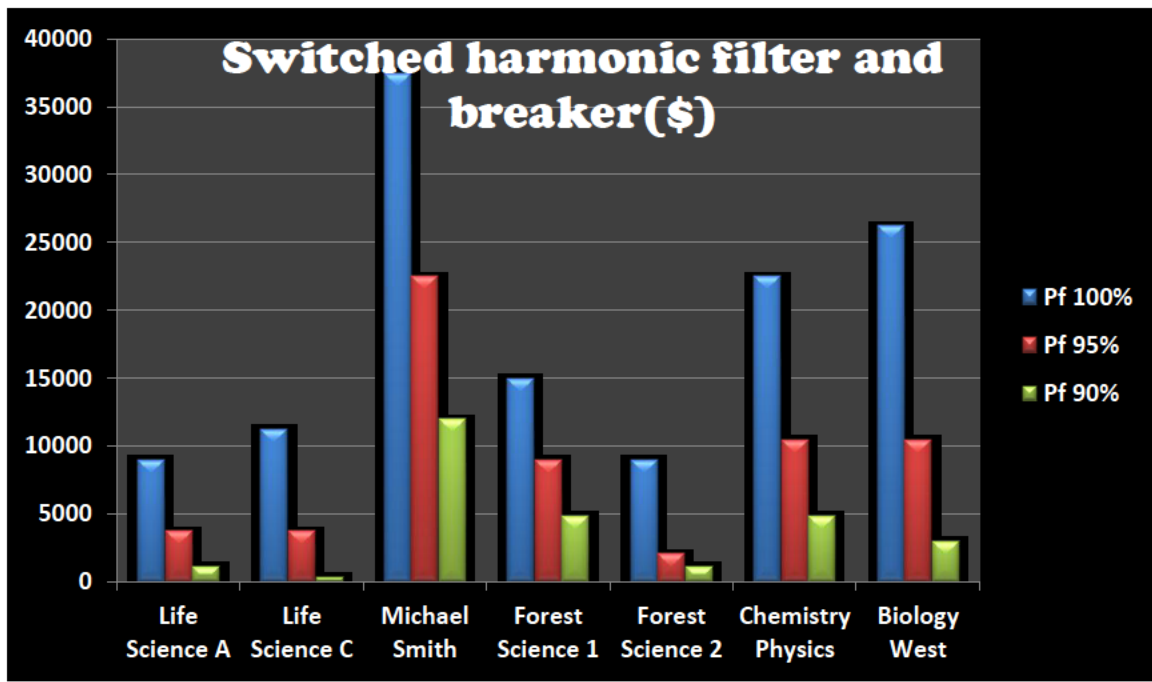

Figure 4: Switched harmonic filter and breaker (\$)

### 4.3 Savings

The total yearly electrical savings and greenhouse gas savings due to the improvements of the power factor is shown in Figure 5. The savings for a power factor of 90% for Forest Science 2 transformer and Biology West transformer is not shown due to the buildings already having power factors equal or greater than the said desired power factor. Comparing the installation cost to the yearly savings, it is clear that even though the installation of capacitor for 100% desired power factor is costly, the savings created by the installation is much greater. Depending on the initial investment, UBC should choose between 95% to 100% power factor improvements.

Unfortunately, the measurements for life science's B transformer are not available from the Ion website. Since the average power factor for Life Science A and C are very close, the recommendation for the transformer B can be assumed to be similar to the other two transformers. Therefore, the installation saving can be estimated to be between \$67642 and \$78415.

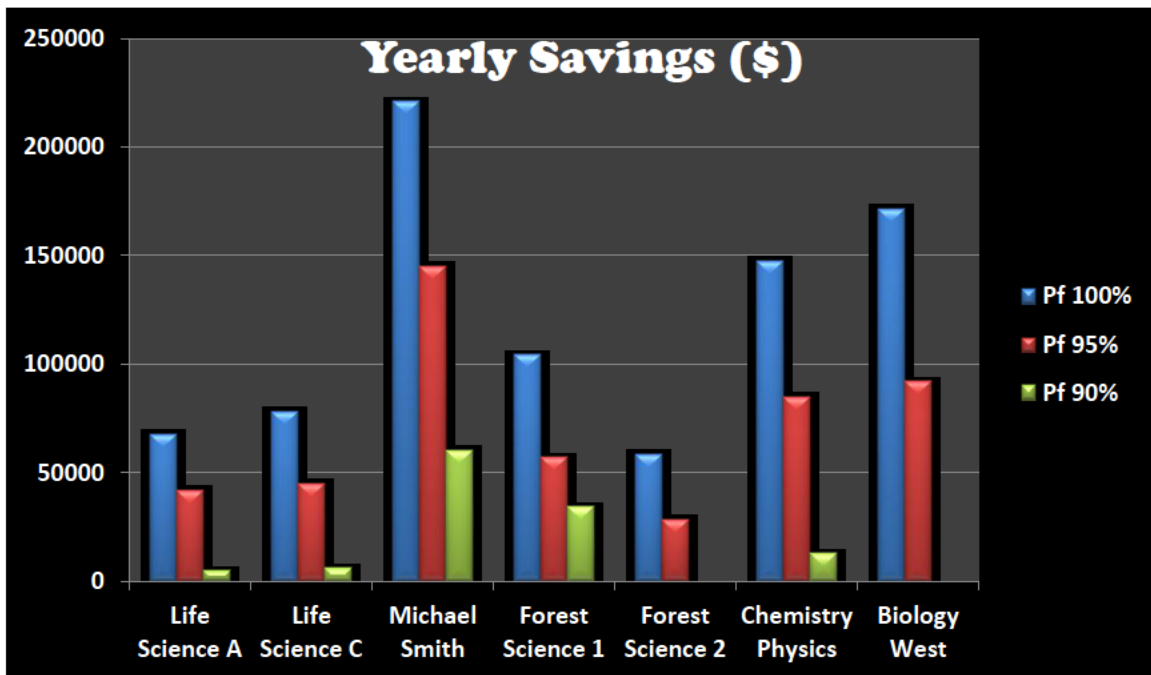

Figure 5: Yearly savings (\$) of addition of capacitors

#### **4.4 Break Even point**

Using the initial investments for switched harmonic filters and breakers, the breakeven point for the buildings in question is calculated and shown in figure 6. With the calculations from financial savings, it was concluded that the power factor improvement should be 95% or higher. Even though the desired power factor of 100% has the highest initial installation cost, comparing all the buildings, it takes at most two months and two days to reach the breakeven point.

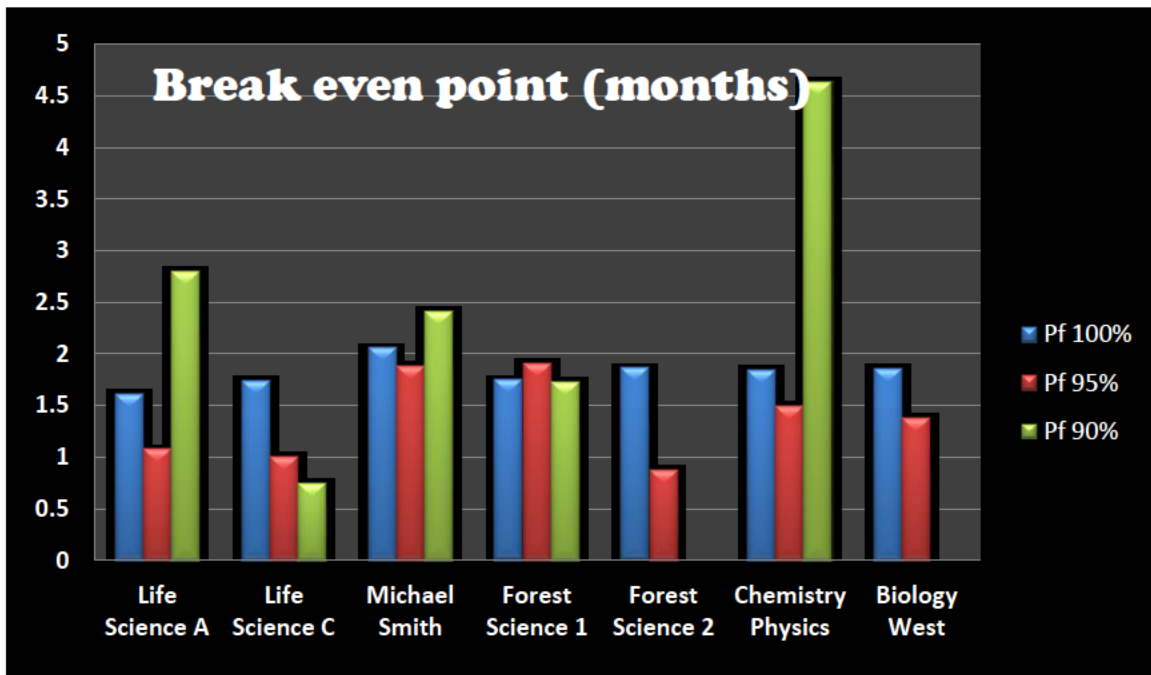

Figure 6: Breakeven point in number of months

#### **4.5 Operational Life Improvement**

Since the improvement of the power factor will result in a decrease in the hottest temperature of the transformer, the operational life expectancy of the transformer will also improve. It can be concluded from Figure 7 that the average increase in the life of the transformers is three years and nine months for 50% loading and initial life expectancy of 25 years. With the transformer from Michael Smith building at the highest improvement at 5 years and seven months, and the

lowest improvement of 2 years and one month for Forest Science 2 transformer, the installation of the capacitor is actually an excellent initiative.

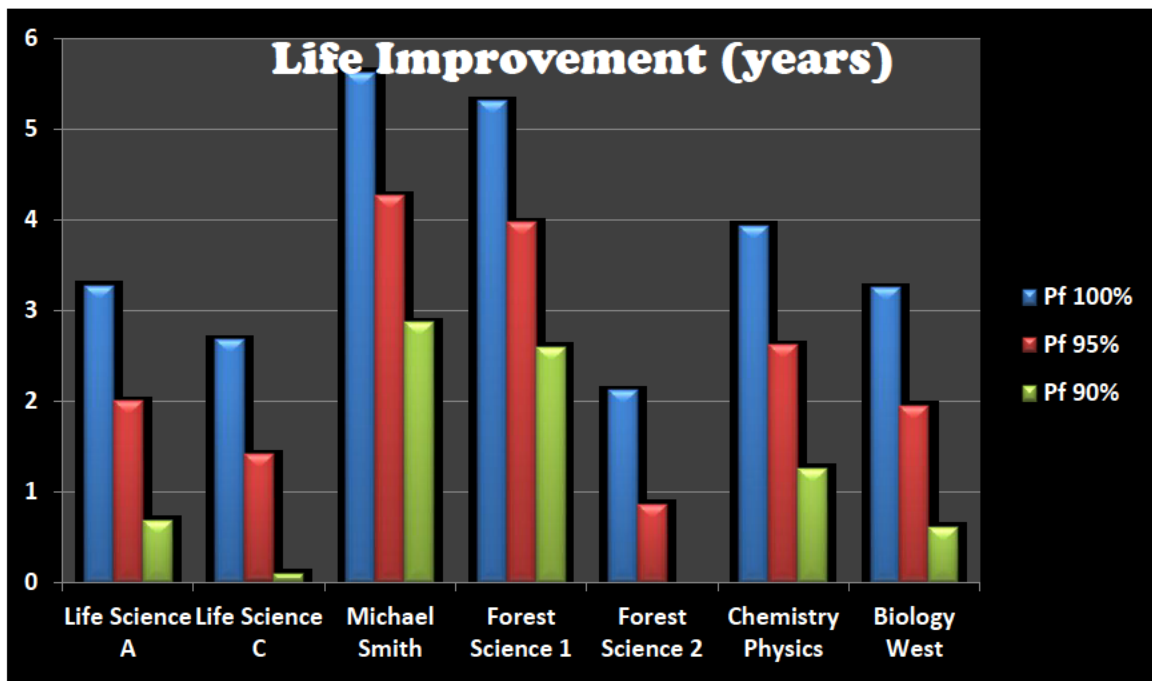

Figure 7: Operational life of the transformer after the addition of the capacitors

The overall objective of the project was to recommend power factor improving equipment and the estimation of the capital savings as a result of the installation. I have been able to accomplish all the objectives set during the proposal. In addition I was able to estimate the life expectancy improvements that the bank of capacitors will provide for the transformer. Even though, in the beginning I had difficulty calculating the hottest temperature of the system, with immense amount of research as well as assistance from Dr. Paul Lusina, I was able to manage to find the life expectancy improvement of the transformers using equation 4. I recommend using the findings from this project to estimate a total savings if the installation was done for all the buildings on campus. Furthermore, the change in net present value overtime should be considered while finding the breakeven point.

## 5.0 CONCLUSION

This report investigated the possibility of power factor improvements for the following five UBC buildings: Life Science, Biology West, Chemistry Physics, Forest Science and Michael Smith. I was able to inspect the capacitor installations, the capital savings, and the life expectancy improvements as a result of the installation of the capacitors. By using Microsoft Excel sheets, I was also able to formulate my calculation so that the program will be able to run for different initial values.

Analyzing various options for power improvement equipment, I recommend using switched harmonic filters and breakers. This particular breaker will ensure that overcorrection of the power factor as well as harmonic resonance, which can be damaging to the transformer, is avoided. Furthermore, depending on the initial investment, I highly recommend improving to power factor of 100%. Although the installation of the capacitance of the 100% power factor is costly, the savings exceed the cost enormously. With breakeven points of less than three months, it is apparent that the return on investment starts shortly after the installation. The maintenance costs for the power factor equipment and the preventative maintenance costs from the reduction temperature are not included in this project.

With over 60 institutional buildings on campus, initiating a power improvement plan will save UBC more than \$7,000,000 within the first year, assuming that the other buildings will only save as much as Forest Science 2 . For future projects, I would recommend investigating the savings the installation of capacitors will have if it was done for all the buildings on campus, while taking into account the net present value.

## REFERENCE

[1]”UBC Sustainability remote metering site”, cited winter 2013, available from World Wide

Web: <<http://utilsub.lbs.ubc.ca/ion/>>

[2]Brahm Segal, “Costs and benefits of harmonic current and power factor reduction for variable speed drives in an industrial facility”, Power Correction Systems, Inc., August 28, 2000[cited March 2013], available from World Wide Web:

< [www.activeharmonicfilters.com/Tutorial/pcs-tutorial.doc](http://www.activeharmonicfilters.com/Tutorial/pcs-tutorial.doc)>

[3] “Power factor Capacitors and harmonic filters”,EATON, September 2011[cited on March 2013], available from World Wide Web: <<http://eaton.com/consultants>>

[4]”Application of power factor correction capacitors”,Teknatool international corp.,2012[cited on

March 2013], available from World Wide Web:

<<http://www.teknaool.com/products/Lathes/DVR/downloads/How%20Power%20Factor%20corection%20works.pdf>>

[5]Leo L. Grigsby,” Electric power transformer engineering”, CRC Press LLC,2004 [cited on March 2013],available from World Wide Web:

<<http://www.uncp.edu.pe/newfacultades/ingenieriasarqui/newelectrica/phocadownload/descargas/E%20BOOK%20Electric%20Power%20Transformer%20Engineering.pdf>>

[6] “Power rating”,Wikipedia,Feb 2013[cited on March 2013], available form World Wide Web:

<[http://en.wikipedia.org/wiki/Power\\_rating](http://en.wikipedia.org/wiki/Power_rating)>



## APPENDIX

[1] Phasor diagram showing the relationship between apparent power, reactive power, and real(true) power

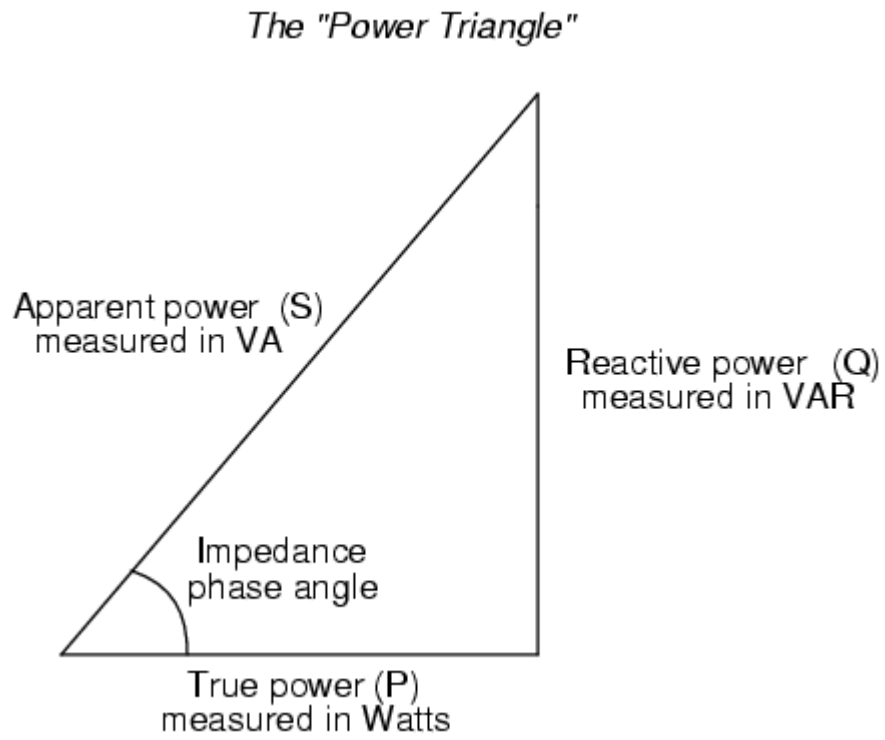

[2]Table of desired power factor[5]

	80	81	82	83	84	85	86	87	88	89	90	91	92	93	94	95	96	97	98	99	100
50	0.982	1.008	1.034	1.060	1.086	1.112	1.139	1.165	1.192	1.220	1.248	1.276	1.306	1.337	1.369	1.403	1.442	1.481	1.529	1.590	1.732
51	.937	.962	.989	1.015	1.041	1.067	1.094	1.120	1.147	1.175	1.203	1.231	1.261	1.292	1.324	1.358	1.395	1.436	1.484	1.544	1.687
52	.893	.919	.945	.971	.997	1.023	1.050	1.076	1.103	1.131	1.159	1.187	1.217	1.248	1.280	1.314	1.351	1.392	1.440	1.500	1.643
53	.850	.876	.902	.928	.954	.980	1.007	1.033	1.060	1.088	1.116	1.144	1.174	1.205	1.237	1.271	1.308	1.349	1.397	1.457	1.600
54	.809	.835	.861	.887	.913	.939	.966	.992	1.019	1.047	1.075	1.103	1.133	1.164	1.196	1.230	1.267	1.308	1.356	1.416	1.559
55	.769	.795	.821	.847	.873	.899	.926	.952	.979	1.007	1.035	1.063	1.090	1.124	1.156	1.190	1.228	1.268	1.316	1.377	1.519
56	.730	.756	.782	.808	.834	.860	.887	.913	.940	.968	.996	1.024	1.051	1.085	1.117	1.151	1.189	1.229	1.277	1.338	1.480
57	.692	.718	.744	.770	.796	.822	.849	.875	.902	.930	.958	.986	1.013	1.047	1.079	1.113	1.151	1.191	1.239	1.300	1.442
58	.655	.681	.707	.733	.759	.785	.812	.838	.865	.893	.921	.949	.976	1.010	1.042	1.076	1.114	1.154	1.202	1.263	1.405
59	.618	.644	.670	.696	.722	.748	.775	.801	.828	.856	.884	.912	.939	.973	1.005	1.039	1.077	1.117	1.165	1.226	1.368
60	.584	.610	.636	.662	.688	.714	.741	.767	.794	.822	.850	.878	.905	.939	.971	1.005	1.043	1.083	1.131	1.192	1.334
61	.549	.575	.601	.627	.653	.679	.706	.732	.759	.787	.815	.843	.870	.904	.936	.970	1.008	1.048	1.096	1.157	1.299
62	.515	.541	.567	.593	.619	.645	.672	.698	.725	.753	.781	.809	.836	.870	.902	.936	.974	1.014	1.062	1.123	1.265
63	.483	.509	.535	.561	.587	.613	.640	.666	.693	.721	.749	.777	.804	.838	.870	.904	.942	.982	1.030	1.091	1.233
64	.450	.476	.502	.528	.554	.580	.607	.633	.660	.688	.716	.744	.771	.805	.837	.871	.909	.949	.997	1.058	1.200
65	.419	.445	.471	.497	.523	.549	.576	.602	.629	.657	.685	.713	.740	.774	.806	.840	.878	.918	.966	1.027	1.169
66	.388	.414	.440	.466	.492	.518	.545	.571	.598	.626	.654	.682	.709	.743	.775	.809	.847	.887	.935	.996	1.138
67	.358	.384	.410	.436	.462	.488	.515	.541	.568	.596	.624	.652	.679	.713	.745	.779	.817	.857	.905	.966	1.108
68	.329	.355	.381	.407	.433	.459	.486	.512	.539	.567	.595	.623	.650	.684	.716	.750	.788	.828	.876	.937	1.079
69	.299	.325	.351	.377	.403	.429	.456	.482	.509	.537	.565	.593	.620	.654	.686	.720	.758	.798	.840	.901	1.049
70	.270	.296	.322	.348	.374	.400	.427	.453	.480	.508	.536	.564	.591	.625	.657	.691	.729	.769	.811	.876	1.020
71	.242	.268	.294	.320	.346	.372	.399	.425	.452	.480	.508	.536	.563	.597	.629	.663	.701	.741	.783	.850	.992
72	.213	.239	.265	.291	.317	.343	.370	.396	.423	.451	.479	.507	.534	.568	.600	.634	.672	.712	.754	.821	.963
73	.186	.212	.238	.264	.290	.316	.343	.369	.396	.424	.452	.480	.507	.541	.573	.607	.645	.685	.727	.794	.936
74	.159	.185	.211	.237	.263	.289	.316	.342	.369	.397	.425	.453	.480	.514	.546	.580	.618	.658	.700	.767	.909
75	.132	.158	.184	.210	.236	.262	.289	.315	.342	.370	.398	.426	.453	.487	.519	.553	.591	.631	.673	.740	.882
76	.105	.131	.157	.183	.209	.235	.262	.288	.315	.343	.371	.399	.426	.460	.492	.526	.564	.604	.652	.713	.855
77	.079	.105	.131	.157	.183	.209	.236	.262	.289	.317	.345	.373	.400	.434	.466	.500	.538	.578	.620	.687	.829
78	.053	.079	.105	.131	.157	.183	.210	.236	.263	.291	.319	.347	.374	.408	.440	.474	.512	.552	.594	.661	.803
79	.026	.052	.078	.104	.130	.156	.183	.209	.236	.264	.292	.320	.347	.381	.413	.447	.485	.525	.567	.634	.776
80	.000	.026	.052	.078	.104	.130	.157	.183	.210	.238	.266	.294	.321	.355	.387	.421	.459	.499	.541	.608	.750
81	----	.000	.026	.052	.078	.104	.131	.157	.184	.212	.240	.268	.295	.329	.361	.395	.433	.473	.515	.582	.724
82	----	----	.000	.026	.052	.078	.105	.131	.158	.186	.214	.242	.269	.303	.335	.369	.407	.447	.489	.556	.698
83	----	----	----	.000	.026	.052	.079	.105	.132	.160	.188	.216	.243	.277	.309	.343	.381	.421	.463	.530	.672

84	---	---	---	---	.000	.026	.053	.079	.106	.134	.162	.190	.217	.251	.283	.317	.355	.395	.437	.504	.645
85	---	---	---	---	---	.000	.027	.053	.080	.108	.136	.164	.191	.225	.257	.291	.329	.369	.417	.478	.620
86	---	---	---	---	---	---	.026	.026	.053	.081	.109	.137	.167	.198	.230	.265	.301	.343	.390	.451	.593
87	---	---	---	---	---	---	---	---	.027	.055	.082	.111	.141	.172	.204	.238	.275	.317	.364	.425	.567
88	---	---	---	---	---	---	---	---	---	.028	.056	.084	.114	.145	.177	.211	.248	.290	.337	.398	.540
89	---	---	---	---	---	---	---	---	---	---	.028	.056	.086	.117	.149	.183	.220	.262	.309	.370	.512
90	---	---	---	---	---	---	---	---	---	---	---	.028	.058	.089	.121	.155	.192	.234	.281	.342	.484
91	---	---	---	---	---	---	---	---	---	---	---	---	.030	.061	.093	.127	.164	.206	.253	.314	.456
92	---	---	---	---	---	---	---	---	---	---	---	---	---	.031	.063	.097	.134	.176	.223	.284	.426
93	---	---	---	---	---	---	---	---	---	---	---	---	---	---	.032	.066	.103	.145	.192	.253	.395
94	---	---	---	---	---	---	---	---	---	---	---	---	---	---	---	.034	.071	.113	.160	.221	.363
95	---	---	---	---	---	---	---	---	---	---	---	---	---	---	---	---	.037	.079	.126	.187	.328
96	---	---	---	---	---	---	---	---	---	---	---	---	---	---	---	---	---	.042	.089	.150	.292
97	---	---	---	---	---	---	---	---	---	---	---	---	---	---	---	---	---	---	.047	.108	.251
98	---	---	---	---	---	---	---	---	---	---	---	---	---	---	---	---	---	---	---	.061	.203
99	---	---	---	---	---	---	---	---	---	---	---	---	---	---	---	---	---	---	---	---	.142

[3] Life Science A

	Pf of 100%	Pf of 95%	Pf of 90%
Closest common size capacitor (KVAR)	120	50	15
Average capacitor size for correction( KVAR)	116.2065338	45.33190001	22.28974058
Component sizing( V)	600	600	600
Breaker sizing(A)	250	250	250
Max bus load % rise at no load	0.46	0.19	0.06
parallel resonance at 200KVAR	14.74	22.84	41.7
Fixed harmonic filter and breaker(\$)	6600	2750	825
Switched harmonic filter and breaker(\$)	9000	3750	1125
Fixed cap and breaker(\$)	X	X	375
Switched cap and breaker(\$)	X	X	750
Electrical yearly savings	67466.64	42029.75	4858.326
GHG yearly savings	158.0527	66.60427	23.30175
Total yearly savings	67624.69	42096.35	4881.627
Fixed harmonic filter and breaker B/E	1.187436	0.794804	2.056179
Switched harmonic filter and breaker B/E	1.619231	1.083823	2.803881
Fixed cap and breaker B/E	X	X	0.934627
Switched cap and breaker B/E	X	X	1.869254

Table of breaker's information and installation costs

	Life improvement	Pf of 100%	Pf of 95%	Pf of 90%
	Average	28.28285	27.00019	25.68313
80% loading (25 years)	Maximum	32.88638	31.5116	30.08967
	Minimum	26.63028	25.37529	24.08989
	Standard deviation	1.155452	1.136847	1.115456
	Average	45.25257	43.2003	41.09301
50% loading (40 years)	Maximum	52.6182	50.41855	48.14347
	Minimum	42.60845	40.60046	38.54383
	Standard deviation	1.848723	1.818955	1.78473

Life expectancy improvements

### Life Science C

	Pf of 100%	Pf of 95%	Pf of 90%
Closest common size capacitor (KVAR)	150	50	5
Average capacitor size for correction( KVAR)	145.0079316	49.22894139	19.97271629
Component sizing( V)	600	600	600
Breaker sizing(A)	250	250	250
Max bus load % rise at no load	0.58	0.19	0.02
Parallel resonance at 200KVAR	13.19	22.84	72.23
Fxed harmonic filter and breaker(\$)	8250	2750	275
Switched harmonic filter and breaker(\$)	11250	3750	375
Fixed cap and breaker(\$)	X	X	125
Switched cap and breaker(\$)	X	X	250
Electrical yearly savings	67466.64	42029.75	4858.326
Electrical yearly savings	78226.6	45005.89	6054.6
GHG yearly savings	188.0065	69.27128	13.04797
Total yearly savings	78414.6	45075.16	6067.648
Fixed harmonic filter and breaker B/E	1.280055	0.742279	0.551422
Switched harmonic filter and breaker B/E	1.745529	1.012198	0.751939
Fixed cap and breaker B/E	X	X	0.250646

Table of breaker's information and installation costs

	<b>Life improvement</b>	<b>Pf of 100%</b>	<b>Pf of 95%</b>	<b>Pf of 90%</b>
	Average	27.68488	26.40604	25.09395
80% loading (25 years)	Maximum	29.22294	27.9158	26.5715
	Minimum	26.20307	24.95349	23.67444
	Standard deviation	0.769466	0.755921	0.740474
	Average	44.29581	42.24966	40.15032
50% loading (40 years)	Maximum	46.7567	44.66528	42.5144
	Minimum	41.92492	39.92558	37.8791
	Standard deviation	1.231146	1.209474	1.184758

Life expectancy improvements

**Michael Smith**

	Pf of 100%	Pf of 95%	Pf of 90%
Closest common size capacitor (KVAR)	500	300	160
Average capacitor size for correction( KVAR)	552.3592	302.1452	202.404
Component sizing( V)	600	600	600
Breaker sizing(A)	800	400	250
Max bus load % rise at no load	1.95	1.16	0.62
Parallel resonance at 200KVAR	7.22	9.33	12.77
Fixed harmonic filter and breaker(\$)	27500	16500	8800
Switched harmonic filter and breaker(\$)	37500	22500	12000
Fixed cap and breaker(\$)	X	7500	X
Switched cap and breaker(\$)	X	15000	X
Electrical yearly savings	220329.6	144844.2	60108.29
Electrical yearly savings	574.978	314.8985	191.7461
GHG yearly savings	220904.6	145159.1	60300.03
Total yearly savings	1.514606	1.382965	1.775566
Fixed harmonic filter and breaker B/E	2.065371	1.885861	2.421226
Switched harmonic filter and breaker B/E	X	0.62862	X
Fixed cap and breaker B/E	X	1.257241	X

Table of breaker's information and installation costs



	Life improvement	Pf of 100%	Pf of 95%	Pf of 90%
	Average	30.63168	29.27402	27.8739
80% loading (25 years)	Maximum	32.78393	31.38749	29.9426
	Minimum	28.12362	26.81553	25.47197
	Standard deviation	1.53386	1.505296	1.472468
	Average	49.01068	46.83843	44.59824
50% loading (40 years)	Maximum	52.45429	50.21999	47.90816
	Minimum	44.9978	42.90484	40.75515
	Standard deviation	2.454177	2.408474	2.355948

Life expectancy improvements

## **Forest Science 1**

	<b>Pf of 100%</b>	<b>Pf of 95%</b>	<b>Pf of 90%</b>
Closest common size capacitor (KVAR)	200	120	65
Average capacitor size for correction( KVAR)	186.3299	101.9334	62.16566
Component sizing( V)	600	600	600
Breaker sizing(A)	400	250	250
Max bus load % rise at no load	0.77	0.46	0.25
Parallel resonance at 200KVAR	11.42	14.74	20.03
Fixed harmonic filter and breaker(\$)	11000	6600	3575
Switched harmonic filter and breaker(\$)	15000	9000	4875
Fixed cap and breaker(\$)	X	X	X
Switched cap and breaker(\$)	X	X	X
Electrical yearly savings	103197	56166.9	33897.3
Electrical yearly savings	1063.76	955.414	351.61
GHG yearly savings	104261	57122.3	34248.9
Total yearly savings	1.28364	1.40576	1.26999
Fixed harmonic filter and breaker B/E	1.75042	1.91694	1.73181
Switched harmonic filter and breaker B/E	X	X	X
Fixed cap and breaker B/E	X	X	X

Table of breaker's information and installation costs

	<b>Life improvement</b>	<b>Pf of 100%</b>	<b>Pf of 95%</b>	<b>Pf of 90%</b>
	Average	30.3194	28.9822	27.6044
80% loading (25 years)	Maximum	31.3528	30.0048	28.6138
	Minimum	28.7975	27.4877	26.1411
	Standard deviation	0.47948	0.47292	0.46521
	Average	48.5111	46.3716	44.167
50% loading (40 years)	Maximum	50.1645	48.0076	45.782
	Minimum	46.0761	43.9802	41.8258
	Standard deviation	0.76717	0.75667	0.74434

Life expectancy improvements

## **Forest Science 2**

	<b>Pf of 100%</b>	<b>Pf of 95%</b>	<b>Pf of 90%</b>
Closest common size capacitor (KVAR)	120	27.5	15
Average capacitor size for correction( KVAR)	123.842	35.8663	5.77335
Component sizing( V)	600	600	600
Breaker sizing(A)	250	250	250
Max bus load % rise at no load	0.46	0.11	0.06
Parallel resonance at 200KVAR	14.74	30.8	41.7
Fixed harmonic filter and breaker(\$)	6600	1513	825
Switched harmonic filter and breaker(\$)	9000	2063	1125
Fixed cap and breaker(\$)	X	688	375
Switched cap and breaker(\$)	X	1375	750
Electrical yearly savings	58452.9	28446.7	-6011.1
Electrical yearly savings	144.295	39.0387	-10.802
GHG yearly savings	58597.2	28485.7	-6021.9
Total yearly savings	1.37037	0.64622	-1.6668
Fixed harmonic filter and breaker B/E	1.86869	0.88114	-2.2729
Switched harmonic filter and breaker B/E	X	0.29385	-0.7576
Fixed cap and breaker B/E	X	0.58728	-1.5153

Table of breaker's information and installation costs

	Life improvement	Pf of 100%	Pf of 95%	Pf of 90%
	Average	27.1203	25.8591	24.5663
80% loading (25 years)	Maximum	27.9202	26.6435	25.3333
	Minimum	26.2558	25.0086	23.7319
	Standard deviation	0.50048	0.49286	0.48409
	Average	43.3925	41.3745	39.3061
50% loading (40 years)	Maximum	44.6724	42.6296	40.5333
	Minimum	42.0093	40.0137	37.971
	Standard deviation	0.80077	0.78857	0.77455

Life expectancy improvements

**Chemistry Physics**

	Pf of 100%	Pf of 95%	Pf of 90%
Closest common size capacitor (KVAR)	300	140	65
Average capacitor size for correction( KVAR)	296.421	134.919	58.5895
Component sizing( V)	600	600	600
Breaker sizing(A)	400	250	250
Max bus load % rise at no load	0.87	0.4	0.19
Parallel resonance at 200KVAR	10.77	15.76	23.13
Fixed harmonic filter and breaker(\$)	16500	7700	3575
Switched harmonic filter and breaker(\$)	22500	10500	4875
Fixed cap and breaker(\$)	X	X	X
Switched cap and breaker(\$)	X	X	X
Electrical yearly savings	147242	84800.3	12720.7
Electrical yearly savings	381.779	163.655	60.3698
GHG yearly savings	147624	84963.9	12781.1
Total yearly savings	1.35988	1.10262	3.40313
Fixed harmonic filter and breaker B/E	1.85438	1.50358	4.64063
Switched harmonic filter and breaker B/E	X	X	X
Fixed cap and breaker B/E	X	X	X

Table of breaker's information and installation costs

	Life improvement	Pf of 100%	Pf of 95%	Pf of 90%
	Average	28.9394	27.6191	26.2614
80% loading (25 years)	Maximum	29.7046	28.3699	26.9957
	Minimum	27.9712	26.6707	25.3353
	Standard deviation	0.5036	0.49386	0.48276
	Average	46.303	44.1906	42.0182
50% loading (40 years)	Maximum	47.5274	45.3918	43.1931
	Minimum	44.754	42.6731	40.5364
	Standard deviation	0.80576	0.79017	0.77242

Life expectancy improvements

**Biology West**

	Pf of 100%	Pf of 95%	Pf of 90%
Closest common size capacitor (KVAR)	350	140	40
Average capacitor size for correction( KVAR)	328.847	128.818	47.9936
Component sizing( V)	600	600	600
Breaker sizing(A)	600	250	250
Max bus load % rise at no load	1.02	0.4	0.12
Parallel resonance at 200KVAR	9.97	15.76	29.49
Fixed harmonic filter and breaker(\$)	19250	7700	2200
Switched harmonic filter and breaker(\$)	26250	10500	3000
Fixed cap and breaker(\$)	8750	X	1000
Switched cap and breaker(\$)	17500	X	2000
Electrical yearly savings	170924	91947.1	-5043.3
Electrical yearly savings	448.482	167.132	33.9078
GHG yearly savings	171372	92114.2	-5009.4
Total yearly savings	1.36666	1.01703	-5.3433
Fixed harmonic filter and breaker B/E	1.86363	1.38687	-7.2863
Switched harmonic filter and breaker B/E	0.62121	X	-2.4288
Fixed cap and breaker B/E	1.24242	X	-4.8575

Table of breaker's information and installation costs



	Life improvement	Pf of 100%	Pf of 95%	Pf of 90%
	Average	28.2625	26.9549	25.6117
80% loading (25 years)	Maximum	29.0515	27.7275	26.3656
	Minimum	27.5315	26.2403	24.9156
	Standard deviation	0.46074	0.45109	0.44019
	Average	45.22	43.1278	40.9787
50% loading (40 years)	Maximum	46.4825	44.3639	42.1849
	Minimum	44.0504	41.9846	39.8649
	Standard deviation	0.73718	0.72175	0.7043

Life expectancy improvements